

DATA SHEET

74F02

Quad 2-input NOR gate

Product specification

1990 Oct 04

IC15 Data Handbook

Quad 2-input NOR gate

74F02

FEATURE

- Industrial temperature range available (-40°C to +85°C)

TYPE	TYPICAL PROPAGATION DELAY	TYPICAL SUPPLY CURRENT (TOTAL)
74F02	3.4ns	4.4mA

PIN CONFIGURATION

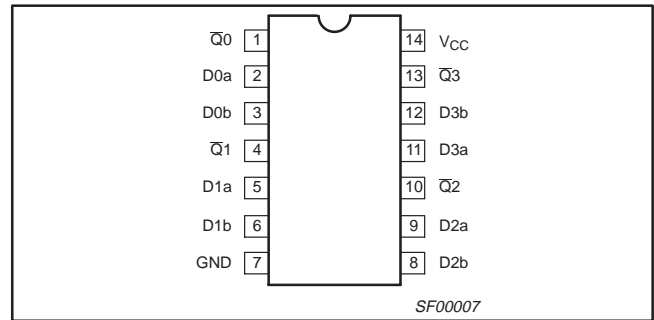

ORDERING INFORMATION

DESCRIPTION	ORDER CODE		PKG DWG #
	COMMERCIAL RANGE V _{CC} = 5V ±10%, T _{amb} = 0°C to +70°C	INDUSTRIAL RANGE V _{CC} = 5V ±10%, T _{amb} = -40°C to +85°C	
14-pin plastic DIP	N74F02N	I74F02N	SOT27-1
14-pin plastic SO	N74F02D	I74F02D	SOT108-1

INPUT AND OUTPUT LOADING AND FAN-OUT TABLE

PINS	DESCRIPTION	74F (U.L.) HIGH/LOW	LOAD VALUE HIGH/LOW
Dna, Dnb	Data inputs	1.0/1.0	20µA/0.6mA
Qn	Data output	50/33	1.0mA/20mA

NOTE:

One (1.0) FAST unit load is defined as: 20µA in the high state and 0.6mA in the low state.

LOGIC DIAGRAM

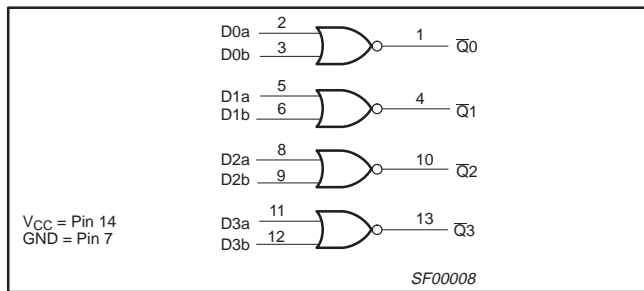

FUNCTION TABLE

INPUTS		OUTPUT
Dna	Dnb	Qn
L	L	H
L	H	L
H	L	L
H	H	L

NOTES:

- H = High voltage level
- L = Low voltage level

LOGIC SYMBOL

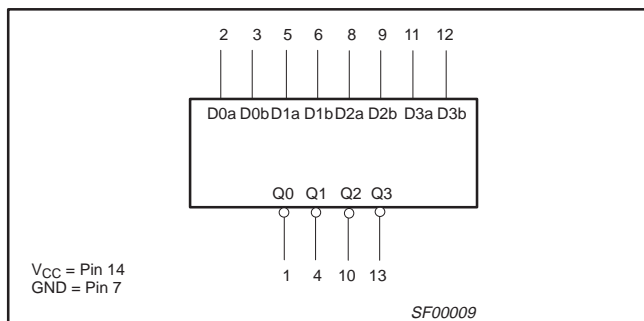

IEC/IEEE SYMBOL

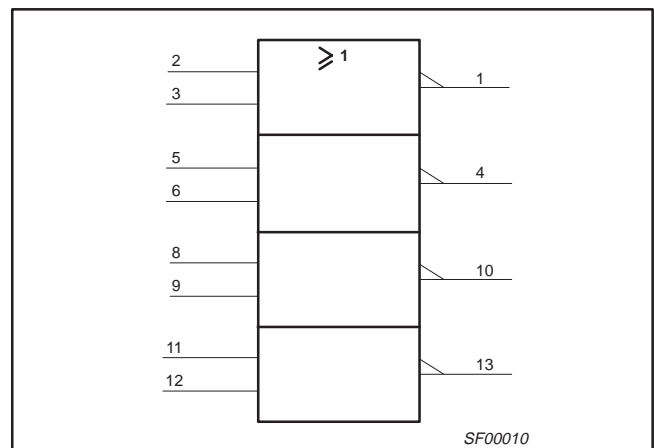

Quad 2-input NOR gate

74F02

ABSOLUTE MAXIMUM RATINGS

(Operation beyond the limit set forth in this table may impair the useful life of the device.
Unless otherwise noted these limits are over the operating free air temperature range.)

SYMBOL	PARAMETER		RATING	UNIT
V_{CC}	Supply voltage		-0.5 to +7.0	V
V_{IN}	Input voltage		-0.5 to +7.0	V
I_{IN}	Input current		-30 to +5	mA
V_{OUT}	Voltage applied to output in high output state		-0.5 to V_{CC}	V
I_{OUT}	Current applied to output in low output state		40	mA
T_{amb}	Operating free air temperature range	Commercial range	0 to +70	°C
		Industrial range	-40 to +85	°C
T_{stg}	Storage temperature range		-65 to +150	°C

RECOMMENDED OPERATING CONDITIONS

SYMBOL	PARAMETER	LIMITS			UNIT
		MIN	NOM	MAX	
V_{CC}	Supply voltage	4.5	5.0	5.5	V
V_{IH}	High-level input voltage	2.0			V
V_{IL}	Low-level input voltage			0.8	V
I_{IK}	Input clamp current			-18	mA
I_{OH}	High-level output current			-1	mA
I_{OL}	Low-level output current			20	mA
T_{amb}	Operating free air temperature range	Commercial range	0	+70	°C
		Industrial range	-40	+85	°C

DC ELECTRICAL CHARACTERISTICS

(Over recommended operating free-air temperature range unless otherwise noted.)

SYMBOL	PARAMETER	TEST CONDITIONS ¹	LIMITS			UNIT	
			MIN	TYP ²	MAX		
V_{OH}	High-level output voltage	$V_{CC} = \text{MIN}, V_{IL} = \text{MAX}$	$\pm 10\%V_{CC}$	2.5		V	
		$V_{IH} = \text{MIN}, I_{OH} = \text{MAX}$	$\pm 5\%V_{CC}$	2.7	3.4	V	
V_{OL}	Low-level output voltage	$V_{CC} = \text{MIN}, V_{IL} = \text{MAX}$	$\pm 10\%V_{CC}$		0.30	0.50	V
		$V_{IH} = \text{MIN}, I_{OI} = \text{MAX}$	$\pm 5\%V_{CC}$		0.30	0.50	V
V_{IK}	Input clamp voltage	$V_{CC} = \text{MIN}, I_I = I_{IK}$		-0.73	-1.2	V	
I_I	Input current at maximum input voltage	$V_{CC} = \text{MAX}, V_I = 7.0\text{V}$			100	μA	
I_{IH}	High-level input current	$V_{CC} = \text{MAX}, V_I = 2.7\text{V}$			20	μA	
I_{IL}	Low-level input current	$V_{CC} = \text{MAX}, V_I = 0.5\text{V}$			-0.6	mA	
I_{OS}	Short-circuit output current ³	$V_{CC} = \text{MAX}$	-60		-150	mA	
I_{CC}	Supply current (total) ⁴	I_{CCH}	$V_{CC} = \text{MAX}$		3.0	5.6	mA
		I_{CCL}	$V_{CC} = \text{MAX}$		7.0	13.0	mA

NOTES:

- For conditions shown as MIN or MAX, use the appropriate value specified under recommended operating conditions for the applicable type.
- All typical values are at $V_{CC} = 5\text{V}$, $T_{amb} = 25^\circ\text{C}$.
- Not more than one output should be shorted at a time. For testing I_{OS} , the use of high-speed test apparatus and/or sample-and-hold techniques are preferable in order to minimize internal heating and more accurately reflect operational values. Otherwise, prolonged shorting of a high output may raise the chip temperature well above normal and thereby cause invalid readings in other parameter tests. In any sequence of parameter tests, I_{OS} tests should be performed last.
- I_{CC} is measured with outputs open.

Quad 2-input NOR gate

74F02

AC ELECTRICAL CHARACTERISTICS

SYMBOL	PARAMETER	TEST CONDITION	LIMITS						UNIT	
			$V_{CC} = +5.0V$ $T_{amb} = +25^{\circ}C$ $C_L = 50pF, R_L = 500\Omega$			$V_{CC} = +5.0V \pm 10\%$ $T_{amb} = 0^{\circ}C \text{ to } +70^{\circ}C$ $C_L = 50pF, R_L = 500\Omega$		$V_{CC} = +5.0V \pm 10\%$ $T_{amb} = -40^{\circ}C \text{ to } +85^{\circ}C$ $C_L = 50pF, R_L = 500\Omega$		
			MIN	TYP	MAX	MIN	MAX	MIN		MAX
t_{PLH} t_{PHL}	Propagation delay Dna, Dnb to \bar{Q}_n	Waveform 1	2.5 2.0	4.4 3.2	5.5 4.3	2.5 2.0	6.5 5.3	2.5 1.5	7.0 6.0	ns

AC WAVEFORMS

For all waveforms, $V_M = 1.5V$.

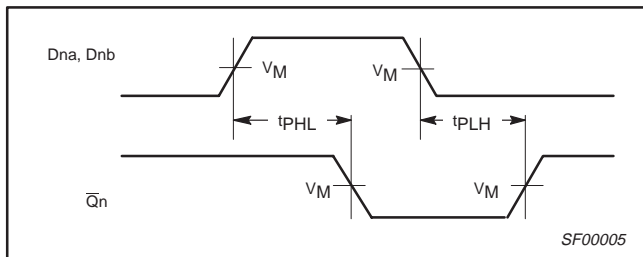

Waveform 1. Propagation delay for inverting outputs

TEST CIRCUIT AND WAVEFORM

Test Circuit for Totem-Pole Outputs

Input Pulse Definition

DEFINITIONS:

- R_L = Load resistor; see AC ELECTRICAL CHARACTERISTICS for value.
- C_L = Load capacitance includes jig and probe capacitance; see AC ELECTRICAL CHARACTERISTICS for value.
- R_T = Termination resistance should be equal to Z_{OUT} of pulse generators.

family	INPUT PULSE REQUIREMENTS					
	amplitude	V_M	rep. rate	t_w	t_{TLH}	t_{THL}
74F	3.0V	1.5V	1MHz	500ns	2.5ns	2.5ns

SF00006

Quad 2-input NOR gate

74F02

DIP14: plastic dual in-line package; 14 leads (300 mil)

SOT27-1



DIMENSIONS (inch dimensions are derived from the original mm dimensions)

UNIT	A max.	A ₁ min.	A ₂ max.	b	b ₁	c	D ⁽¹⁾	E ⁽¹⁾	e	e ₁	L	M _E	M _H	w	Z ⁽¹⁾ max.
mm	4.2	0.51	3.2	1.73 1.13	0.53 0.38	0.36 0.23	19.50 18.55	6.48 6.20	2.54	7.62	3.60 3.05	8.25 7.80	10.0 8.3	0.254	2.2
inches	0.17	0.020	0.13	0.068 0.044	0.021 0.015	0.014 0.009	0.77 0.73	0.26 0.24	0.10	0.30	0.14 0.12	0.32 0.31	0.39 0.33	0.01	0.087

Note

1. Plastic or metal protrusions of 0.25 mm maximum per side are not included.

OUTLINE VERSION	REFERENCES			EUROPEAN PROJECTION	ISSUE DATE
	IEC	JEDEC	EIAJ		
SOT27-1	050G04	MO-001AA			92-11-17 95-03-11

Quad 2-input NOR gate

74F02

SO14: plastic small outline package; 14 leads; body width 3.9 mm

SOT108-1



DIMENSIONS (inch dimensions are derived from the original mm dimensions)

UNIT	A max.	A ₁	A ₂	A ₃	b _p	c	D ⁽¹⁾	E ⁽¹⁾	e	H _E	L	L _p	Q	v	w	y	z ⁽¹⁾	θ
mm	1.75	0.25 0.10	1.45 1.25	0.25	0.49 0.36	0.25 0.19	8.75 8.55	4.0 3.8	1.27	6.2 5.8	1.05	1.0 0.4	0.7 0.6	0.25	0.25	0.1	0.7 0.3	8° 0°
inches	0.069	0.010 0.004	0.057 0.049	0.01	0.019 0.014	0.0100 0.0075	0.35 0.34	0.16 0.15	0.050	0.244 0.228	0.041	0.039 0.016	0.028 0.024	0.01	0.01	0.004	0.028 0.012	

Note

1. Plastic or metal protrusions of 0.15 mm maximum per side are not included.

OUTLINE VERSION	REFERENCES				EUROPEAN PROJECTION	ISSUE DATE
	IEC	JEDEC	EIAJ			
SOT108-1	076E06S	MS-012AB				95-01-23 97-05-22

Quad 2-input NOR gate

74F02

NOTES

Quad 2-input NOR gate

74F02

DIP14: plastic dual in-line package; 14 leads (300 mil)

SOT27-1



DIMENSIONS (inch dimensions are derived from the original mm dimensions)

UNIT	A max.	A ₁ min.	A ₂ max.	b	b ₁	c	D ⁽¹⁾	E ⁽¹⁾	e	e ₁	L	M _E	M _H	w	Z ⁽¹⁾ max.
mm	4.2	0.51	3.2	1.73 1.13	0.53 0.38	0.36 0.23	19.50 18.55	6.48 6.20	2.54	7.62	3.60 3.05	8.25 7.80	10.0 8.3	0.254	2.2
inches	0.17	0.020	0.13	0.068 0.044	0.021 0.015	0.014 0.009	0.77 0.73	0.26 0.24	0.10	0.30	0.14 0.12	0.32 0.31	0.39 0.33	0.01	0.087

Note

1. Plastic or metal protrusions of 0.25 mm maximum per side are not included.

OUTLINE VERSION	REFERENCES			EUROPEAN PROJECTION	ISSUE DATE
	IEC	JEDEC	EIAJ		
SOT27-1	050G04	MO-001AA			92-11-17 95-03-11

Quad 2-input NOR gate

74F02

SO14: plastic small outline package; 14 leads; body width 3.9 mm

SOT108-1

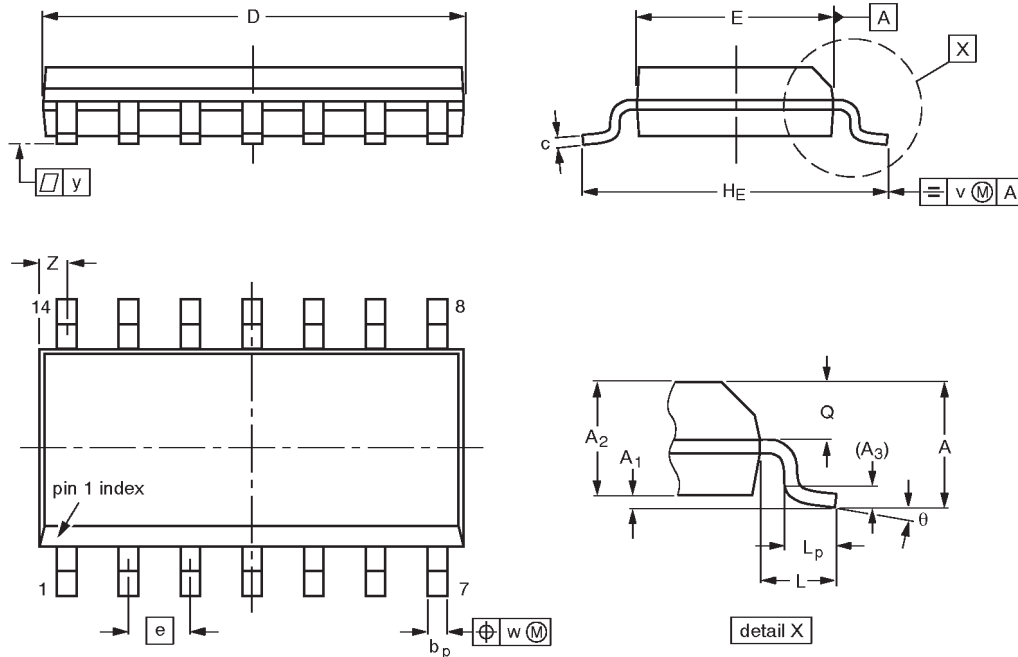

DIMENSIONS (inch dimensions are derived from the original mm dimensions)

UNIT	A max.	A ₁	A ₂	A ₃	b _p	c	D ⁽¹⁾	E ⁽¹⁾	e	H _E	L	L _p	Q	v	w	y	Z ⁽¹⁾	θ
mm	1.75	0.25 0.10	1.45 1.25	0.25	0.49 0.36	0.25 0.19	8.75 8.55	4.0 3.8	1.27	6.2 5.8	1.05	1.0 0.4	0.7 0.6	0.25	0.25	0.1	0.7 0.3	8° 0°
inches	0.069	0.0098 0.0039	0.057 0.049	0.01	0.019 0.014	0.0098 0.0075	0.35 0.34	0.16 0.15	0.050	0.24 0.23	0.041	0.039 0.016	0.028 0.024	0.01	0.01	0.004	0.028 0.012	

Note

1. Plastic or metal protrusions of 0.15 mm maximum per side are not included.

OUTLINE VERSION	REFERENCES				EUROPEAN PROJECTION	ISSUE DATE
	IEC	JEDEC	EIAJ			
SOT108-1	076E06S	MS-012AB				91-08-13 95-01-23

Quad 2-input NOR gate

74F02

NOTES

Quad 2-input NOR gate

74F02

DEFINITIONS

Data Sheet Identification	Product Status	Definition
<i>Objective Specification</i>	Formative or in Design	This data sheet contains the design target or goal specifications for product development. Specifications may change in any manner without notice.
<i>Preliminary Specification</i>	Preproduction Product	This data sheet contains preliminary data, and supplementary data will be published at a later date. Philips Semiconductors reserves the right to make changes at any time without notice in order to improve design and supply the best possible product.
<i>Product Specification</i>	Full Production	This data sheet contains Final Specifications. Philips Semiconductors reserves the right to make changes at any time without notice, in order to improve design and supply the best possible product.

Philips Semiconductors and Philips Electronics North America Corporation reserve the right to make changes, without notice, in the products, including circuits, standard cells, and/or software, described or contained herein in order to improve design and/or performance. Philips Semiconductors assumes no responsibility or liability for the use of any of these products, conveys no license or title under any patent, copyright, or mask work right to these products, and makes no representations or warranties that these products are free from patent, copyright, or mask work right infringement, unless otherwise specified. Applications that are described herein for any of these products are for illustrative purposes only. Philips Semiconductors makes no representation or warranty that such applications will be suitable for the specified use without further testing or modification.

LIFE SUPPORT APPLICATIONS

Philips Semiconductors and Philips Electronics North America Corporation Products are not designed for use in life support appliances, devices, or systems where malfunction of a Philips Semiconductors and Philips Electronics North America Corporation Product can reasonably be expected to result in a personal injury. Philips Semiconductors and Philips Electronics North America Corporation customers using or selling Philips Semiconductors and Philips Electronics North America Corporation Products for use in such applications do so at their own risk and agree to fully indemnify Philips Semiconductors and Philips Electronics North America Corporation for any damages resulting from such improper use or sale.

Philips Semiconductors
811 East Arques Avenue
P.O. Box 3409
Sunnyvale, California 94088-3409
Telephone 800-234-7381

© Copyright Philips Electronics North America Corporation 1997
 All rights reserved. Printed in U.S.A.

Let's make things better.