

**HEXFET® Power MOSFET**

- Dynamic dv/dt Rating
- Repetitive Avalanche Rated
- Isolated Central Mounting Hole
- Fast Switching
- Ease of Paralleling
- Simple Drive Requirements

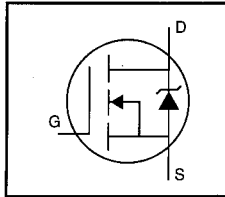

$$V_{DSS} = 450V$$

$$R_{DS(on)} = 0.63\Omega$$

$$I_D = 9.5A$$

**Description**

Third Generation HEXFETs from International Rectifier provide the designer with the best combination of fast switching, ruggedized device design, low on-resistance and cost-effectiveness.

The TO-247 package is preferred for commercial–industrial applications where higher power levels preclude the use of TO-220 devices. The TO-247 is similar but superior to the earlier TO-218 package because of its isolated mounting hole. It also provides greater creepage distance between pins to meet the requirements of most safety specifications.

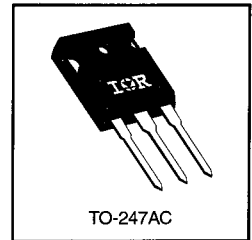

**Absolute Maximum Ratings**

	Parameter	Max.	Units
$I_D @ T_C = 25^\circ C$	Continuous Drain Current, $V_{GS} @ 10 V$	9.5	A
$I_D @ T_C = 100^\circ C$	Continuous Drain Current, $V_{GS} @ 10 V$	6.0	
$I_{DM}$	Pulsed Drain Current ①	38	
$P_D @ T_C = 25^\circ C$	Power Dissipation	150	W
	Linear Derating Factor	1.2	W/°C
$V_{GS}$	Gate-to-Source Voltage	$\pm 20$	V
$E_{AS}$	Single Pulse Avalanche Energy ②	410	mJ
$I_{AR}$	Avalanche Current ①	9.5	A
$E_{AR}$	Repetitive Avalanche Energy ①	15	mJ
dv/dt	Peak Diode Recovery dv/dt ③	3.5	V/ns
$T_J$	Operating Junction and	-55 to +150	°C
$T_{STG}$	Storage Temperature Range		
	Soldering Temperature, for 10 seconds	300 (1.6mm from case)	
	Mounting Torque, 6-32 or M3 screw	10 lbf·in (1.1 N·m)	

**Thermal Resistance**

	Parameter	Min.	Typ.	Max.	Units
$R_{\theta JC}$	Junction-to-Case	—	—	0.83	°C/W
$R_{\theta CS}$	Case-to-Sink, Flat, Greased Surface	—	0.24	—	
$R_{\theta JA}$	Junction-to-Ambient	—	—	40	

## Electrical Characteristics @ $T_J = 25^\circ\text{C}$ (unless otherwise specified)

	Parameter	Min.	Typ.	Max.	Units	Test Conditions
$V_{(BR)DSS}$	Drain-to-Source Breakdown Voltage	450	—	—	V	$V_{GS}=0V, I_D=250\mu A$
$\Delta V_{(BR)DSS}/\Delta T_J$	Breakdown Voltage Temp. Coefficient	—	0.59	—	$V/^\circ\text{C}$	Reference to $25^\circ\text{C}, I_D=1\text{mA}$
$R_{DS(on)}$	Static Drain-to-Source On-Resistance	—	—	0.63	$\Omega$	$V_{GS}=10V, I_D=5.7A$ ④
$V_{GS(th)}$	Gate Threshold Voltage	2.0	—	4.0	V	$V_{DS}=V_{GS}, I_D=250\mu A$
$g_{fs}$	Forward Transconductance	5.0	—	—	S	$V_{DS}=50V, I_D=5.7A$ ④
$I_{DSS}$	Drain-to-Source Leakage Current	—	—	25	$\mu A$	$V_{DS}=450V, V_{GS}=0V$
		—	—	250		$V_{DS}=360V, V_{GS}=0V, T_J=125^\circ\text{C}$
$I_{GSS}$	Gate-to-Source Forward Leakage	—	—	100	nA	$V_{GS}=20V$
	Gate-to-Source Reverse Leakage	—	—	-100		$V_{GS}=-20V$
$Q_g$	Total Gate Charge	—	—	80	nC	$I_D=8.8A$
$Q_{gs}$	Gate-to-Source Charge	—	—	12		$V_{DS}=360V$
$Q_{gd}$	Gate-to-Drain ("Miller") Charge	—	—	41		$V_{GS}=10V$ See Fig. 6 and 13 ④
$t_{d(on)}$	Turn-On Delay Time	—	8.7	—		ns
$t_r$	Rise Time	—	28	—	$I_D=8.8A$	
$t_{d(off)}$	Turn-Off Delay Time	—	58	—	$R_G=9.1\Omega$	
$t_f$	Fall Time	—	27	—	$R_D=25\Omega$ See Figure 10 ④	
$L_D$	Internal Drain Inductance	—	5.0	—	nH	Between lead, 6 mm (0.25in.) from package and center of die contact 
$L_S$	Internal Source Inductance	—	13	—		
$C_{iss}$	Input Capacitance	—	1400	—	pF	$V_{GS}=0V$
$C_{oss}$	Output Capacitance	—	370	—		$V_{DS}=25V$
$C_{rss}$	Reverse Transfer Capacitance	—	140	—		$f=1.0\text{MHz}$ See Figure 5

## Source-Drain Ratings and Characteristics

	Parameter	Min.	Typ.	Max.	Units	Test Conditions
$I_S$	Continuous Source Current (Body Diode)	—	—	9.5	A	MOSFET symbol showing the integral reverse p-n junction diode. 
$I_{SM}$	Pulsed Source Current (Body Diode) ①	—	—	38		
$V_{SD}$	Diode Forward Voltage	—	—	2.0	V	$T_J=25^\circ\text{C}, I_S=9.5A, V_{GS}=0V$ ④
$t_{rr}$	Reverse Recovery Time	—	490	740	ns	$T_J=25^\circ\text{C}, I_F=8.8A$
$Q_{rr}$	Reverse Recovery Charge	—	3.2	4.8	$\mu C$	$di/dt=100A/\mu s$ ④
$t_{on}$	Forward Turn-On Time	Intrinsic turn-on time is negligible (turn-on is dominated by $L_S+L_D$ )				

### Notes:

- ① Repetitive rating; pulse width limited by max. junction temperature (See Figure 11)
- ②  $V_{DD}=50V$ , starting  $T_J=25^\circ\text{C}$ ,  $L=8.1\text{mH}$ ,  $R_G=25\Omega$ ,  $I_{AS}=9.5A$  (See Figure 12)
- ③  $I_{SD}\leq 9.5A$ ,  $di/dt\leq 90A/\mu s$ ,  $V_{DD}\leq V_{(BR)DSS}$ ,  $T_J\leq 150^\circ\text{C}$
- ④ Pulse width  $\leq 300\mu s$ ; duty cycle  $\leq 2\%$ .

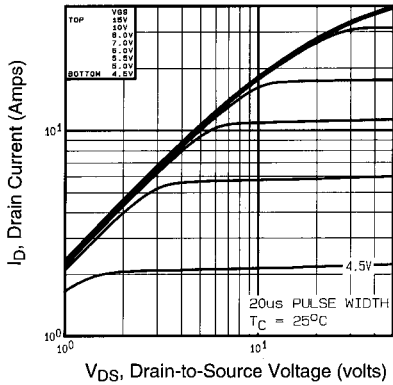

**Fig 1.** Typical Output Characteristics,  
 $T_C=25^\circ\text{C}$

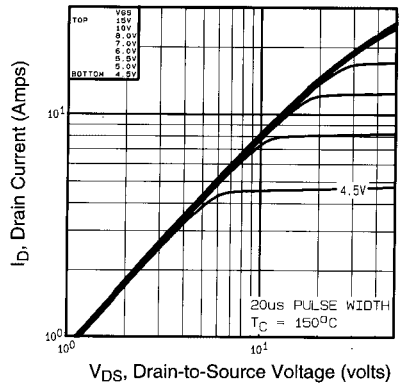

**Fig 2.** Typical Output Characteristics,  
 $T_C=150^\circ\text{C}$

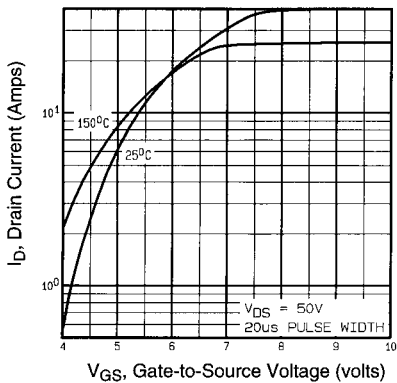

**Fig 3.** Typical Transfer Characteristics

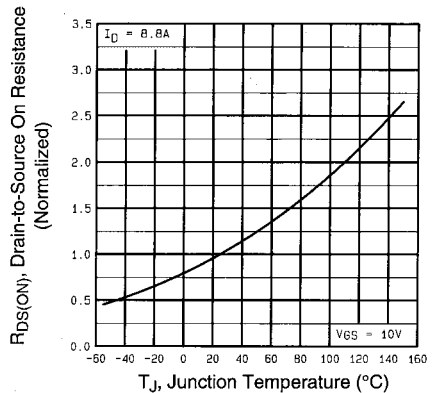

**Fig 4.** Normalized On-Resistance  
Vs. Temperature

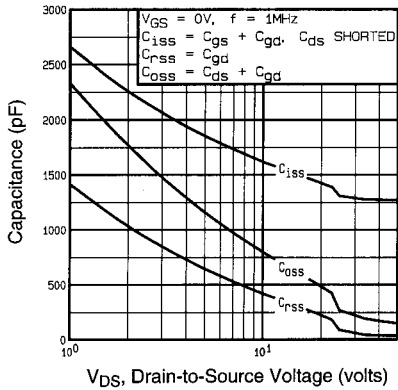

**Fig 5.** Typical Capacitance Vs. Drain-to-Source Voltage

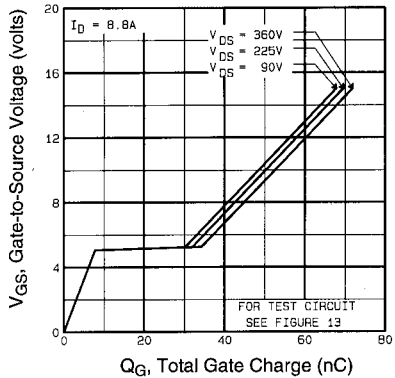

**Fig 6.** Typical Gate Charge Vs. Gate-to-Source Voltage

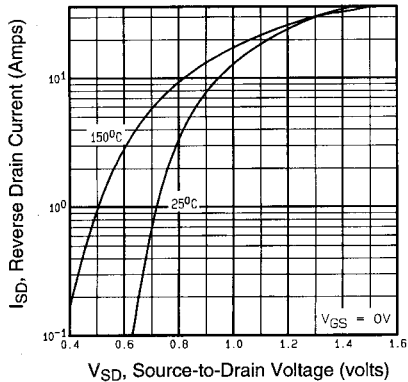

**Fig 7.** Typical Source-Drain Diode Forward Voltage

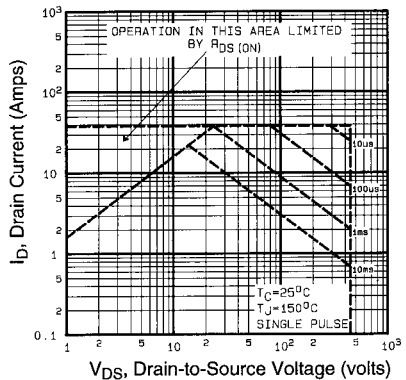

**Fig 8.** Maximum Safe Operating Area

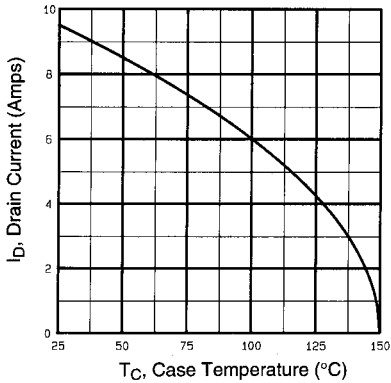

**Fig 9.** Maximum Drain Current Vs. Case Temperature

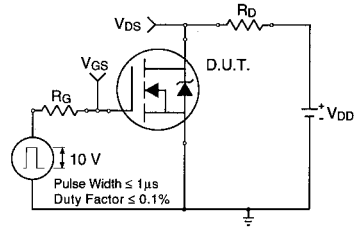

**Fig 10a.** Switching Time Test Circuit

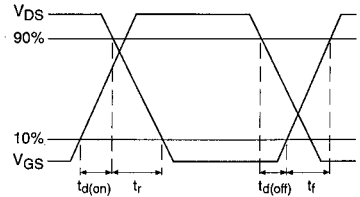

**Fig 10b.** Switching Time Waveforms

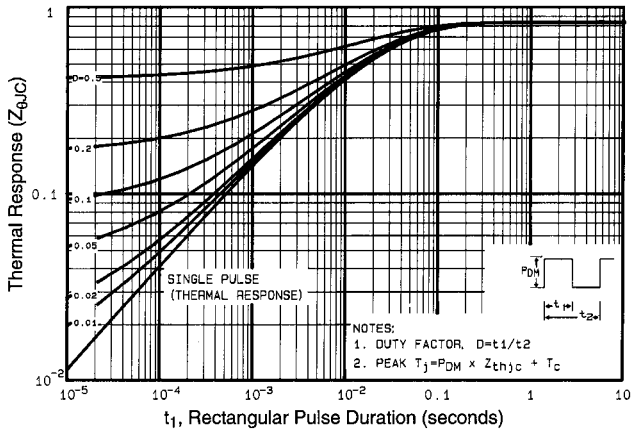

**Fig 11.** Maximum Effective Transient Thermal Impedance, Junction-to-Case

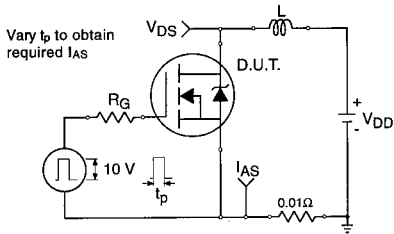

**Fig 12a.** Unclamped Inductive Test Circuit

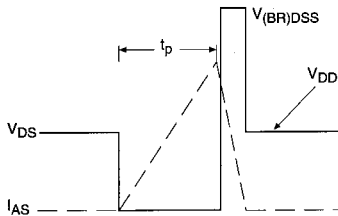

**Fig 12b.** Unclamped Inductive Waveforms

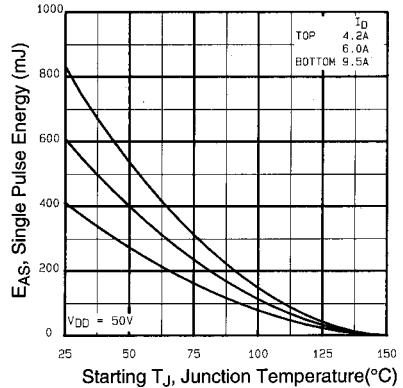

**Fig 12c.** Maximum Avalanche Energy Vs. Drain Current

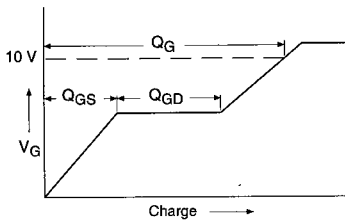

**Fig 13a.** Basic Gate Charge Waveform

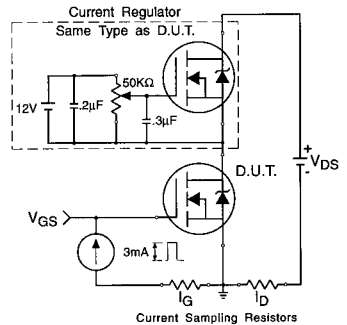
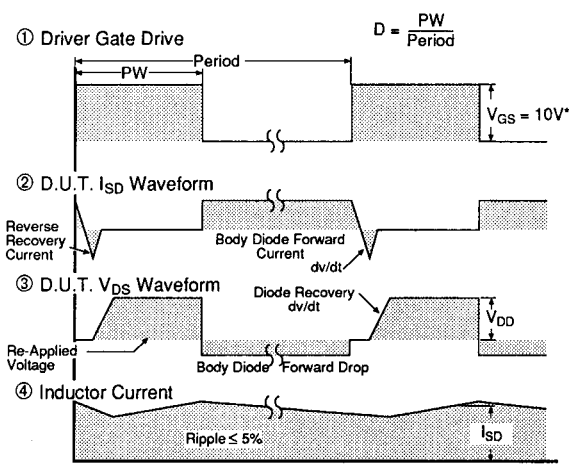
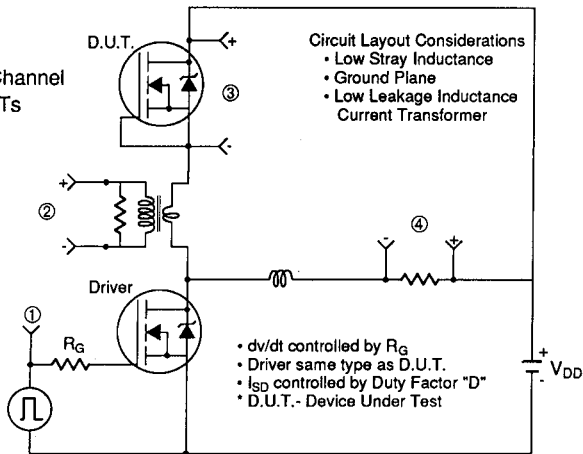

**Fig 13b.** Gate Charge Test Circuit

# Appendix A

## Peak Diode Recovery dv/dt Test Circuit

Fig 14. For N-Channel HEXFETs



\*  $V_{GS} = 5V$  for Logic Level Devices

## Package Outline

### TO-247AC Outline

Dimensions are shown in millimeters (inches)

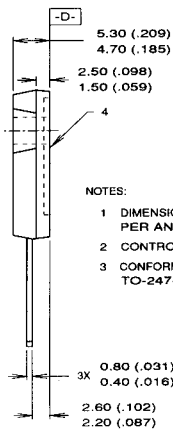
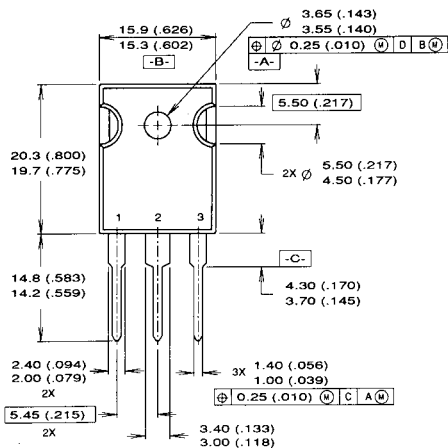

#### NOTES:

- DIMENSIONING & TOLERANCING PER ANSI Y14.5M, 1982.
- CONTROLLING DIMENSION: INCH.
- CONFORMS TO JEDEC OUTLINE TO-247-AC.

#### LEAD ASSIGNMENTS

- GATE
- DRAIN
- SOURCE
- DRAIN

## Part Marking Information

### TO-247AC

EXAMPLE: THIS IS AN IRFPE30 WITH ASSEMBLY LOT CODE 3A1Q

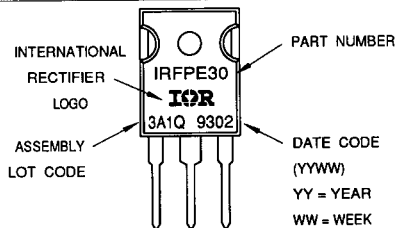

Printed on Signet recycled offset: made from 50% recycled waste paper, including 10% de-inked, post-consumer waste.



**International**  
**IR Rectifier**

WORLD HEADQUARTERS: 233 Kansas St., El Segundo, California 90245, Tel: (310) 322-3331, Twx: 4720403  
EUROPEAN HEADQUARTERS: Hurst Green, Oxted, Surrey RH8 9BB England, Tel: (0883) 713215, Twx: 95219

IR CANADA: 101 Bentley St., Markham, Ontario L3R 3L1, Tel: (416) 475-1897. IR GERMANY: Seaburgstrasse 157, D-6380 Bad Homburg, Tel: 6172-37056. IR ITALY: Via Liguria 49 10071 Borgaro, Torino, Tel: (011) 470 1484. IR FAR EAST: K&H Building, 30-4 Nishikibukuro 3-Chome, Toshima-ku, Tokyo 171 Japan, Tel: (03) 983 0641. IR SOUTHEAST ASIA: 180 Middle Road, HEX 10-01 Fortune Centre, Singapore 0716, Tel: (65) 336 3922.

Sales Offices, Agents and Distributors in Major Cities Throughout the World.