

FGA15N120ANTD

1200V NPT Trench IGBT

Features

- NPT Trench Technology, Positive temperature coefficient
- Low saturation voltage: $V_{CE(sat), typ} = 1.9V$
@ $I_C = 15A$ and $T_C = 25^\circ C$
- Low switching loss: $E_{off, typ} = 0.6mJ$
@ $I_C = 15A$ and $T_C = 25^\circ C$
- Extremely enhanced avalanche capability

Description

Using Fairchild's proprietary trench design and advanced NPT technology, the 1200V NPT IGBT offers superior conduction and switching performances, high avalanche ruggedness and easy parallel operation.

This device is well suited for the resonant or soft switching application such as induction heating, microwave oven, etc.

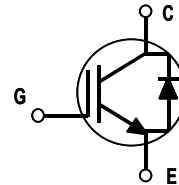
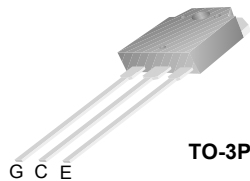

Absolute Maximum Ratings

Symbol	Description	FGA15N120ANTD	Units
V_{CES}	Collector-Emitter Voltage	1200	V
V_{GES}	Gate-Emitter Voltage	± 20	V
I_C	Collector Current	@ $T_C = 25^\circ C$	30
	Collector Current	@ $T_C = 100^\circ C$	15
I_{CM}	Pulsed Collector Current (Note 1)	45	A
I_F	Diode Continuous Forward Current	@ $T_C = 100^\circ C$	15
I_{FM}	Diode Maximum Forward Current	45	A
P_D	Maximum Power Dissipation	@ $T_C = 25^\circ C$	186
	Maximum Power Dissipation	@ $T_C = 100^\circ C$	74
T_J	Operating Junction Temperature	-55 to +150	$^\circ C$
T_{stg}	Storage Temperature Range	-55 to +150	$^\circ C$
T_L	Maximum Lead Temp. for soldering Purposes, 1/8" from case for 5 seconds	300	$^\circ C$

Thermal Characteristics

Symbol	Parameter	Typ.	Max.	Units
$R_{\theta JC}$	Thermal Resistance, Junction-to-Case for IGBT	--	0.67	$^\circ C/W$
$R_{\theta JC}$	Thermal Resistance, Junction-to-Case for Diode	--	2.88	$^\circ C/W$
$R_{\theta JA}$	Thermal Resistance, Junction-to-Ambient	--	40	$^\circ C/W$

Notes:

(1) Repetitive rating: Pulse width limited by max. junction temperature

Package Marking and Ordering Information

Device Marking	Device	Package	Reel Size	Tape Width	Quantity
FGA15N120ANTD	FGA15N120ANTD	TO-3P	--	--	30

Electrical Characteristics of the IGBT T_C = 25°C unless otherwise noted

Symbol	Parameter	Test Conditions	Min.	Typ.	Max.	Units
Off Characteristics						
I _{CES}	Collector Cut-Off Current	V _{CE} = V _{CES} , V _{GE} = 0V	--	--	3	mA
I _{GES}	G-E Leakage Current	V _{GE} = V _{GES} , V _{CE} = 0V	--	--	± 250	nA
On Characteristics						
V _{GE(th)}	G-E Threshold Voltage	I _C = 15mA, V _{CE} = V _{GE}	4.5	6.5	8.5	V
V _{CE(sat)}	Collector to Emitter Saturation Voltage	I _C = 15A, V _{GE} = 15V	--	1.9	2.4	V
		I _C = 15A, V _{GE} = 15V, T _C = 125°C	--	2.2	--	V
		I _C = 30A, V _{GE} = 15V	--	2.3	--	V
Dynamic Characteristics						
C _{ies}	Input Capacitance	V _{CE} = 30V, V _{GE} = 0V, f = 1MHz	--	2650	--	pF
C _{oes}	Output Capacitance		--	143	--	pF
C _{res}	Reverse Transfer Capacitance		--	96	--	pF
Switching Characteristics						
t _{d(on)}	Turn-On Delay Time	V _{CC} = 600 V, I _C = 15A, R _G = 10Ω, V _{GE} = 15V, Inductive Load, T _C = 25°C	--	15	--	ns
t _r	Rise Time		--	20	--	ns
t _{d(off)}	Turn-Off Delay Time		--	160	--	ns
t _f	Fall Time		--	100	180	ns
E _{on}	Turn-On Switching Loss		--	3	4.5	mJ
E _{off}	Turn-Off Switching Loss		--	0.6	0.9	mJ
E _{ts}	Total Switching Loss		--	3.6	5.4	mJ
t _{d(on)}	Turn-On Delay Time	V _{CC} = 600 V, I _C = 15A, R _G = 10Ω, V _{GE} = 15V, Inductive Load, T _C = 125°C	--	15	--	ns
t _r	Rise Time		--	20	--	ns
t _{d(off)}	Turn-Off Delay Time		--	170	--	ns
t _f	Fall Time		--	150	--	ns
E _{on}	Turn-On Switching Loss		--	3.2	4.8	mJ
E _{off}	Turn-Off Switching Loss		--	0.8	1.2	mJ
E _{ts}	Total Switching Loss		--	4.0	6.0	mJ
Q _g	Total Gate Charge	V _{CE} = 600 V, I _C = 15A, V _{GE} = 15V	--	120	180	nC
Q _{ge}	Gate-Emitter Charge		--	16	22	nC
Q _{gc}	Gate-Collector Charge		--	50	65	nC

Electrical Characteristics of DIODE $T_C = 25^\circ\text{C}$ unless otherwise noted

Symbol	Parameter	Test Conditions	Min.	Typ.	Max.	Units	
V_{FM}	Diode Forward Voltage	$I_F = 15\text{A}$	$T_C = 25^\circ\text{C}$	--	1.7	2.7	V
			$T_C = 125^\circ\text{C}$	--	1.8	--	
t_{rr}	Diode Reverse Recovery Time	$I_F = 15\text{A}$ $di/dt = 200\text{ A}/\mu\text{s}$	$T_C = 25^\circ\text{C}$	--	210	330	ns
			$T_C = 125^\circ\text{C}$	--	280	--	
I_{rr}	Diode Peak Reverse Recovery Current		$T_C = 25^\circ\text{C}$	--	27	40	A
			$T_C = 125^\circ\text{C}$	--	31	--	
Q_{rr}	Diode Reverse Recovery Charge		$T_C = 25^\circ\text{C}$	--	2835	6600	nC
			$T_C = 125^\circ\text{C}$	--	4340	--	

Typical Performance Characteristics

Figure 1. Typical Output Characteristics

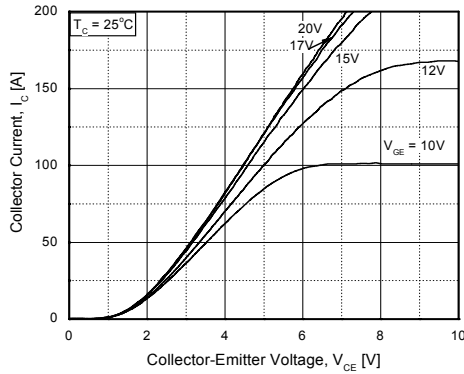

Figure 2. Typical Saturation Voltage Characteristics

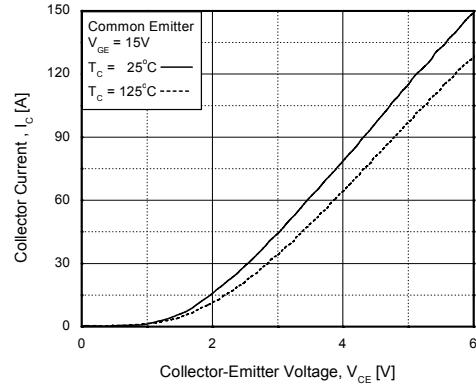

Figure 3. Saturation Voltage vs. Case Temperature at Variant Current Level

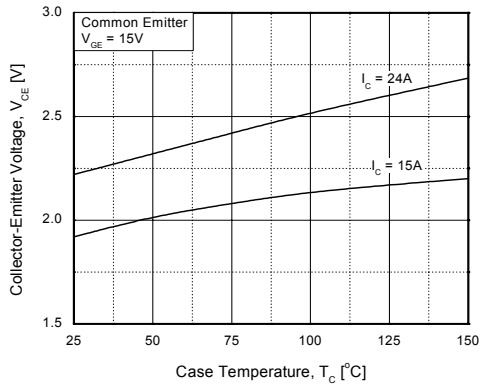

Figure 4. Saturation Voltage vs. V_GE

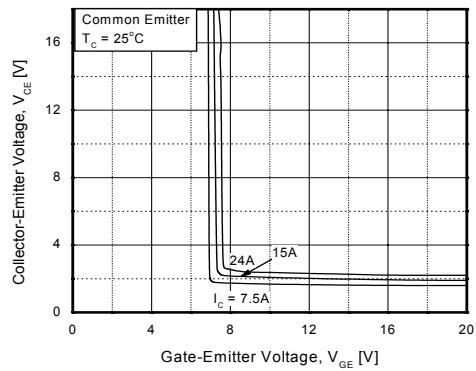

Figure 5. Saturation Voltage vs. V_GE

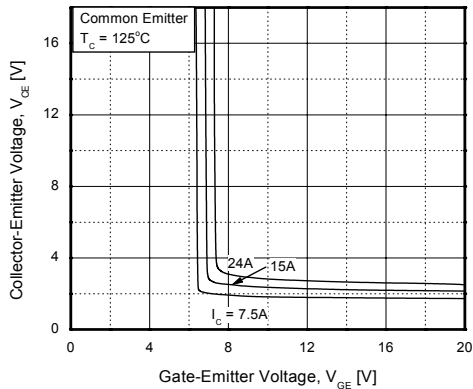
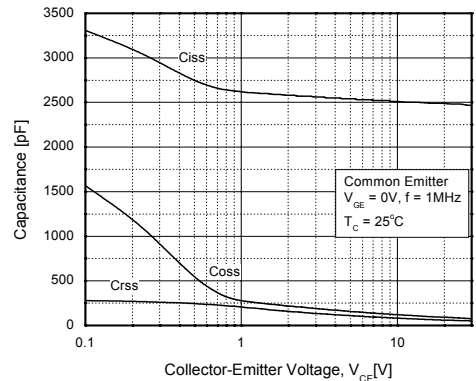

Figure 6. Capacitance Characteristics



Typical Performance Characteristics (Continued)

Figure 7. Turn-On Characteristics vs. Gate Resistance

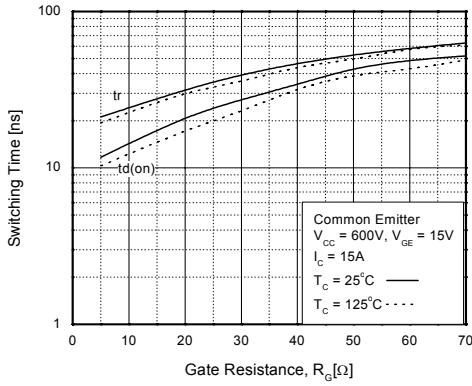

Figure 8. Turn-Off Characteristics vs. Gate Resistance

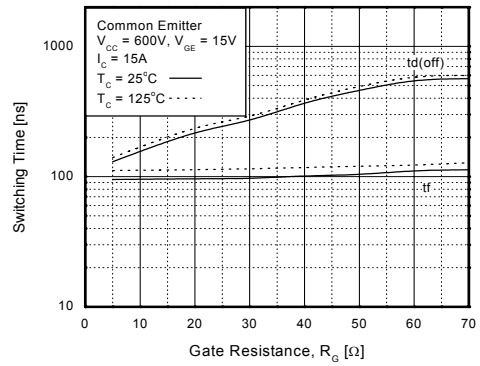

Figure 9. Switching Loss vs. Gate Resistance

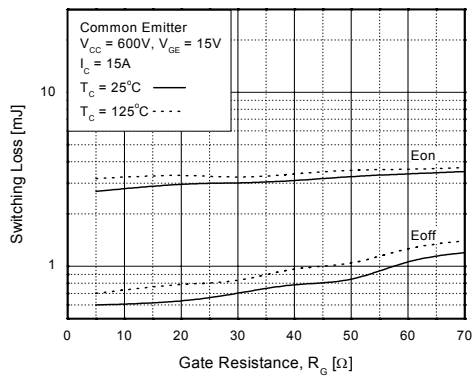

Figure 10. Turn-On Characteristics vs. Collector Current

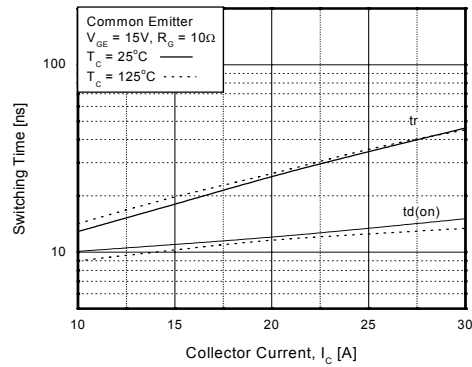

Figure 11. Turn-Off Characteristics vs. Collector Current

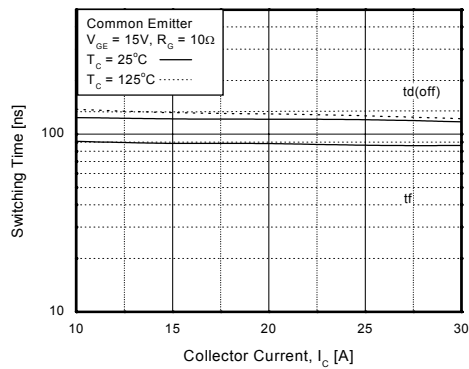
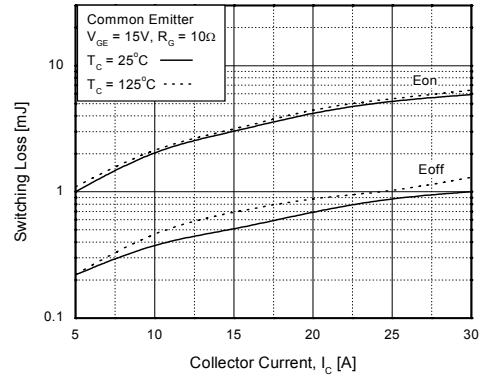

Figure 12. Switching Loss vs. Collector Current



Typical Performance Characteristics (Continued)

Figure 13. Gate Charge Characteristics

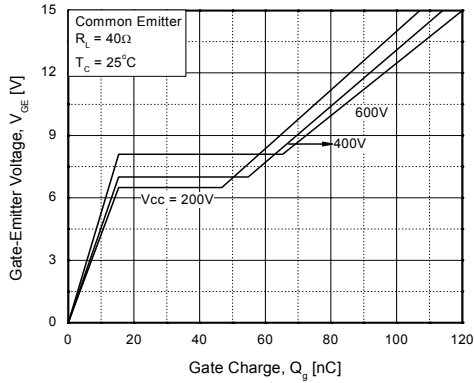

Figure 14. SOA Characteristics

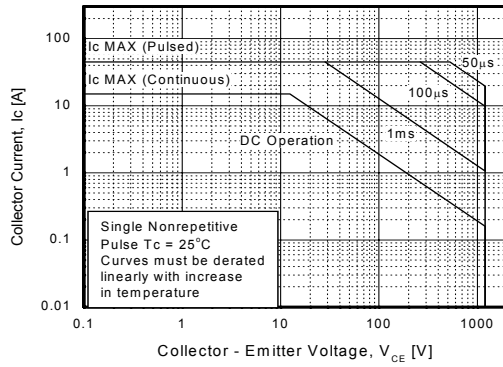

Figure 15. Turn-Off SOA

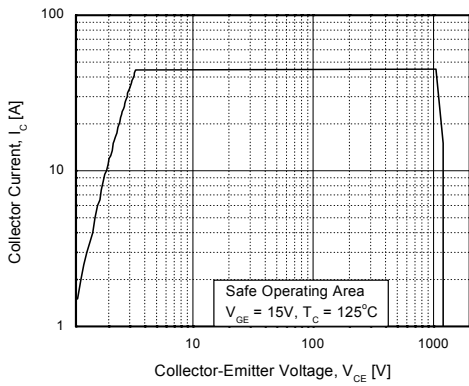
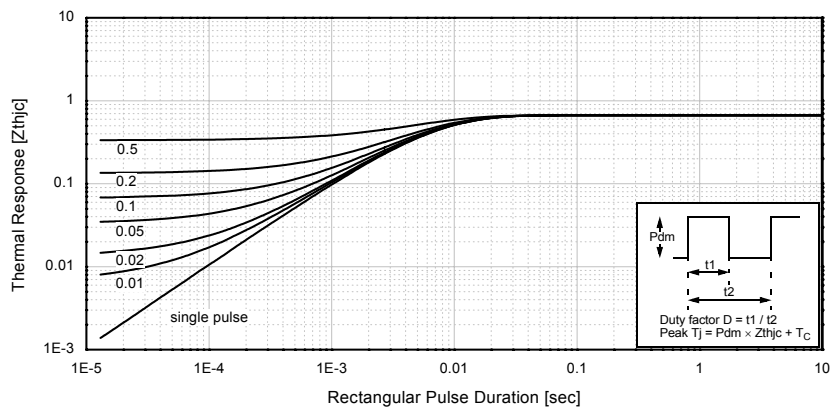

Figure 16. Transient Thermal Impedance of IGBT



Typical Performance Characteristics (Continued)

Figure 17. Forward Characteristics

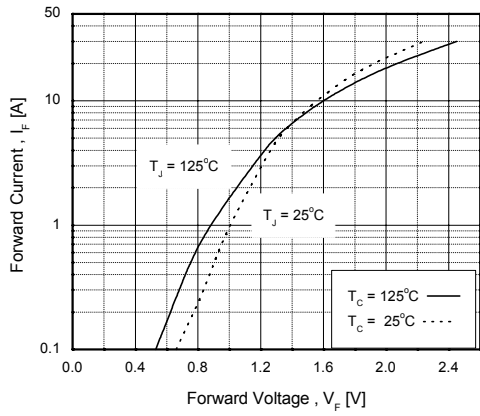

Figure 18. Reverse Recovery Current

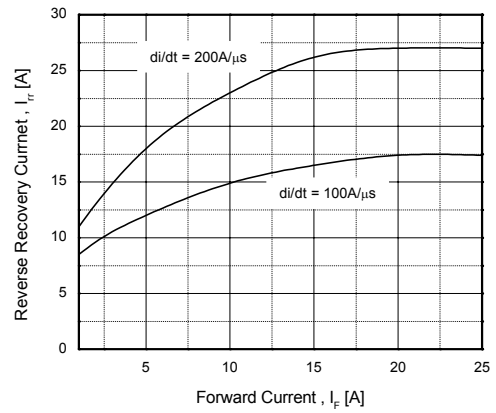

Figure 19. Stored Charge

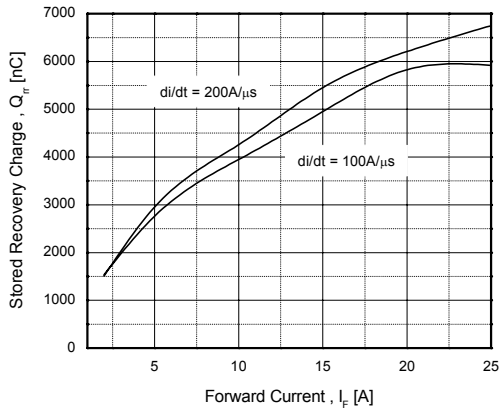
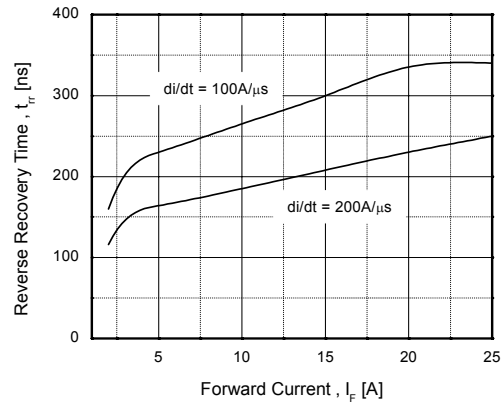
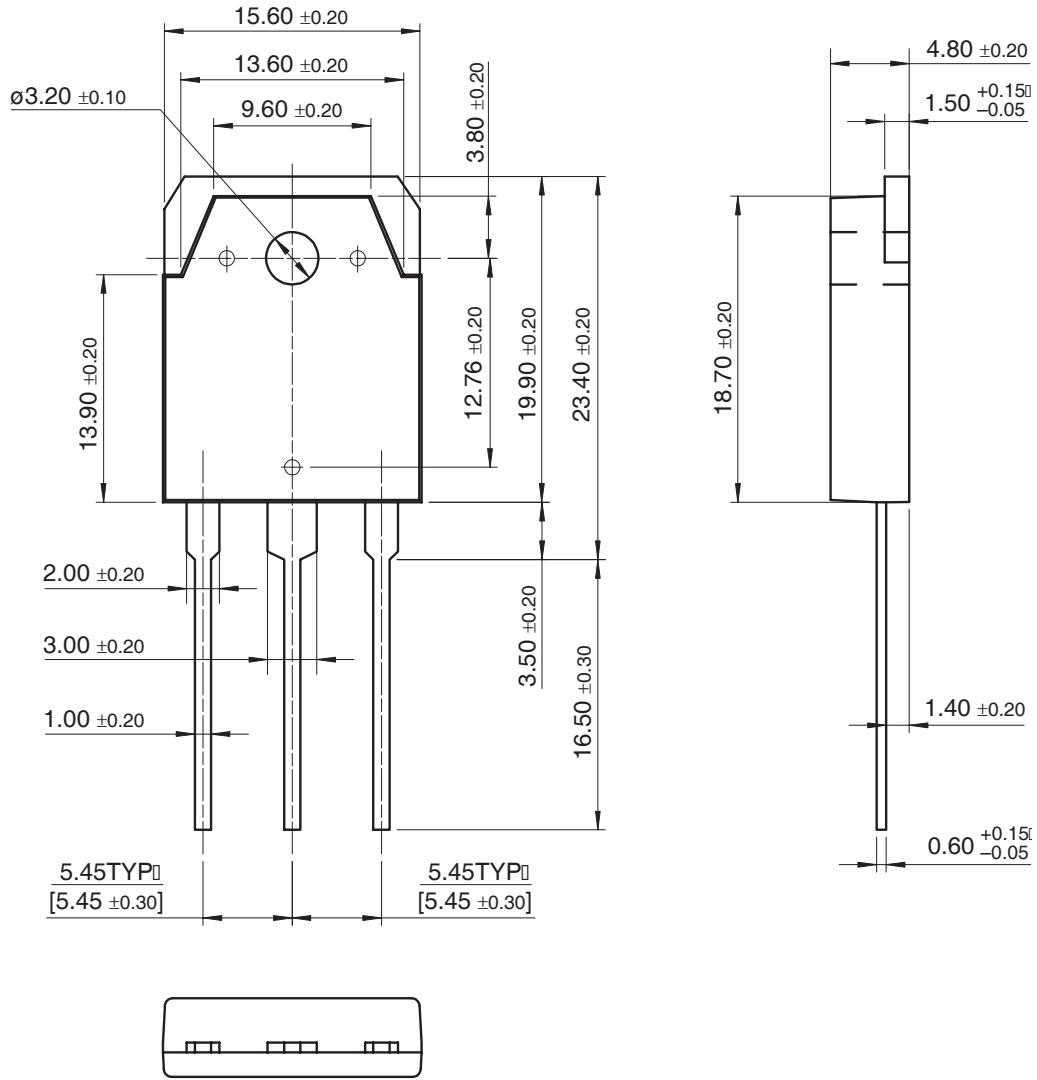

Figure 20. Reverse Recovery Time



Mechanical Dimensions

TO-3P



Dimensions in Millimeters

TRADEMARKS

The following are registered and unregistered trademarks Fairchild Semiconductor owns or is authorized to use and is not intended to be an exhaustive list of all such trademarks.

ACE [™]	FAST [®]	ISOPLANAR [™]	PowerEdge [™]	SuperFET [™]
ActiveArray [™]	FASTr [™]	LittleFET [™]	PowerSaver [™]	SuperSOT [™] -3
Bottomless [™]	FPS [™]	MICROCOUPLER [™]	PowerTrench [®]	SuperSOT [™] -6
Build it Now [™]	FRFET [™]	MicroFET [™]	QFET [®]	SuperSOT [™] -8
CoolFET [™]	GlobalOptoisolator [™]	MicroPak [™]	QS [™]	SyncFET [™]
CROSSVOLT [™]	GTO [™]	MICROWIRE [™]	QT Optoelectronics [™]	TCM [™]
DOME [™]	HiSeC [™]	MSX [™]	Quiet Series [™]	TinyLogic [®]
EcoSPARK [™]	I ² C [™]	MSXPro [™]	RapidConfigure [™]	TINYOPTO [™]
E ² CMOS [™]	i-Lo [™]	OCX [™]	RapidConnect [™]	TruTranslation [™]
EnSigna [™]	ImpliedDisconnect [™]	OCXPro [™]	μSerDes [™]	UHC [™]
FACT [™]	IntelliMAX [™]	OPTOLOGIC [®]	ScalarPump [™]	UniFET [™]
FACT Quiet Series [™]		OPTOPLANAR [™]	SILENT SWITCHER [®]	UltraFET [®]
Across the board. Around the world. [™]		PACMAN [™]	SMART START [™]	VCX [™]
The Power Franchise [®]		POPT [™]	SPM [™]	Wire [™]
Programmable Active Droop [™]		Power247 [™]	Stealth [™]	

DISCLAIMER

FAIRCHILD SEMICONDUCTOR RESERVES THE RIGHT TO MAKE CHANGES WITHOUT FURTHER NOTICE TO ANY PRODUCTS HEREIN TO IMPROVE RELIABILITY, FUNCTION OR DESIGN. FAIRCHILD DOES NOT ASSUME ANY LIABILITY ARISING OUT OF THE APPLICATION OR USE OF ANY PRODUCT OR CIRCUIT DESCRIBED HEREIN; NEITHER DOES IT CONVEY ANY LICENSE UNDER ITS PATENT RIGHTS, NOR THE RIGHTS OF OTHERS. THESE SPECIFICATIONS DO NOT EXPAND THE TERMS OF FAIRCHILD'S WORLDWIDE TERMS AND CONDITIONS, SPECIFICALLY THE WARRANTY THEREIN, WHICH COVERS THESE PRODUCTS.

LIFE SUPPORT POLICY

FAIRCHILD'S PRODUCTS ARE NOT AUTHORIZED FOR USE AS CRITICAL COMPONENTS IN LIFE SUPPORT DEVICES OR SYSTEMS WITHOUT THE EXPRESS WRITTEN APPROVAL OF FAIRCHILD SEMICONDUCTOR CORPORATION.

As used herein:

1. Life support devices or systems are devices or systems which, (a) are intended for surgical implant into the body, or (b) support or sustain life, or (c) whose failure to perform when properly used in accordance with instructions for use provided in the labeling, can be reasonably expected to result in significant injury to the user.
2. A critical component is any component of a life support device or system whose failure to perform can be reasonably expected to cause the failure of the life support device or system, or to affect its safety or effectiveness.

PRODUCT STATUS DEFINITIONS

Definition of Terms

Datasheet Identification	Product Status	Definition
Advance Information	Formative or In Design	This datasheet contains the design specifications for product development. Specifications may change in any manner without notice.
Preliminary	First Production	This datasheet contains preliminary data, and supplementary data will be published at a later date. Fairchild Semiconductor reserves the right to make changes at any time without notice in order to improve design.
No Identification Needed	Full Production	This datasheet contains final specifications. Fairchild Semiconductor reserves the right to make changes at any time without notice in order to improve design.
Obsolete	Not In Production	This datasheet contains specifications on a product that has been discontinued by Fairchild semiconductor. The datasheet is printed for reference information only.

Rev. 119