

**SANYO**

No.1520B

**LC7816**

CMOS IC

**2-Pole 4-Position Analog Function Switch**

The LC7816 is a 2-pole 4-position analog function switch with 2 built-in CMOS analog switches (LC4966 type). A soft touch of a button enables switchover of the input signal source of an audio amplifier.

**Use :**

Function switchover of amplifier, receiver, etc. (2 poles 4 positions)

**Features :**

1. Good distortion characterisitic because of built-in analog switches of LC4966 type : Distortion 0.01% max./  $V_i=1V_{rms}$ ,  $V_{DD}-V_{EE}=15$  to  $37V$ .
2. Capable of outputting audio muting control signal to minimize noise to be generated at the time of switchover.
3. Built-in controller for tape monitor switchover (using LC4966 together).
4. Built-in driver for LED which displays function mode, tape monitor mode.
5. Since control input can be operated from + supply alone when using dual supplies (+, -), interface with other circuits can be achieved easily.
6. Since audio muting control signal can be triggered independently from external pin (MUTEin), audio muting at the time of return from backup can be achieved easily.
7. Control input pin (RESET) to be used for turning OFF all analog switches.
8. Backup can be performed easily because of CMOS structure. (Backup voltage: 3V min.)
9. Operating voltage :  $\pm 18V$ /dual supplies.
10. Package : DIP-28S (Shrink type).

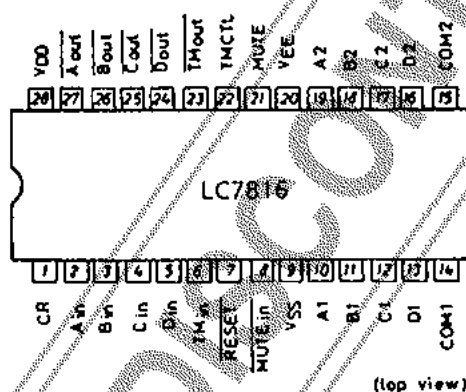
**Pin Assignment**

Case Outline 3063-D28SNIC  
(unit:mm)

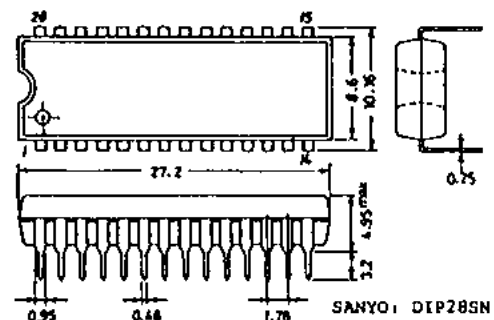

Specifications and information herein are subject to change without notice.

**SANYO Electric Co., Ltd. Semiconductor Overseas Marketing Div.**  
Natsume Bldg., 18-6, 2-chome, Yushima, Bunkyo-ku, TOKYO 113 JAPAN

7048YT/8266KI/6194KI, TS No.1520-1/7

Equivalent Circuit Block Diagram

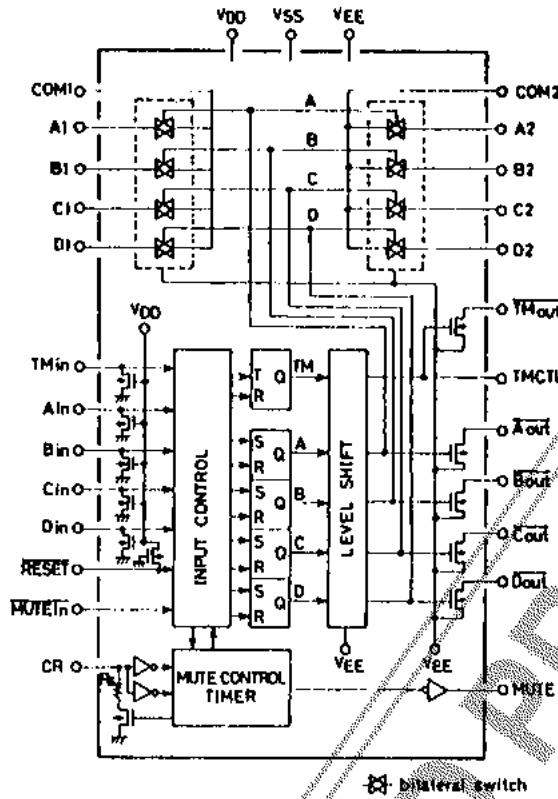

Sample Application Circuits

1. Without tape monitor function

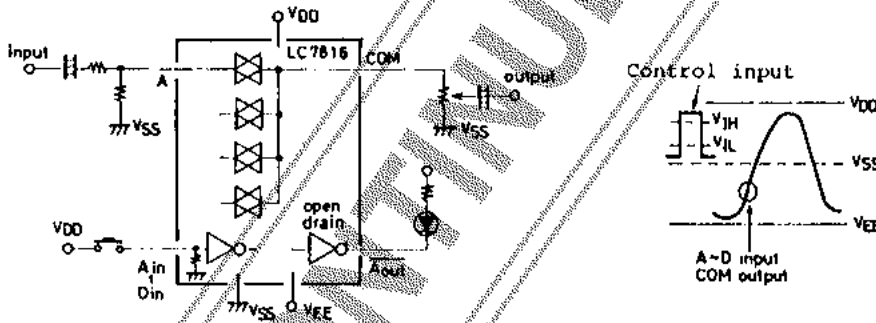

2. With tape monitor function

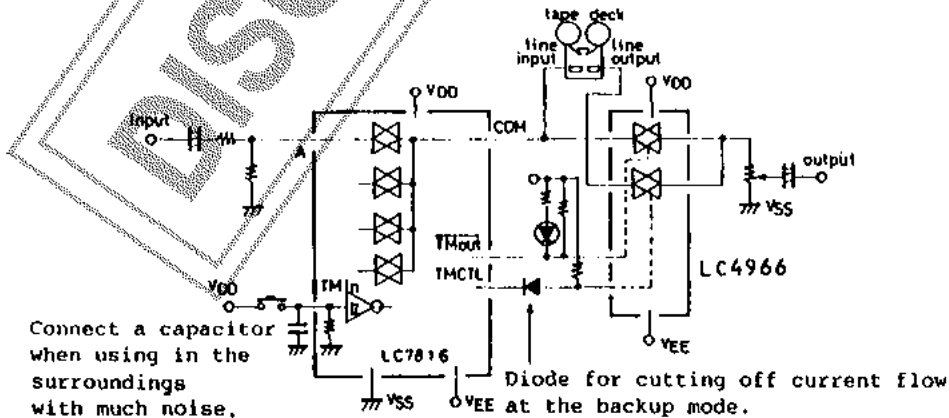

3. Backup

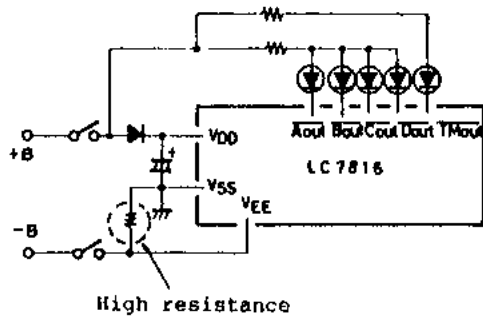

4. Muting

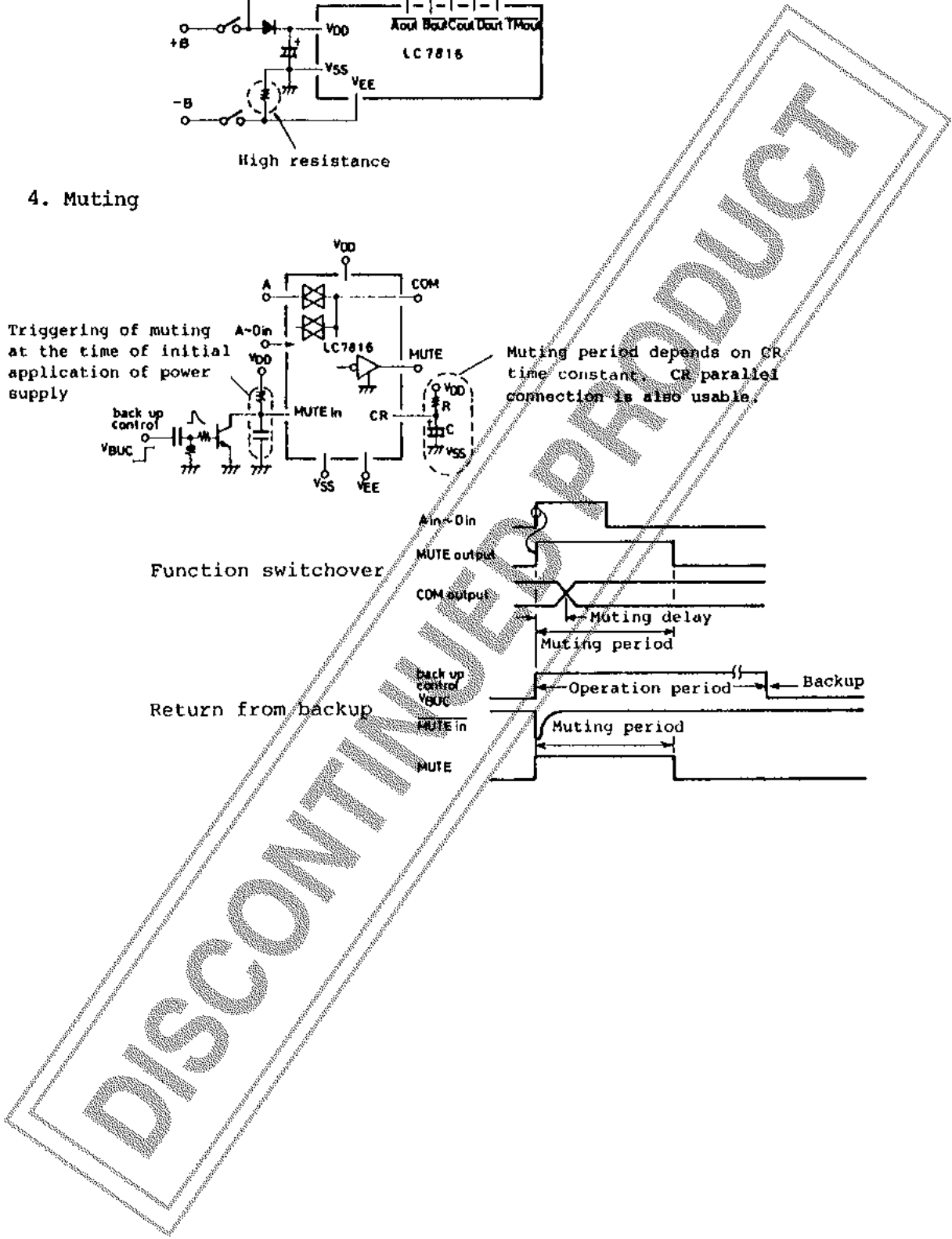
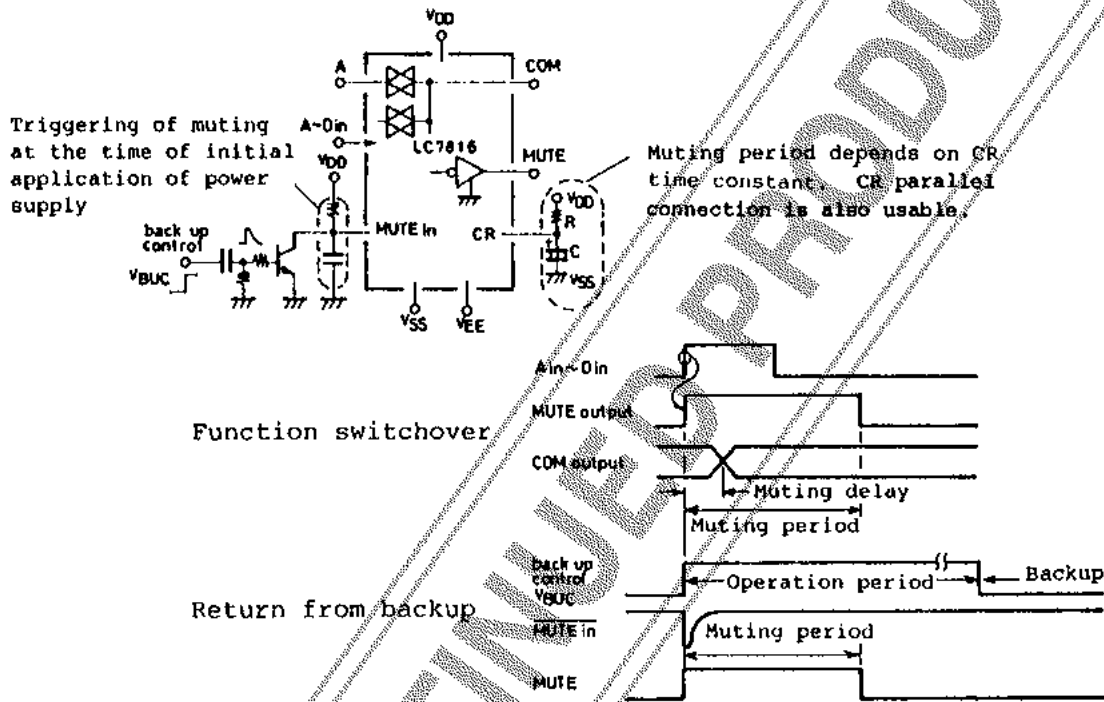

Pin Description

Pin Name	Pin No.	Type of Input/Output	Pin Functions																													
VDD VSS VEE	28 9 20		<ul style="list-style-type: none"> <li>Power supply pins</li> <li>Dual supplies (+-): VSS=GND, VEE=-1V</li> </ul>																													
Ain, Bin, Cin, Din	2, 3, 4, 5		<ul style="list-style-type: none"> <li>Input pins for turning ON individual analog switches</li> <li>Priority order of simultaneous push(Ain&gt;Bin&gt;Cin&gt;Din)</li> <li>Prevention of malfunction attributable to pulse noise (Pulse width is discriminated by muting delay time.)</li> </ul>																													
Aout Bout Cout Dout	27, 26, 25, 24		<ul style="list-style-type: none"> <li>Output of driver for LED which displays ON state corresponding to individual analog switches</li> <li>N channel open drain(Source is connected to VEE)</li> </ul>																													
A1, B1, C1, D1 A2, B2, C2, D2 COM1 COM2	10, 11, 12, 13 19, 18, 17, 16 14 15		<ul style="list-style-type: none"> <li>A to D: Audio signal input pins</li> <li>COM: Audio signal output pins</li> <li>Signal inputs (A to D)conduct according to signal inputs(Ain to Din) as follows</li> </ul> <table border="1" style="margin-left: auto; margin-right: auto;"> <thead> <tr> <th>COM output</th> <th>An</th> <th>Bn</th> <th>Cn</th> <th>Dn</th> </tr> </thead> <tbody> <tr> <td>Specified</td> <td>Ain</td> <td>1</td> <td>0</td> <td>0</td> <td>0</td> </tr> <tr> <td>input</td> <td>Bin</td> <td>*</td> <td>1</td> <td>0</td> <td>0</td> </tr> <tr> <td></td> <td>Cin</td> <td>*</td> <td>*</td> <td>1</td> <td>0</td> </tr> <tr> <td></td> <td>Din</td> <td>*</td> <td>*</td> <td>*</td> <td>1</td> </tr> </tbody> </table> <p style="text-align: right;">*: Don't care</p>	COM output	An	Bn	Cn	Dn	Specified	Ain	1	0	0	0	input	Bin	*	1	0	0		Cin	*	*	1	0		Din	*	*	*	1
COM output	An	Bn	Cn	Dn																												
Specified	Ain	1	0	0	0																											
input	Bin	*	1	0	0																											
	Cin	*	*	1	0																											
	Din	*	*	*	1																											
TMin	6		<ul style="list-style-type: none"> <li>Input pin for specifying tape monitor mode ON/OFF</li> <li>Rise of input signal is detected; monitor mode ON/OFF are inverted to monitor mode OFF/ON respectively.</li> </ul>																													
TMCTL	22		<ul style="list-style-type: none"> <li>Output pin for controlling external analog switch (LC4966) for tape monitor</li> <li>Source of N channel transistor of complementary buffer output is connected to VEE.</li> </ul>																													
TMout	23		<ul style="list-style-type: none"> <li>Output pin for driver for LED which displays tape monitor state as well as for control of external switch (LC4966) for tape monitor.</li> <li>TMout is opposite in polarity to TMCTL.</li> </ul>																													
MUTEin	8		<ul style="list-style-type: none"> <li>Input pin for forcing audio muting control signal (MUTE) to be triggered externally</li> <li>If fixed at 'L' level, MUTE output becomes 'H' level.</li> </ul>																													
MUTE	21		<ul style="list-style-type: none"> <li>Output pin for audio muting control signal</li> <li>Signal with pulse width to be determined by external constant at CR pin is output at the time of function switchover or MUTEin input.</li> </ul>																													
CR	1		<ul style="list-style-type: none"> <li>CR time constant pin for determining time interval of audio muting control signal</li> <li>Time lag(muting delay) between muting signal rise and analog switch switchover depends on C*Rs time constant at the time of transistor ON. CR parallel connection also usable.</li> </ul>																													
RESET	7		<ul style="list-style-type: none"> <li>Input pin for turning OFF all analog switches and resetting tape monitor flip-flop('L' level active)</li> </ul>																													

LC7816

Absolute Maximum Ratings at Ta=25±2°C

Parameter	Symbol	Conditions	unit
Maximum Supply Voltage	VDD max	VSS-0.3 to VEE+40	V
	VEE max	VDD-40 to VSS+0.3	V
Output Current	IOUT	Aout, Bout, Cout, Dout, TMout	30 mA
Output Voltage	VOUT	" "	VEE-0.3 to VDD+0.3 V
Voltage Difference at Analog Switch ON	ΔVon	Switch ON	0.5 V
Allowable Power Dissipation	Pd max	Ta≤85°C	350 mW
Operating Temperature	Topg		-40 to +85 °C
Storage Temperature	Tstg		-40 to +125 °C

Allowable Operating Conditions at Ta=-40 to +85°C

Parameter	Pin No.	Conditions	min	typ	max	unit
Supply Voltage	VDD1 VDD(28)	VEE≤VSS-4.5	VSS+4.5	VEE+37		V
	VEE VEE(20)	VDD≥VSS+4.5	VDD-37	VSS-4.5		V
	VDD2 VDD(28)	Backup VEE≤VSS	VSS+3	VSS+37		V
'H' Level Input Voltage	VIH1 Ain(2) to Din(5), RESET(7), MUTE in(8)		0.75VDD	VDD		V
	VIH2 TMin(6)		0.8VDD	VDD		V
'L' Level Input Voltage	VIL1 Ain(2) to Din(5), RESET(7), MUTE in(8)		VSS	0.25VDD		V
	VIL2 TMin(6)		VSS	0.2VDD		V
Analog Switch Input Voltage	VIN A1(10) to D1(13), A2(19) to D2(16)		VEE	VDD		V
External Capacitance C for Muting Timer	CR(1)				10	uF
External Resistance R for Muting Timer	CR(1)	VDD-VSS=4.5V	40		100	kohm
		14V>VDD-VSS≥9V	80		300	kohm
		18V>VDD-VSS≥14V	90		300	kohm
		37V>VDD-VSS≥18V	100		300	kohm
Input Receiving Pulse Width	TIN Ain(2) to Din(5) TMin(6)	VDD=9V, C=3.3uF, R=220kohms	120			ms

Electrical Characteristics at Ta=25±2°C, VSS=0V

Parameter	Pin NO.	Conditions	min	typ	max	unit
'H' Level Output Voltage	VOH1 TMCTL(22)	I <sub>OH</sub> =-0.1mA VDD=4.5 to 37V	0.8VDD		VDD	V
	VOH2 MUTE(21)	I <sub>OH</sub> =-0.4mA, VDD=4.5V	VDD-1.5		VDD	V
	"	, VDD=9V	VDD-0.5		VDD	V
'L' Level Output Voltage	VOL1 TMCTL(22)	I <sub>OL</sub> =0.1mA	VEE		0.2x (VDD-VEE)	V
	VOL2 MUTE(21)	I <sub>OL</sub> =0.4mA, VDD=4.5V	0		1.5	V
	"	, VDD≥9V	0		0.5	V
	VOL3 AOUT(27), DOUT(24)	I <sub>OL</sub> =7mA, VDD-VEE=4.5V	VEE		VEE+2	V
	TMOUT(23)	I <sub>OL</sub> =30mA, VDD-VEE=9V	VEE		VEE+4	V
Analog Switch ON Resistance	Ron	A1(10), B1(11)	I=1mA, VDD-VEE=4.5V		400	ohm
		C1(12), D1(13)	" , VDD-VEE=9V		120	ohm
		COM1(14)	" , VDD-VEE=18V		80	ohm
		A2(19), B2(18)	" , VDD-VEE=37V		70	ohm
		C2(17), D2(16), COM2(15)				

Continued on next page.

Continued from preceding page.

			min	typ	max	unit		
Input/Output OFF-Leak Current	IOFF1	AOUT(27) to DOUT(24)	Output transistor OFF			10	uA	
		TMOUT(23)	Vo=VEE+18V					
	IOFF2	CR(1)	Output transistor OFF			20	uA	
				Vo=VEE+37V				
Total Harmonic Distortion	THD1	A1(10) to D1(13), COM1(14), A2(19) to D2(16), COM2(15)	Analog switch OFF -10			10	uA	
			VIN=Vo=VEE to VEE+37V					
	THD2	" "	VIN=1Vrms, f=1kHz, VDD-VEE=15 to 37V, Refer to Fig.1.			0.01	%	
			VIN=0.1Vrms, f=1kHz, VDD-VEE=4.5V, Refer to Fig.1.			0.05	%	
Feedthrough (Switch OFF)	FTH	A1(10) to COM1(14) D1(13) to COM1(14) A2(19) to COM2(15) D2(16) to COM2(15)	VDD-VEE=37V, f=10kHz, VIN=0.77Vrms, Refer to Fig.2.			55	dB	
			RL=47kohms					
Crosstalk	CT	A1(10) to COM2(15) D1(13) to COM2(15) A2(19) to COM1(14) D2(16) to COM1(14)	VDD-VEE=37V, f=10kHz, VIN=0.77Vrms, Refer to Fig.3.			75	dB	
			RL=47kohms					
Muting Time	TM1	MUTE(21)	VDD=9V, Refer to Fig.4.			350 580 1000	ms	
			C=3.3uF±20%, R=220kohms±5%					
	TM2	MUTE(21)	VDD=9V, Refer to Fig.4.			450 580 800	ms	
			C=3.3uF±0%, R=220kohms±0%					
Switch Switchover Delay Time	TSWD	Ain(2) to Din(5) TMin(6)	VDD=9V, Refer to Fig.5.			30 50 120	ms	
Supply Current	IDDI	VDD(28)	Operating, Refer to Fig.6.			1000	uA	
Input Floating Voltage	VIF(1)	Ain(2) to Din(5) TMin(6)	VDD=4.5 to 37V			VSS	0.75	V
		VIF(2) RESET(7)	VDD=4.5 to 37V			VDD-0.75	VDD	V

Fig. 1 Total harmonic distortion

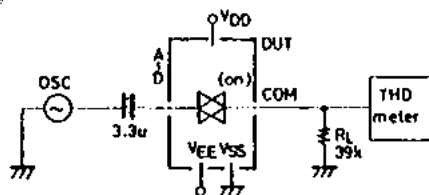
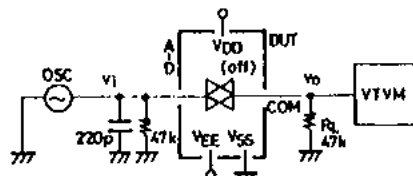

Fig. 2 Feedthrough



$$FTH = 20 \log \frac{V_o}{V_i} \text{ (dB)}$$

Vi=770mVrms  
VDD-VEE=37V

Fig. 3 Crosstalk

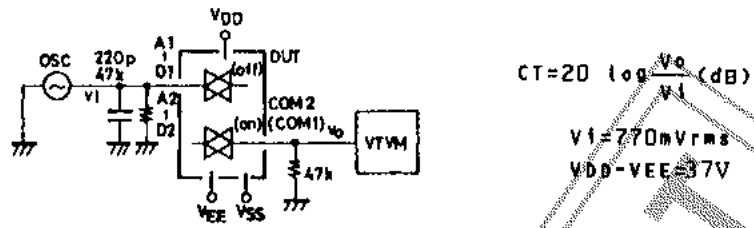

Fig. 4 Muting period

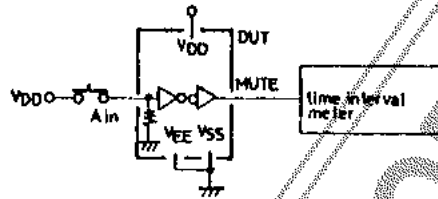

Fig. 5 Switch switchover delay time

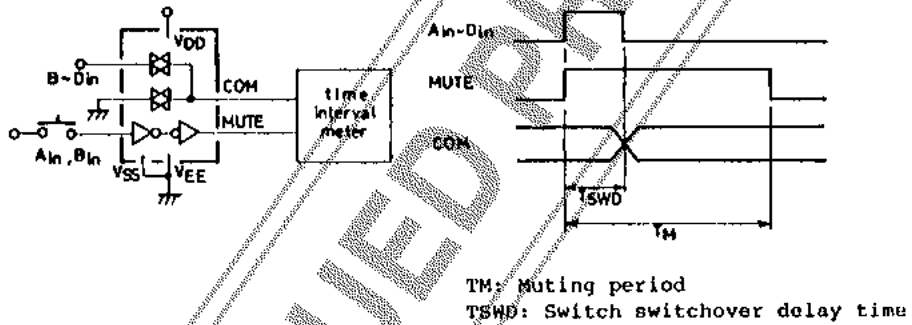
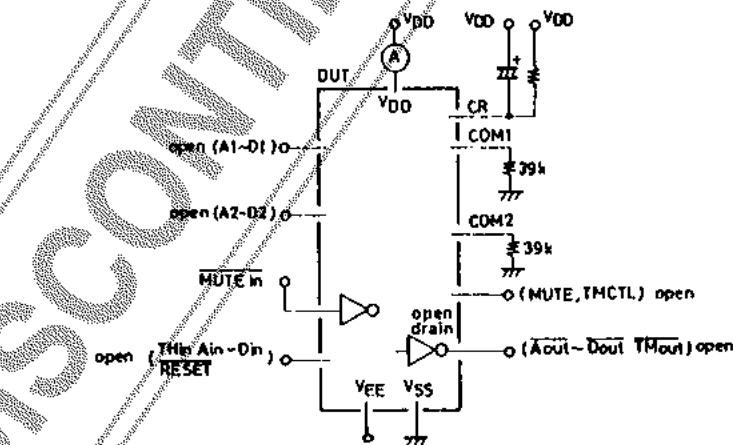

Fig. 6 Supply current



The application circuit diagrams and circuit constants herein are included as an example and provide no guarantee for designing equipment to be mass-produced. The information herein is believed to be accurate and reliable. However, no responsibility is assumed by SANYO for its use, nor for any infringements of patents or other rights of third parties which may result from its use.