

SANYO**LC72707E****FM Multiplex Receiver IC Supporting
All Worldwide Standards****Overview**

The LC72707E is a data demodulation IC for receiving FM multiplex broadcasts for mobile receivers in the DARC format. In conjunction with a bandpass filter IC (either the LV3400M or the LV3403M), the LC72707E can form a compact yet high-functionality FM multiplex reception system. This IC provides built-in DRIS system data processing decoder for Digital DJ CO.,LTD. Since supporting all the FM multiplex frame structures (methods A, A', B, and C) in the ITU-R recommendations, this IC is optimal for use in radios for FM multiplex system. Note that a contract with Digital Incorporated is required to evaluate this IC and to produce end products that support DRIS.

Applications

- Receivers for DARC format mobile receiver FM multiplex broadcasts
- FM multiplex receiver for the worldwide DRIS system of Digital DJ Incorporated.

Functions

- MSK delay detection circuit based on a 1T delay
- Error correction function based on a 2T delay (in the MSK detector stage)
- Digital PLL based clock regeneration circuit
- Shift-register type 1T and 2T delay circuits
- Block and frame synchronization detection circuit
- Serial control data transfer based support for the A, B, and C FM multiplex frame structures
- Function for setting the number of allowable BIC errors, the number of synchronization protection
- Error correction using (272, 190) codes
- Layer 4 CRC code checking circuit
- On-chip frame memory and memory control circuit for vertical correction

- 7.2-MHz crystal oscillator circuit
- Conforms to the DRIS format of Digital DJ Incorporated

Package Dimensions

unit: mm

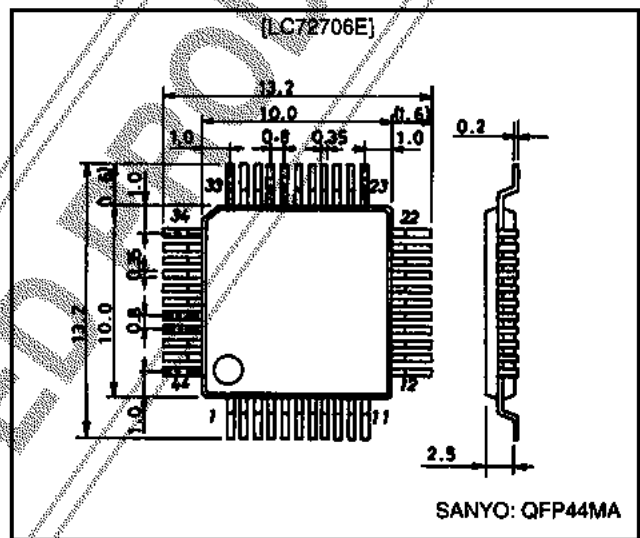
3148-QFP44MA

- CCB is a trademark of SANYO ELECTRIC CO., LTD.
- CCB is SANYO's original bus format and all the bus addresses are controlled by SANYO.
- DRIS is an abbreviation of Digital DJ Radio Information Services.
- DRIS is an FM multiplex broadcasts mobil receiving system which supports not only one-to-multiplex transmission but one-to-one information transmission.

SANYO Electric Co.,Ltd. Semiconductor Business Headquarters

TOKYO OFFICE Tokyo Bldg., 1-10, 1 Chome, Ueno, Taito-ku, TOKYO, 110-8534 JAPAN

Specifications

Absolute Maximum Ratings at $T_a = 25^\circ\text{C}$, $V_{SS} = 0\text{ V}$

Parameter	Symbol	Conditions	Ratings	Unit
Maximum supply voltage	$V_{DD\text{ max}}$		-0.3 to +7.0	V
Input voltage	V_{IN1}	CE, CL, DI, RST, STNBY	-0.3 to +7.0	V
	V_{IN2}	Pins other than V_{IN1}	-0.3 to $V_{DD} + 0.3$	V
Output voltage	V_{OUT1}	DO	-0.3 to +7.0	V
	V_{OUT2}	Pins other than V_{OUT1}	-0.3 to $V_{DD} + 0.3$	V
Output current	I_{OUT}	BLOCK, FLOCK, DO	0 to 4.0	mA
Allowable power dissipation	$P_d\text{ max}$	$T_a \leq 85^\circ\text{C}$	400	mW
Operating temperature	T_{opr}		-40 to +85	$^\circ\text{C}$
Storage temperature	T_{stg}		-55 to +125	$^\circ\text{C}$

Allowable Operating Ranges at $T_a = -40$ to 85°C , $V_{SS} = 0\text{ V}$

Parameter	Symbol	Conditions	Ratings			Unit
			min	typ	max	
Supply voltage	V_{DD}		2.7		5.5	V
Input high-level voltage	V_{IH1}	CL, CE, DI, RST, STNBY	$0.7 V_{DD}$		5.5	V
	V_{IH2}	MSK	$0.7 V_{DD}$		V_{DD}	V
Input low-level voltage	V_{IL1}	Applies to the same pins as V_{IH1}	V_{SS}		$0.3 V_{DD}$	V
	V_{IL2}	Applies to the same pins as V_{IH2}	V_{SS}		$0.3 V_{DD}$	V
Oscillator frequency	F_{OSC}	This IC operates at frequencies within a ± 250 ppm precision.		7.2		MHz
Input sensitivity	V_{XI}	With a capacitance-coupled sine wave input to X_{IN} , $V_{DD} = +4.5\text{ V to }5.5\text{ V}$	400		1500	mVrms
	V_{XI}	With a capacitance-coupled sine wave input to X_{IN} , $V_{DD} = +2.7\text{ V to }3.6\text{ V}$	400		900	mVrms
[Serial I/O*]						
Clock low-level time	t_{CL}	CL	0.7			μs
Clock high-level time	t_{CH}	CL	0.7			μs
Data setup time	t_{SU}	CL, DI	0.7			μs
Data hold time	t_{HD}	CL, DI	0.7			μs
CE wait time	t_{EW}	CL, CE	0.7			μs
CE setup time	t_{ES}	CL, CE	0.7			μs
CE hold time	t_{EH}	CL, CE	0.7			μs
Data latch change time	t_{LCH}	CE			0.7	μs
Data output time	t_{DO}	DO, CL	277		555	ns
Layer 4 CRC change time	t_{CRC}	CRC, CL			0.7	μs

Note *: See the serial data timing chart.

Electrical Characteristics (1) at $V_{DD} = +4.5$ to $+5.5\text{ V}$, in the allowable operating ranges

Parameter	Symbol	Conditions	Ratings			Unit
			min	typ	max	
Output high-level voltage	V_{OH1}	$I_O = 1\text{ mA}$, FLICK	$V_{DD} - 1.0$			V
	V_{OH2}	$I_O = 2\text{ mA}$, BLOCK, FLOCK, INT, CLK16, DATA	$V_{DD} - 0.4$			V
Output low-level voltage	V_{OL1}	$I_O = 1\text{ mA}$, applies to the same pins as V_{OH1}			1.0	V
	V_{OL2}	$I_O = 2\text{ mA}$, applies to the same pins as V_{OH2}			0.4	V
	V_{OL3}	$I_O = 2\text{ mA}$, DO			0.4	V
Input high-level current	I_{IH1}	$V_{IN} = 5.5\text{ V}$, CE, CL, DI, RST, STNBY			1.0	μA
	I_{IH2}	$V_{IN} = V_{DD}$, input pins other than I_{IH1}			1.0	μA
Input low-level current	I_{IL}	$V_{IN} = V_{SS}$, MSK, CL, CE, DI, RST, STNBY, TP0 to TP6, TPC1 to 2, TOSEL1 to 2, TEST			-1	μA
Output off leakage current	I_{OFF}	$V_O = V_{DD}$, DO			5	μA
Hysteresis voltage	V_{HIS}	MSK, CL, CE, DI, RST, STNBY		$0.1 V_{DD}$		V
Internal feedback resistor	R_I	X_{IN} , X_{OUT}		1.0		M Ω
Current drain	I_{DD}			18	25	mA

LC72707E

Electrical Characteristics (2) at $V_{DD} = +2.7$ to $+3.6$ V, in the allowable operating ranges

Parameter	Symbol	Conditions	Ratings			Unit
			min	typ	max	
Output high-level voltage	V_{OH1}	$I_O = 0.5$ mA, FLICK	$V_{DD} - 1.0$			V
	V_{OH2}	$I_O = 1$ mA, BLOCK, FLOCK, INT, CLK16, DATA	$V_{DD} - 0.4$			V
Output low-level voltage	V_{OL1}	$I_O = 0.5$ mA, applies to the same pins as V_{OH1}			1.0	V
	V_{OL2}	$I_O = 1$ mA, applies to the same pins as V_{OH2}			0.4	V
	V_{OL3}	$I_O = 1$ mA, DO			0.4	V
Input high-level current	I_{IH1}	$V_{IN} = 5.5$ V, CE, CL, DI, RST, STNBY			1.0	μ A
	I_{IH2}	$V_{IN} = V_{DD}$, Input pins other than I_{IH1}			1.0	μ A
Input low-level current	I_{IL}	$V_{IN} = V_{SS}$, MSK, CL, CE, DI, RST, STNBY, TP0 to TP8, TPC1 to 2, TOSEL1 to 2, TEST			-1	μ A
Output off leakage current	I_{OFF}	$V_O = V_{DD}$, DO			1	μ A
Hysteresis voltage	V_{HIS}	MSK, CL, CE, DI, RST, STNBY		$0.1 V_{DD}$		V
Internal feedback resistor	R_f	XIN, XOUT		25		$M\Omega$
Current drain	I_{DD}			8	12	mA

Block Diagram

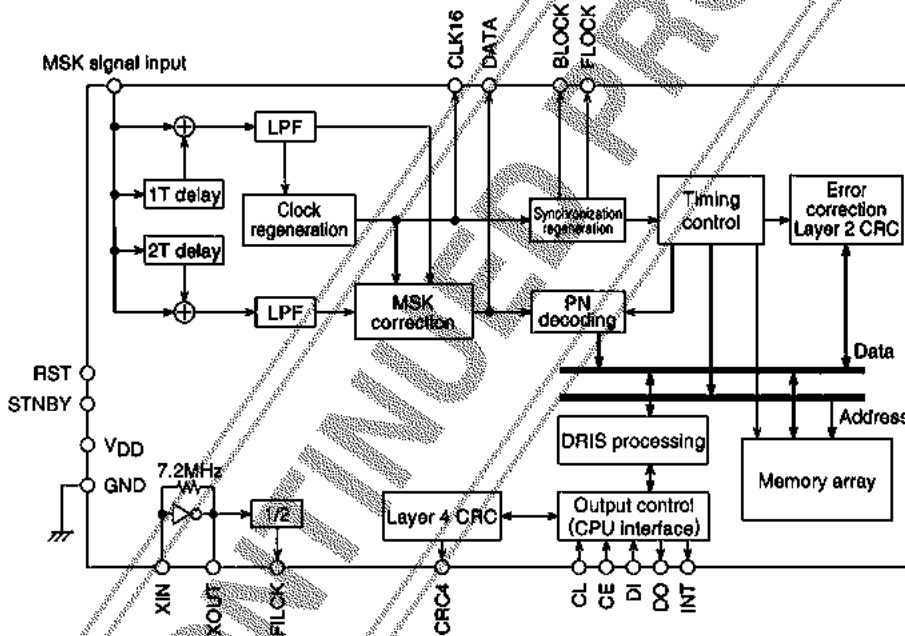

A08950

Pin Assignment

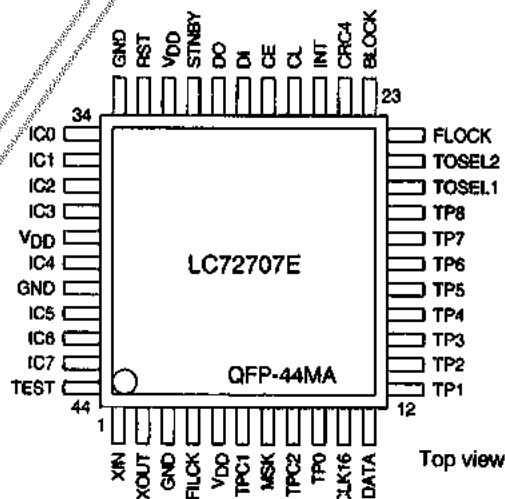

A08951

LC72707E

Pin Functions

Pin No.	Pin Name	Function	I/O	Circuit type
7	MSK	76-kHz MSK signal input (from the LV3400M/03M)	Input	
26	CL	CCB serial interface Clock input		
27	CE	Data control input		
28	DI	Data input		
32	RST	System reset input (active low)	Input	
30	STNBY	Standby mode (active high)		
44	TEST	Test (Must be connected to ground during normal operation.)		
9	TP0	Must be connected to either V_{DD} or V_{SS} .		
12	TP1			
13	TP2			
14	TP3			
15	TP4			
16	TP5			
17	TP6			
18	TP7			
19	TP8			
6	TPC1			
8	TPC2			
20	TOSEL1	Reference clock output for the LV3400M/03M	Output	
21	TOSEL2			
4	FLICK			
10	CLK16			
11	DATA	Demodulated data monitor	Output	
23	BLOCK	Outputs a high level during block synchronization.		
22	FLOCK	Outputs a high level during frame synchronization.		
24	CRC4	Layer 4 CRCC check result output		
25	INT	External CPU interrupt signal		
34	IC0	Internal connections. These pins must be left open.	Output	
35	IC1			
36	IC2			
37	IC3			
39	IC4			
41	IC5			
42	IC6			
43	IC7			
29	DO	Data output used by the CCB serial interface	Output	
1	XIN	System clock generation crystal oscillator element connections	Input Output	
2	XOUT			
5, 31, 38	V_{DD}	Power supply (+2.7 to 5.5 V)	—	
3, 33, 40	V_{SS}	Ground	—	

Data I/O Techniques

• CCB Technique

Sanyo audio ICs input and output data using the Sanyo CCB (computer control bus) standard, which is a serial bus format. This IC uses an 8-bit address CCB and uses the following addresses.

I/O mode	Address								Function
	B0	B1	B2	B3	A0	A1	A2	A3	
Input	0	1	0	1	1	1	1	1	16-bit control data input
Output	1	1	0	1	1	1	1	1	Data output for the input clock (CL)
Input	0	0	1	1	1	1	1	1	Data input (In 8-bit units) for the layer 4,CRC check circuit

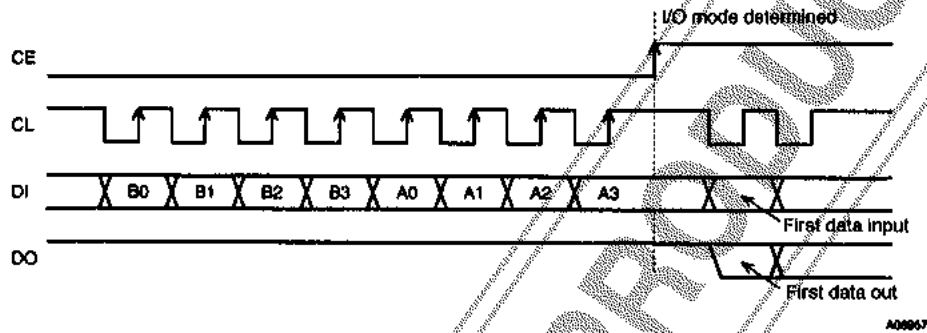

Data Input Timing

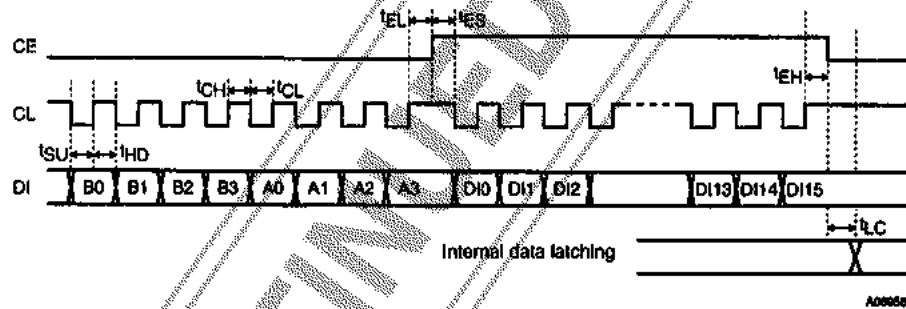

Data Output Timing

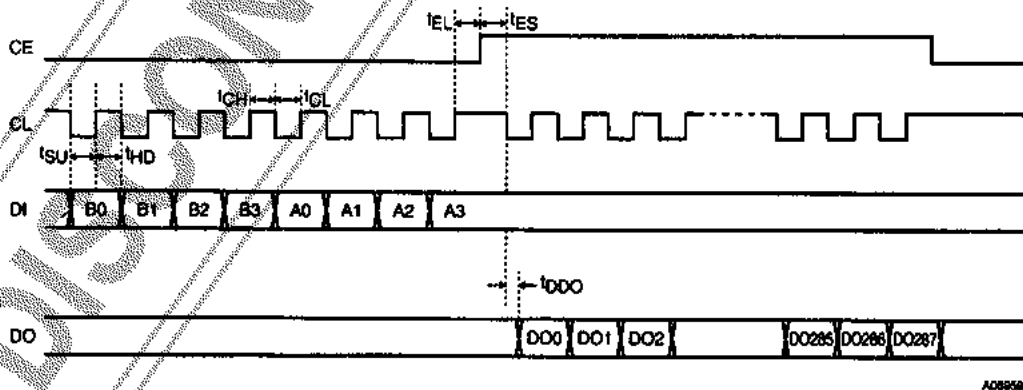

Note: The DO pin is normally left open.

Since the DO pin is an n-channel open drain pin, the time required for the data to change from the low level to the high level depends on the value of the pull-up resistor.

Layer 4 CRC Data Input Timing

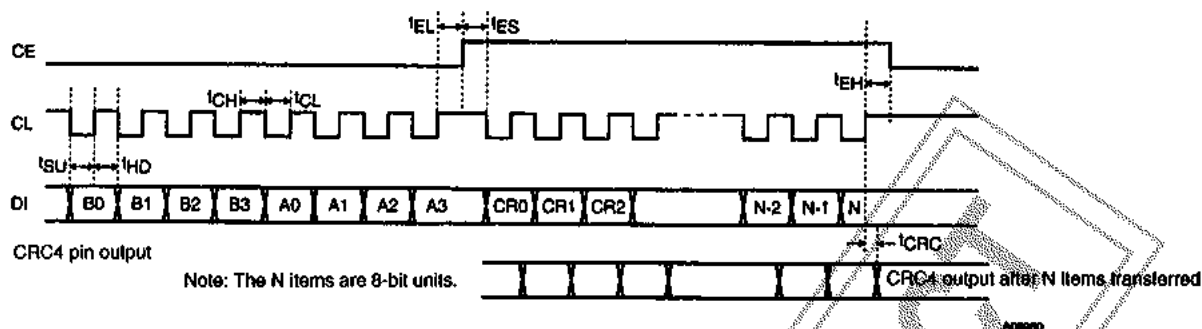

Serial Control Data Input Settings

The input data consists of 16 bits (DI0 to DI15). The upper 8 bits (DI8 to DI15) are the control address and the lower 8 bits (DI0 to DI7) are the input data. Bits DI12 to DI15 are ignored.

Register	Address				Data		Default setting
	DI11	DI10	DI9	DI8	Upper 4 bits	Lower 4 bits	
Number of allowable BIC errors	0	0	0	0	Upper 4 bits	Allowed error bits backward	2
					Lower 4 bits	Allowed error bits forward	
Number of block error protection states	0	0	0	1	Upper 4 bits	Block backward protection	1
					Lower 4 bits	Block forward protection	
Number of frame error protection states	0	0	1	0	Upper 4 bits	Frame backward protection	1
					Lower 4 bits	Frame forward protection	
Control register	0	0	1	1	See the control register description on page 8.		

• **Number of Allowed BIC Errors**

This IC's synchronization circuit operates by recognizing a 16-bit BIC code. The number of allowed errors is the number of allowed error bits in the 16 bits used for BIC recognition. This data item allows the forward protection mode (used when synchronized) and the backward protection mode (used when not synchronized) values to be set independently. The default value is to allow up to 2 error bits in both the forward and backward directions. We recommend setting the backward protection mode number of allowable BIC errors to 1 or 0 if the block synchronization recognition output (the BLOCK pin, pin 23) is used to recognize the presence or absence of FM multiplex data.

• **Block Synchronization Error Protection Count**

The synchronization protection count can be set independently in the forward and backward directions. The protection count conditions are as follows.

— **Backward protection (unsynchronized, BLOCK = low)**

When the timing of the IC's internal synchronization free-running counter matches that of the received BIC, the protection count is incremented by 1. Similarly, if the IC internal counter and the received BIC do not match, the counter is cleared to 0. The count timing is the timing of the IC internal counter.

— **Forward protection (synchronized, BLOCK = high)**

Operation is the opposite of the backward case, namely, the protection count is incremented when the timing of the IC's internal synchronization free-running counter does not match that of the received BIC, and the protection count is cleared to zero when the timing matches.

Figure 1 shows the protection counter when both the forward and backward protection counts are set to 3. This IC defines the protection counter value to be 1 at the point where a match or a mismatch occurs between the IC internal timing and the received BIC timing. For example, a backward protection count of 2 corresponds to the case where the IC internal timing and the received BIC timing match two times consecutively. To set the protection data to new values, applications must send data in which 1 has been subtracted from the desired values, e.g. to set up protection counts of 3 as shown in figure 1, applications must send the value 22H. Similarly, if the value set is 00, due to the definition, the protection counts for both the forward and backward directions will be set to 1. However, from an operation standpoint, this corresponds to operation equivalent to there being no protection circuit. The default values are a forward protection count of 8 and a backward protection count of 2. We recommend resetting the block synchronization backward protection count to a value more strict than the default,

e.g. to a value of 3 or more as opposed to the default of 2, if the block synchronization recognition output (the BLOCK pin, pin 23) is used to recognize the presence or absence of FM multiplex data.

• **Frame Synchronization Error Protection Count**

This IC detects the four unique BIC inflection points that exist in a single frame, and increments or decrements the protection counter depending on whether or not the IC internal frame synchronization counter matches. The data values are set in the same way as those for the block synchronization protection count are set, namely data in which 1 has been subtracted from the desired protection count must be transferred. The frame synchronization default values are 8 for forward protection and 2 for backward protection.

• **Control Registers**

These registers are used to set the IC operating mode. These are described later.

• **Notes**

- The address bits DI12 to DI15 are ignored.
- Addresses other than those listed above (for example location 0110) are special addresses used for test mode and other special IC functions. Do not set these locations.
- The default values are the values reloaded into the internal registers when a reset signal (RST) is received. These values are the recommended values for normal operation, and normally do not need to be modified. If only the default values are used, there is no need to provide data transfer routines in the external CPU or microcontroller.

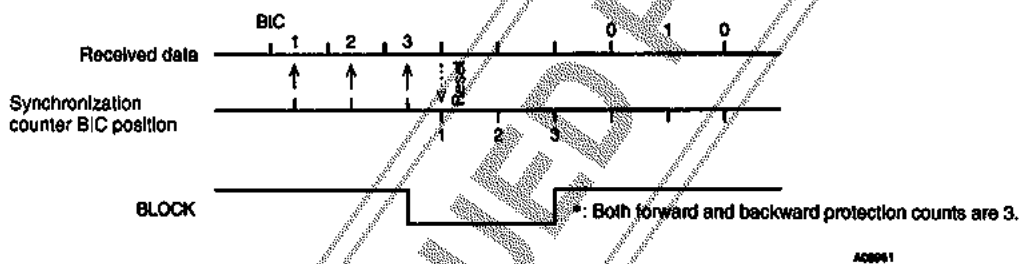

Figure 1 Block Synchronization Protection Operation (forward → backward → forward)

Layer 4 CRC Check Circuit

This is a function provided for data group error detection, i.e. layer 4 CRC. After the stipulated number of bytes of data group data and a 16-bit CRC error check word are transferred, the CRC4 pin outputs a high level if there were no errors. The CRC4 pin outputs a high level if all the bits in the IC internal CRC check register were 0. When using this function to perform the layer 4 CRC check, the IC internal CRC check register must be initialized before a single data group data unit is transferred. This register is initialized by sending bit 7 of the control register. Note that since this flag is not automatically reset to 0, the application must return it to 0 before transferring layer 4 CRC check data. If there were no errors in any of the received data groups, the CRC register will always be all zeros after the CRC check of a single data group. Therefore, the above control register initialization will not be necessary as long as there are no errors in the layer 4 CRC. The data length of the transferred data group data is in unit of 8 bits. Also note that while there is no upper limit on the amount of data transferred in a single operation, data transfers can also be divided into multiple transfer operations.

Control Register

	0	1	2	3	4	5	6	7
Control register	FRAME	RTIB	VEC HALT	EC STOP	SYNC RST	INT MOVE	DO MOVE	CRC4 RST

Bit	Function		Initial value
	L	H	
0	FRAME	L Method-B	L
		H Method-A	
1	RTIB	L Real-time information blocks present (When method A is selected)	L
		H No real-time information blocks present (When method A is selected)	
2	VEC HALT	L Vertical correction and second horizontal correction: enabled	L
		H Vertical correction and second horizontal correction: disabled	
3	EC STOP	L All functions operate.	L
		H Only the MSK detection and synchronization regeneration circuits operate.	
4	SYNC RST	L	L
		H Only the synchronization circuit is reset.	
5	INT MOVE	L Only the correction complete, layer 2 CRC complete, and data received while synchronized are output.	L
		H All data is output. (Operation identical to that of the LC72700E)	
6	DO MOVE	L The high-level (high-impedance) state is held at times other than data output.	L
		H The DO pin changes with the INT pin. (Operation identical to that of the LC72700E)	
7	CRC4 RST	L	L
		H The layer 4 CRC circuit is reset to its initial state.	

Detailed Descriptions

• VEC HALT

Setting this flag stops all IC operations related to vertical and second horizontal correction. Data output is limited to data following the first correction.

• EC STOP

This flag stops all operations (including RAM access) related to error correction and all data output operations. While all IC operations are stopped in standby mode, MSK demodulation, the synchronization circuit, the serial data input circuit, and the layer 4 CRC circuit continue to operate in this mode.

• SYNC RST

Clears the synchronization state and the synchronization protection state in the synchronization block and sets that block to the unsynchronized state. This allows quick frame synchronization pull in when, during receiver tuning operations, the frame period of the new reception data after station selection is displaced. While this flag is used for initialization of synchronization related circuits, it does not initialize the number of allowed BIC errors, the block synchronization forward and backward protection settings, and the frame synchronization forward and backward protection settings. During the synchronization block reset, the INT signal is not output and the DO pin outputs a high level (high impedance). Since this flag is not automatically reset to 0, applications must send data again to set it to 0.

• INT MOVE

The data output by this IC is fully corrected, and only data received during both block and frame synchronization is output. (The level 2 CRC check is included.) This flag must be set to acquire all data in the same manner as the LC72700.

• DO MOVE

In the LC72700, the DO pin output was linked to and changed with the INT signal so that it could be used in place of the INT CPU interrupt signal. Set this flag to use that function.

• RTIB

In the method A frame structure in the ITU-R recommendations, a total of 12 data blocks have been inserted in the parity data area, in which the 82 consecutive blocks of parity information are held. This flag must be set if this IC is used in systems that do not have these real-time information blocks (RTIB). Note that if the state of this flag is changed, frame synchronization will be held for the time corresponding to the forward protection count and then will switch to the unsynchronized state. Applications must use the SYNC RST flag to reset the synchronization circuit to reestablish frame synchronization more quickly.

Structure of the Output Data

- The output data consists of a total of 288 bits (36 bytes). The first two bytes are status information, and data is output in a single data block unit.
- CNT1 and CNT2 are output LSB first.
- The corrected data is output starting with the first bit in the data block.
- BIC codes are not output.

Note: The CPU can easily select data by discriminating the status information at first during data readout. Data that is determined to be unnecessary can be immediately cancelled without reading it out. (The CPU can simply ignore the data until the next interrupt arrives.)

For example, the CPU can also read out just the first 22 bytes (the data block section) of the corrected data, and does not have to read out the unrequired 12 bytes (the layer 2 CRC and parity data).

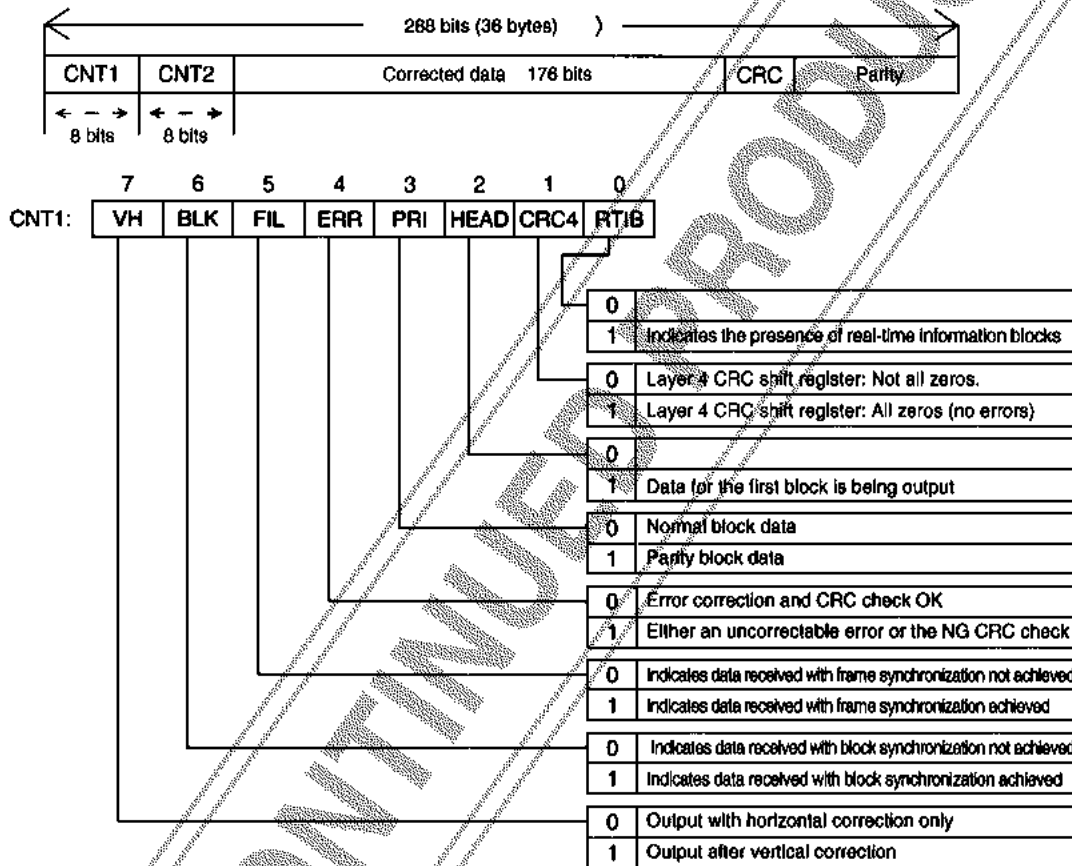

A08982

Notes:

- CRC indicates the layer 2 CRC check when the ERR flag is 1.
- The CRC4 result is the data immediately preceding the point when the CCB output address (#FB) was input and CE was high.
- The HEAD flag is only valid for horizontal correction data output, i.e. when VH is 0.
- The RTIB flag is only valid for method A.

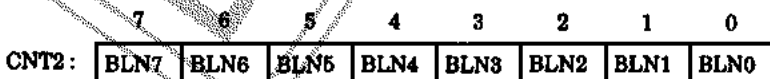

BLNK0 to BLNK7: Indicates either the block number for the output data or the parity block number. The data blocks in a single frame are numbered 0 to 189, and the parity blocks are numbered 0 to 81.

Parity block data is not output for post-vertical correction output.

Operation During Reset and in Standby Mode

• The Reset Signal

A reset operation is performed by holding the RST pin input level under V_{IL} for at least 300 ns when the power-supply voltage (V_{DD}) is over 3.4 V (or over 2.5 V when a 3-V V_{DD} is used.) See the figure below. Applications must apply a reset when power is first applied or when power is reapplied.

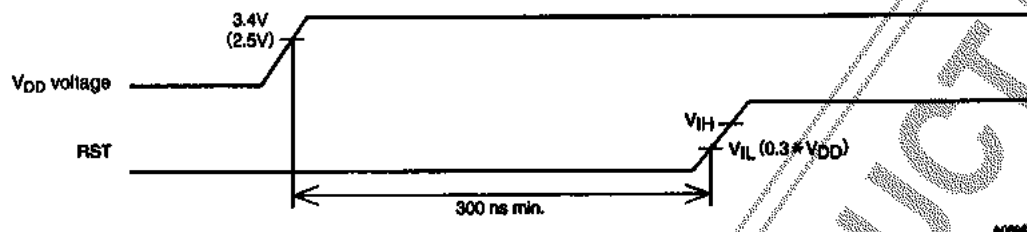

• Pin Outputs During a Reset

Low-level outputs: FILCK (4), CLK16 (10), DATA (11), FLOCK (22), BLOCK (23), CRC4 (24), IC0 (34) to IC3 (37), IC4 (39), IC5 (41), IC6 (42)

High-level outputs: INT (25), XOUT (2)

Open: DO (29)

• Reset Operating Range

The output pin states according to the reset signal are stipulated by item "Pin outputs during a reset" above. The IC internal flip-flops are all reset. Although the delay shift registers are also reset, the memory array is not influenced. However, since memory refresh operation stops, data cannot be retained. The crystal oscillator circuit does not stop.

• Data Input After a Reset

After a reset completes and at least one full clock cycle (about 278 ns at 3.6 MHz, this is the IC's main clock) has elapsed, the serial input control circuit will be able to operate and accept data.

• Standby Mode

The IC can be set to standby mode by setting the STNBY pin high. Since all IC operations are stopped in this mode, this produces a state essentially equivalent to the power off state. (Note that after standby mode has been cleared, a wait period is required until the crystal oscillator circuit is operating stably.) The pin output states in standby mode are identical to the states after a reset as described in item "Pin outputs during a reset" above.

Notes on Post Error Correction Output Data

• The received data is error corrected using (272, 190) codes in single block (272 bits) unit. An error check using the layer 2 CRC is also performed. After error correction, the IC prepares for transfer of the data to the CPU and outputs the INT signal. This is referred to as horizontal correction output.

• However, the INT signal is not output at this time if the corresponding output data does not meet all of the following three conditions.

- Error correction completed and it passed the layer 2 CRC check.
- The data was received while both block and frame synchronization were established.
- The data was packet data.

Note that all received packet data can be acquired by setting bit 5 (INT) in the control register.

• If the data could not be corrected by the horizontal correction system, correction using product codes is performed in frame units. This is called vertical correction. The data that can be acquired at the output of the vertical correction is the following.

- Data that was fully corrected in horizontal correction is not output.
- Packet data that could not be corrected by horizontal correction but that was fully corrected by vertical correction is output.
- Packet data that could not be corrected by either horizontal or vertical correction is not output.

Note that, as is the case for horizontal correction output, all received packet data can be acquired by setting bit 5 (INT) in the control register. However, the parity packet data corrected by vertical correction cannot be output even if this flag bit is set.

- To prevent unnecessary error correction, the vertical correction is not applied to packets that were fully corrected by horizontal correction or to packets that had no errors.
- Vertical correction is executed when all packet data in the object data was received while frame synchronization was established and not all of the packet (block) data was corrected by horizontal correction. Vertical correction is not performed if a whole frame of data with no errors is received, or if the frame was not synchronized. Also, the corresponding post-vertical correction output data is not output.
- All data can be output, regardless of the correction complete/incomplete, synchronized/unsynchronized reception, data/packet status or other conditions by setting bit 5 (INT) in the control register to 1.

CPU Interface Basic Restrictions

To save internal memory, this IC uses the smallest possible output buffer. Since the data that the IC receives is written to memory without any breaks, if data readout is delayed post-correction data that should be read out will be overwritten by the next data to be output. The output timings in this IC for post-correction (horizontal and vertical) data are stipulated as follows.

- When preparation of the output data has completed, the IC issues a transfer request by setting the INT pin low.
- For data output, there are periods in which only horizontal data can be output and periods in which both horizontal data and vertical data can be output.
- Data transfers must be completed within about 9 ms after the INT pin goes low. For periods in which only post-horizontal correction data can be output, data can be transferred over a period of about 18 ms. Even if the CPU is in the midst of a read operation, the next output data will be written to the output buffer after the specified period elapses.
- Only one block of data can be read for a single transfer request (INT) for both vertical and horizontal correction. After vertical correction processing completes, the post-vertical correction data is output in order starting with block number 1, and the parity block data is not output.

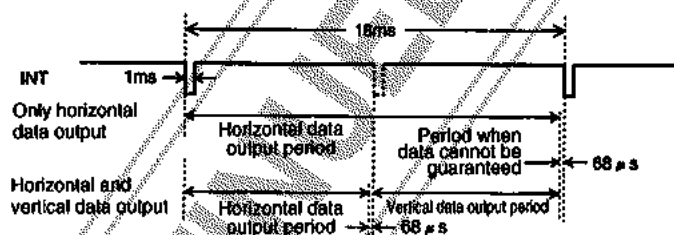

Figure 2 Basic Interface Timing

Notes on Data Output Timing (The relationship with the received data)

Figure 3 shows the timing relationship between the received data and the interrupt control signal INT. However, the delay component relative to the actually received signal due to the demodulation operations in the MSK demodulation block is ignored. Block synchronization is established by recognizing the BIC code. As shown in figure 3, the data for the n th packet can be output during the reception of the next packet, packet number $n + 1$.

Figure 4 shows the output timing for vertical correction data. Vertical correction is used when the data for a whole frame is stored in memory, frame synchronization is established, and furthermore horizontal correction was not able to correct all the packet data. The timing for the start of vertical correction execution is the head of the frame. During reception of packets 1 to 28 in the n th frame, horizontal correction is performed on each packet, data is passed to the CPU, and the remaining unused processing time during that interval is used to apply vertical correction to the data from the previous frame (frame $n - 1$). The post-vertical correction data (190 blocks of data) is output in order starting when the 29th packet (block) is received at the rate of one block of output data for every block received. Of the data in the FM multiplex broadcast frame structure, only the data in the data blocks is output, and the 190th block (the last data block) is output while the 218th block is being received. As discussed previously (page 10), of the post-vertical correction output data, the packet data for which horizontal correction completed fully is not output (the INT signal is not issued). However, it is not the case that the vertical output is speeded up by the amount of the packet data that is not output. For example, if data packets 1 to 100 were fully corrected in horizontal correction, the point that the 101st post-vertical correction packet data is output will not be the reception position block number 29 in figure 4, but the reception position of packet data number 129.

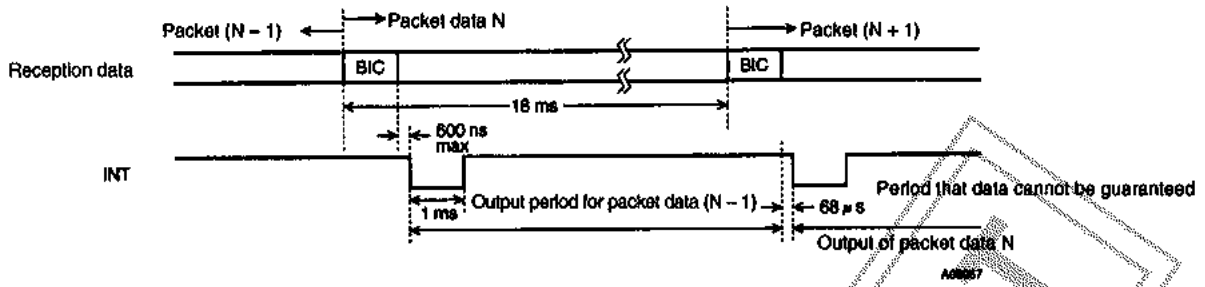

Figure 3 Timing of Data Reception and Block Synchronization Data Output

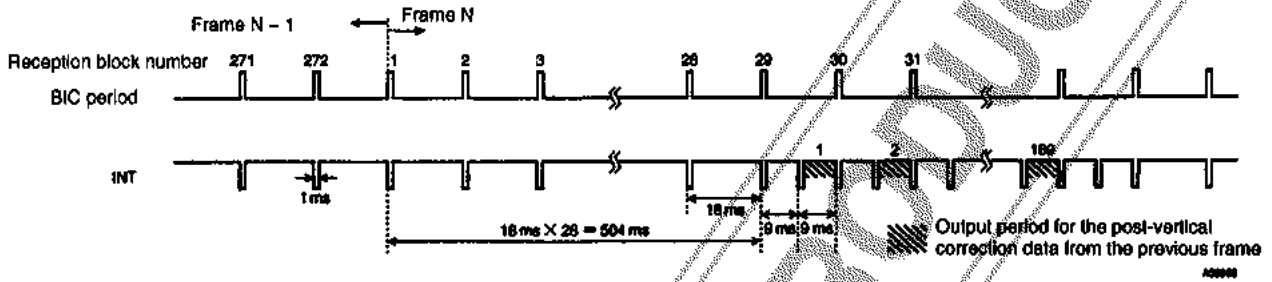

Figure 4 Vertical Correction Data Output Timing

Notes on Output Data Selection During Tuning (Provided for reference purposes.)

A tuning system is required in an FM multiplex broadcast reception system. However, applications must perform the following processing if it is unacceptable for the IC to output data for the previous station after tuning a new station.

- Set bit 4 (SYNC RST) in the control register during tuning to set the synchronization circuit to the unsynchronized state.
- If bit 5 (INT) in the control register is enabled, do not use the post-vertical correction output (data for which bit 7 in the status flags CNT1 is 1) until frame synchronization is re-established.

Of the DARC FM multiplex processing, this IC performs the processing through error correction (layer 2) without requiring any special control operations. The IC itself is not able to recognize whether the content of the received data has changed or whether the system has been tuned to another station. Therefore the application system must use the above procedure to command the IC not to output the old data and only to output the new data. The synchronization relationship between the stations is also problematic; although it is rare that the frames of the previous station and the next station would be synchronized, applications must also perform the processing described above to cancel the frame synchronization forward protection period.

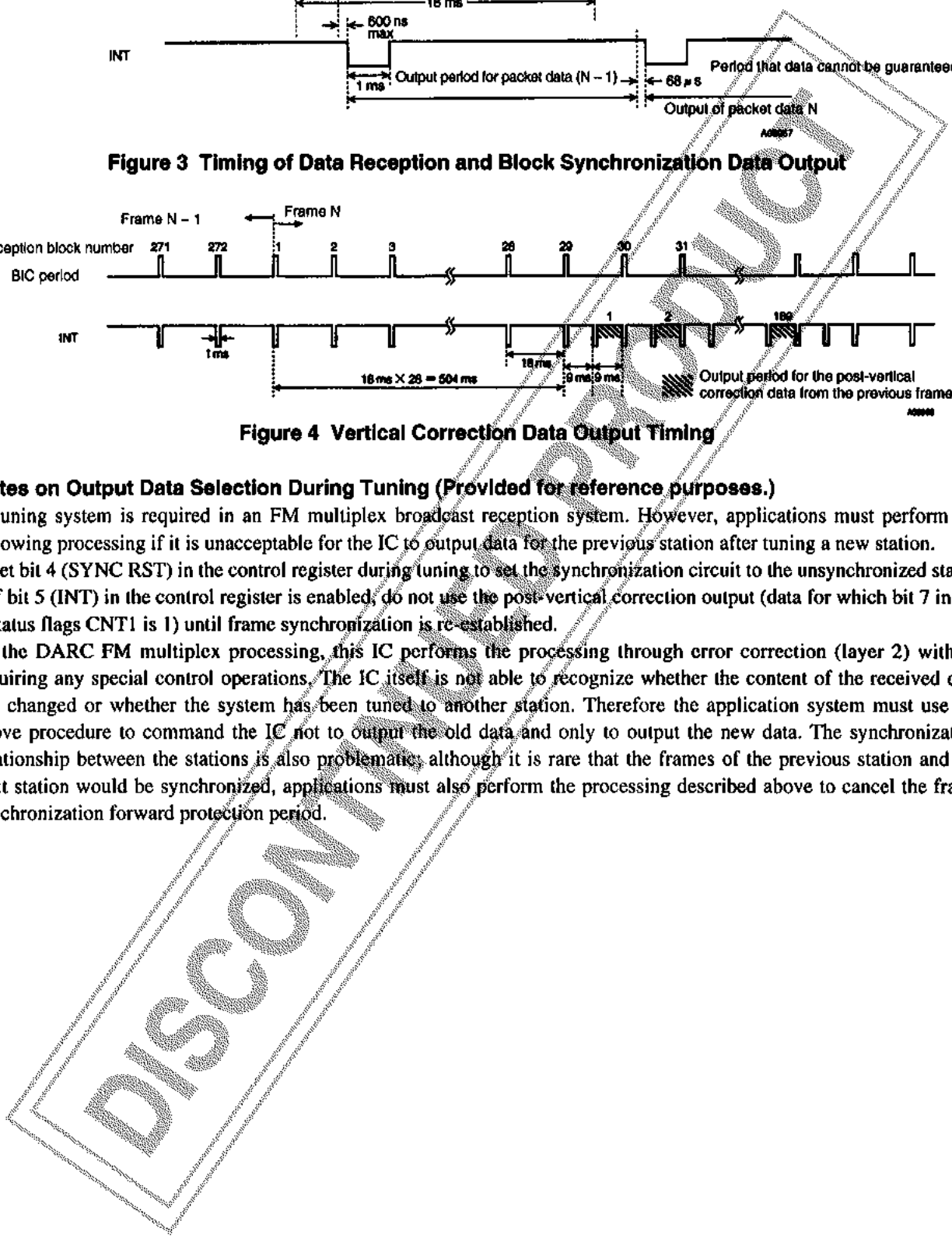

Differences in Data Output between this IC and the LC72700E (Provided for reference purposes.)

The LC72700E provided all data that could be provided to the microcontroller in the later stages of the system, and was designed so that the microcontroller was required to decide whether to accept or discard the data by checking the status output. For example, a received data packet could be output as post-horizontal correction data and then again, a few seconds later, could be output as post-vertical correction data. Data with no errors, or data that could be corrected by horizontal correction was output twice as identical data. This IC implements the conditions shown on page 10 (in "Notes on Post Error Correction Output Data") concerning data with no errors. Stated simply, this IC does not output data unnecessarily. For example, the INT signal will not be output for data from a received station that is not broadcasting multiplexed data. Also, under good reception conditions where there are no errors, there will be no post-vertical correction output and the INT signal period will be 18 ms.

There are cases where it may become impossible to acquire the data if the microcontroller software includes the data acquisition conditions required for the LC72700E. For example, this problem may occur if the software was designed to only use the post-vertical correction output. Since this IC does not output the same data twice and does not output bad data at all, applications do not need to select from the input data if they simply acquire all data that starts at every INT signal. (In other words, it can be also said that this IC does not generate any unnecessary interrupt signals.) To set up this IC to provide the same output format as that of the LC72700E, applications must set bit 5 (INT MODE) in the control register to 1. Note that this IC is added a control function that causes the IC not to output post-vertical correction data if the vertical correction operation was not executed. Since this control function is not influenced by the INT MOVE flag, post-vertical correction output is not provided during error-free reception even if the INT MOVE flag was set. Thus care is required in application software design.

Methods for Supporting the Different Frame Formats

Applications can handle the A, A', B, and C frame formats by setting bits 0 (FRAME), 1 (RTIB), and 2 (VEC HALT) in the control register appropriately. The default values are appropriate for method B. Note that since the IC itself does not provide any functions for recognizing the frame structure, applications must set these bits using the serial data transfer function.

METHOD	FRAME (Bit 0)	RTIB (Bit 1)	VEC HALT (Bit 2)	
A	H	H	L	No interleaves
A'	H	L	L	A + RTIB (*)
B	L	—	L	Interleaving
C	—	—	H	Block data only

(*) RTIB: Real Time Information Blocks

While the VEC HALT flag allows method C to be handled, the information related to the block number and the information related to frame synchronization in the status output will be invalid.

Invalid status:

CNT1: Bit 5 FIL	Frame synchronization information
CNT1: Bit 3 PRI	Parity packet information
CNT1: Bit 2 HEAD	Frame head information
CNT1: Bit 0 RTIB	RTIB information
CNT2:	Data block number and parity packet number information

Connection Example (Provided for reference purposes.)

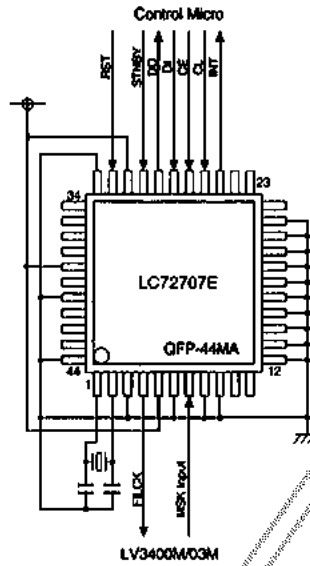

SWIFT Frame Structure (Provided for reference purposes.)

60 BLOCKS	BIC3	Data blocks (1 to 60)	CRC	Parity (horizontal)
	BIC3		CRC	
70 BLOCKS	BIC2	Data blocks (61 to 130)	CRC	Parity (horizontal)
	BIC2		CRC	
60 BLOCKS	BIC1	Data blocks (131 to 180)	CRC	Parity (horizontal)
	BIC1		CRC	
20 BLOCKS	BIC4	Parity blocks (vertical) 20 blocks		
21 BLOCKS	BIC2	Real time information blocks (4 blocks)	CRC	Parity (horizontal)
	BIC4	Parity blocks (vertical) 21 blocks		
21 BLOCKS	BIC2	Real time information blocks (4 blocks)	CRC	Parity (horizontal)
	BIC4	Parity blocks (vertical) 21 blocks		
20 BLOCKS	BIC2	Real time information blocks (4 blocks)	CRC	Parity (horizontal)
	BIC4	Parity blocks (vertical) 20 blocks		
		16 bits	14 bits	82 bits
		190 bits		

A0999

While horizontal correction is performed for the real-time information blocks (RTIB), vertical correction is not. The vertical correction process uses 272 packets that do not include the RTIB, which consists of 12 packets. The time required to transmit a single frame is 5.112 seconds, which is 18 ms × 284.

Address inquiries concerning DRIS system to : Digital DJ
 Incorporated
 1375 McCandless Drive
 Milpitas, CA 95035-8023
 Telephone : +1-408-946-8500
 Facsimile : +1-408-946-8600
 Japan Research & development Center
 The 2nd Umemura Bldg., 3-24-3
 Yoyogi, Shibuya-ku, Tokyo 151 Japan
 Telephone : +81-3-5352-6924
 Facsimile : +81-3-5352-6925



Address inquiries concerning contracts to:
 NHK Engineering Services
 Telephone: +81-3-3417-4840

The DARC (Data Radio Channel) FM multiplex broadcast technology was developed by NHK (Japan Broadcasting Corporation). DARC is a registered trademark of NHK Engineering Service (NHK-ES).
 A separate contract with NHK-ES is required in advance for the manufacture and/or sale of electronic equipment that uses DARC technology. Note that the logo shown here can be displayed on electronic equipment that uses DARC technology.

Announcement

Sanyo Electric Co., Ltd. reports to NHK-ES data for the number of units of this IC shipped after October 1997. (However, this does not apply to samples.)

- No products described or contained herein are intended for use in surgical implants, life-support systems, aerospace equipment, nuclear power control systems, vehicles, disaster/crime-prevention equipment and the like, the failure of which may directly or indirectly cause injury, death or property loss.
- Anyone purchasing any products described or contained herein for an above-mentioned use shall:
 - ① Accept full responsibility and indemnify and defend SANYO ELECTRIC CO., LTD., its affiliates, subsidiaries and distributors and all their officers and employees, jointly and severally, against any and all claims and litigation and all damages, cost and expenses associated with such use:
 - ② Not impose any responsibility for any fault or negligence which may be cited in any such claim or litigation on SANYO ELECTRIC CO., LTD., its affiliates, subsidiaries and distributors or any of their officers and employees jointly or severally.
- Information (including circuit diagrams and circuit parameters) herein is for example only; it is not guaranteed for volume production. SANYO believes information herein is accurate and reliable, but no guarantees are made or implied regarding its use or any infringements of intellectual property rights or other rights of third parties.

This catalog provides information as of May, 1998. Specifications and information herein are subject to change without notice.