

**SANYO**

No. 5112

**LC72132, 72132M****AM/FM PLL Frequency Synthesizer****Overview**

The LC72132 and LC72132M are PLL frequency synthesizers for use in tuners in radio/cassette players. They allow high-performance AM/FM tuners to be implemented easily.

**Functions**

- High-speed programmable dividers
  - FMIN: 10 to 160 MHz .....pulse swallower  
(built-in divide-by-two prescaler)
  - AMIN: 2 to 40 MHz .....pulse swallower  
0.5 to 10 MHz .....direct division
- IF counter
  - IFIN: 0.4 to 12 MHz .....AM/FM IF counter
- Reference frequencies
  - Twelve selectable frequencies  
(4.5 or 7.2 MHz crystal)  
1, 3, 5, 9, 10, 3.125, 6.25, 12.5, 15, 25, 50 and 100 kHz
- Phase comparator
  - Dead-zone control
  - Unlock detection circuit
  - Deadlock clear circuit
- Built-in MOS transistor for forming an active low-pass filter
- I/O ports
  - Dedicated output ports: 2
  - Input or output ports: 2
  - Support clock time base output
- Serial data I/O
  - Support CCB format communication with the system controller.
- Operating ranges
  - Supply voltage.....4.5 to 5.5 V
  - Operating temperature.....-40 to +85°C
- Packages
  - DIP16/MFP16

- CCB is a trademark of SANYO ELECTRIC CO., LTD.
- CCB is SANYO's original bus format and all the bus addresses are controlled by SANYO.

**Package Dimensions**

unit: mm

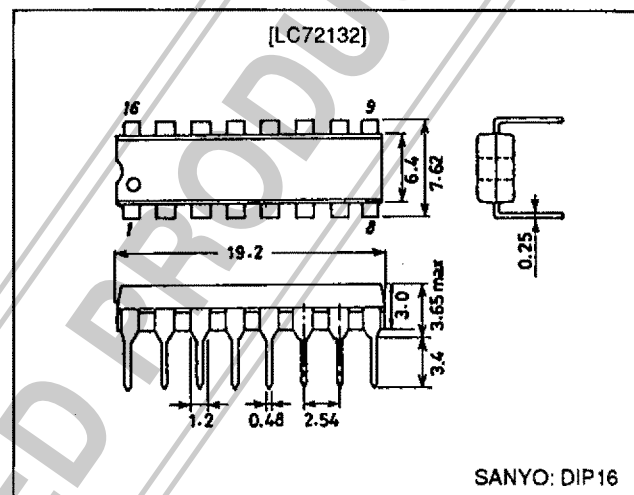
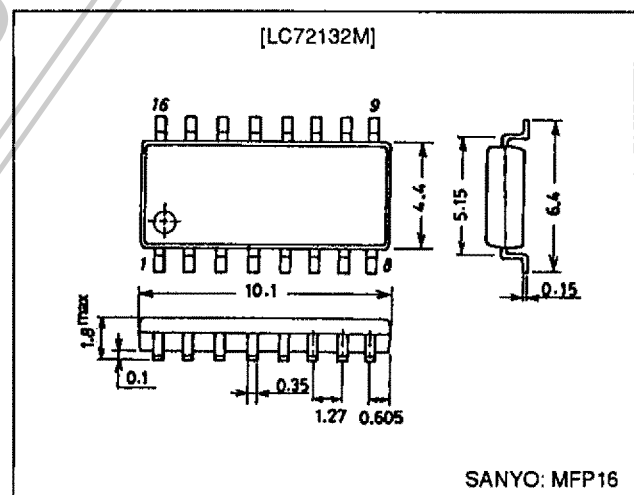
**3006B-DIP16****3035A-MFP16**

Pin Assignment

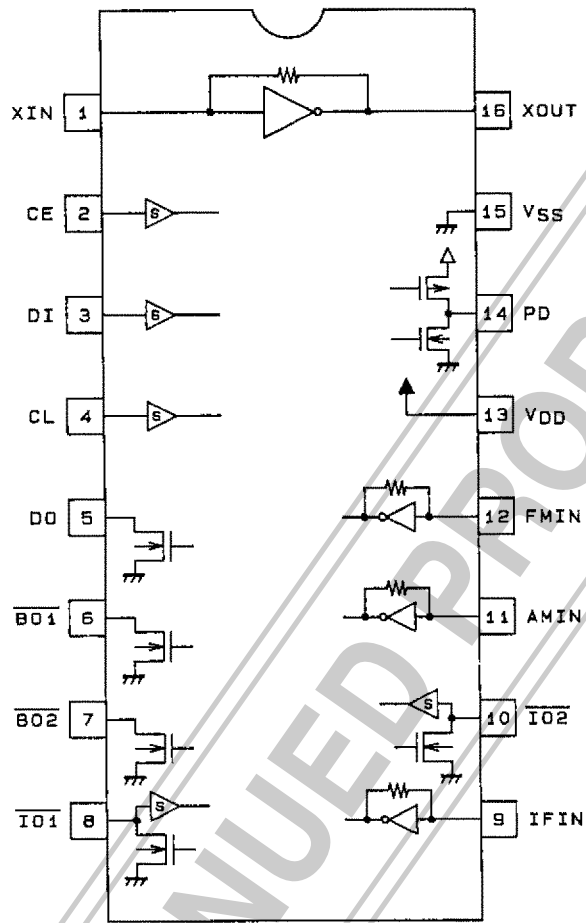

Top view

A03986

DISCONTINUED PRODUCT

Block Diagram

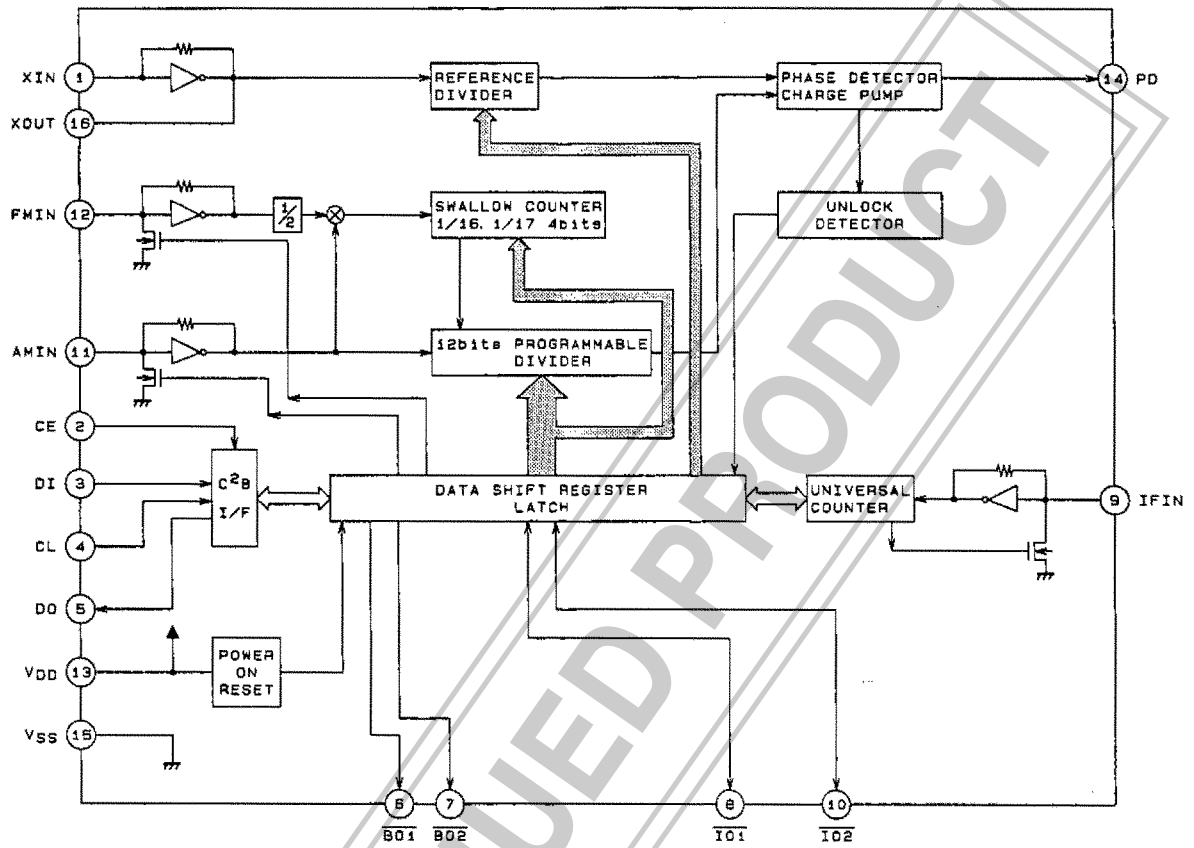

A03887

DISCONTINUED PRODUCT

## Specifications

Absolute Maximum Ratings at  $T_a = 25^\circ\text{C}$ ,  $V_{SS} = 0\text{ V}$

Parameter	Symbol	Pins	Ratings	Unit
Supply voltage	$V_{DD\text{ max}}$	$V_{DD}$	-0.3 to +7.0	V
Maximum input voltage	$V_{IN1\text{ max}}$	CE, CL, DI	-0.3 to +7.0	V
	$V_{IN2\text{ max}}$	XIN, FMIN, AMIN, IFIN	-0.3 to $V_{DD} + 0.3$	V
	$V_{IN3\text{ max}}$	$\overline{IO1}$ , $\overline{IO2}$	-0.3 to +15	V
Maximum output voltage	$V_{O1\text{ max}}$	DO	-0.3 to +7.0	V
	$V_{O2\text{ max}}$	XOUT, PD	-0.3 to $V_{DD} + 0.3$	V
	$V_{O3\text{ max}}$	$\overline{BO1}$ , $\overline{BO2}$ , $\overline{IO1}$ , $\overline{IO2}$	-0.3 to +15	V
Maximum output current	$I_{O1\text{ max}}$	$\overline{BO1}$	0 to +3.0	mA
	$I_{O2\text{ max}}$	DO	0 to +6.0	mA
	$I_{O3\text{ max}}$	$\overline{BO2}$ , $\overline{IO1}$ , $\overline{IO2}$	0 to +10.0	mA
Allowable power dissipation	$P_d\text{ max}$	$T_a \leq 85^\circ\text{C}$ [LC72132] DIP16 $T_a \leq 85^\circ\text{C}$ [LC72132M] MFP16	300 140	mW
Operating temperature	$T_{opr}$		-40 to +85	$^\circ\text{C}$
Storage temperature	$T_{stg}$		-55 to +125	$^\circ\text{C}$

Allowable Operating Ranges at  $T_a = -40$  to  $+85^\circ\text{C}$ ,  $V_{SS} = 0\text{ V}$

Parameter	Symbol	Pins	Conditions	min	typ	max	Unit
Supply voltage	$V_{DD}$	$V_{DD}$		4.5		5.5	V
Input high-level voltage	$V_{IH1}$	CE, CL, DI		$0.7 V_{DD}$		6.5	V
	$V_{IH2}$	$\overline{IO1}$ , $\overline{IO2}$		$0.7 V_{DD}$		13	V
Input low-level voltage	$V_{IL}$	CE, CL, DI, $\overline{IO1}$ , $\overline{IO2}$		0		$0.3 V_{DD}$	V
Output voltage	$V_{O1}$	DO		0		6.5	V
	$V_{O2}$	$\overline{BO1}$ , $\overline{BO2}$ , $\overline{IO1}$ , $\overline{IO2}$		0		13	V
Input frequency	$f_{IN1}$	XIN	$V_{IN1}$	1		8	MHz
	$f_{IN2}$	FMIN	$V_{IN2}$	10		160	MHz
	$f_{IN3}$	AMIN	$V_{IN3}$ , SNS = 1	2		40	MHz
	$f_{IN4}$	AMIN	$V_{IN4}$ , SNS = 0	0.5		10	MHz
	$f_{IN5}$	IFIN	$V_{IN5}$	0.4		12	MHz
Input amplitude	$V_{IN1}$	XIN	$f_{IN1}$	400		1500	mVrms
	$V_{IN2-1}$	FMIN	$f = 10$ to 130 MHz	40		1500	mVrms
	$V_{IN2-2}$	FMIN	$f = 130$ to 160 MHz	70		1500	mVrms
	$V_{IN3}$	AMIN	$f_{IN3}$ , SNS = 1	40		1500	mVrms
	$V_{IN4}$	AMIN	$f_{IN4}$ , SNS = 0	40		1500	mVrms
	$V_{IN5-1}$	IFIN	$f_{IN5}$ , IFS = 1	40		1500	mVrms
Supported crystals	$X_{tal}$	XIN, XOUT	*	4.0		8.0	MHz

Note: \* Recommended crystal oscillator CI values:  
 $CI \leq 120\ \Omega$  (For a 4.5 MHz crystal)  
 $CI \leq 70\ \Omega$  (For a 7.2 MHz crystal)

<Sample Oscillator Circuit>

Crystal oscillator: HC-49/U (manufactured by Kinseki, Ltd.),  $CL = 12\text{ pF}$   
 $C1 = C2 = 15\text{ pF}$



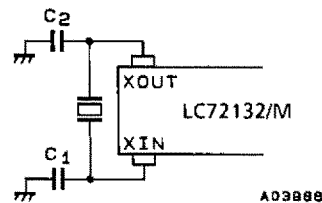

The circuit constants for the crystal oscillator circuit depend on the crystal used, the printed circuit board pattern, and other items. Therefore we recommend consulting with the manufacturer of the crystal for evaluation and reliability.

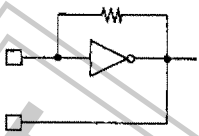
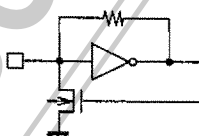
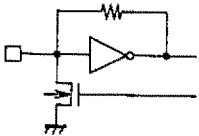

Electrical Characteristics for the Allowable Operating Ranges at  $T_a = -40$  to  $+85^\circ\text{C}$ ,  $V_{SS} = 0\text{ V}$ 

Parameter	Symbol	Pins	Conditions	min	typ	max	Unit
Built-in feedback resistance	Rf1	XIN			1.0		M $\Omega$
	Rf2	FMIN			500		k $\Omega$
	Rf3	AMIN			500		k $\Omega$
	Rf4	IFIN			250		k $\Omega$
Built-in pull-down resistor	Rpd1	FMIN			200		k $\Omega$
	Rpd2	AMIN			200		k $\Omega$
Hysteresis	V <sub>HIS</sub>	CE, CL, DI, $\overline{\text{IO1}}$ , $\overline{\text{IO2}}$			0.1 V <sub>DD</sub>		V
Output high level voltage	V <sub>OH1</sub>	PD	I <sub>O</sub> = -1 mA	V <sub>DD</sub> - 1.0			V
Output low level voltage	V <sub>OL1</sub>	PD	I <sub>O</sub> = 1 mA			1.0	V
			I <sub>O</sub> = 0.5 mA			0.5	V
	V <sub>OL2</sub>	$\overline{\text{BOT}}$	I <sub>O</sub> = 1 mA			1.0	V
			I <sub>O</sub> = 5 mA			0.2	V
	V <sub>OL3</sub>	DO	I <sub>O</sub> = 1 mA			1.0	V
			I <sub>O</sub> = 5 mA			0.2	V
I <sub>O</sub> = 8 mA					1.0	V	
V <sub>OL4</sub>	$\overline{\text{BO2}}$ , $\overline{\text{IO1}}$ , $\overline{\text{IO2}}$	I <sub>O</sub> = 1 mA			0.2	V	
		I <sub>O</sub> = 5 mA			1.0	V	
		I <sub>O</sub> = 8 mA			1.6	V	
Input high level current	I <sub>IH1</sub>	CE, CL, DI	V <sub>I</sub> = 6.5 V			5.0	$\mu\text{A}$
	I <sub>IH2</sub>	$\overline{\text{IO1}}$ , $\overline{\text{IO2}}$	V <sub>I</sub> = 13 V			5.0	$\mu\text{A}$
	I <sub>IH3</sub>	XIN	V <sub>I</sub> = V <sub>DD</sub>	2.0		11	$\mu\text{A}$
	I <sub>IH4</sub>	FMIN, AMIN	V <sub>I</sub> = V <sub>DD</sub>	4.0		22	$\mu\text{A}$
	I <sub>IH5</sub>	IFIN	V <sub>I</sub> = V <sub>DD</sub>	8.0		44	$\mu\text{A}$
Input low level current	I <sub>IL1</sub>	CE, CL, DI	V <sub>I</sub> = 0 V			5.0	$\mu\text{A}$
	I <sub>IL2</sub>	$\overline{\text{IO1}}$ , $\overline{\text{IO2}}$	V <sub>I</sub> = 0 V			5.0	$\mu\text{A}$
	I <sub>IL3</sub>	XIN	V <sub>I</sub> = 0 V	2.0		11	$\mu\text{A}$
	I <sub>IL4</sub>	FMIN, AMIN	V <sub>I</sub> = 0 V	4.0		22	$\mu\text{A}$
	I <sub>IL5</sub>	IFIN	V <sub>I</sub> = 0 V	8.0		44	$\mu\text{A}$
Output off leakage current	I <sub>OFF1</sub>	$\overline{\text{BO1}}$ , $\overline{\text{BO2}}$ , $\overline{\text{IO1}}$ , $\overline{\text{IO2}}$	V <sub>O</sub> = 13 V			5.0	$\mu\text{A}$
	I <sub>OFF2</sub>	DO	V <sub>O</sub> = 6.5 V			5.0	$\mu\text{A}$
High level three-state off leakage current	I <sub>OFFH</sub>	PD	V <sub>O</sub> = V <sub>DD</sub>		0.01	200	nA
Low level three-state off leakage current	I <sub>OFFL</sub>	PD	V <sub>O</sub> = 0 V		0.01	200	nA
Input capacitance	C <sub>IN</sub>	FMIN			6		pF
Current drain	I <sub>DD1</sub>	V <sub>DD</sub>	Xtal = 7.2 MHz, f <sub>IN2</sub> = 130 MHz, V <sub>IN2</sub> = 40 mVrms		5	10	mA
	I <sub>DD2</sub>	V <sub>DD</sub>	PLL block stopped (PLL INHIBIT), Xtal oscillator operating (Xtal = 7.2 MHz)		0.5		mA
	I <sub>DD3</sub>	V <sub>DD</sub>	PLL block stopped Xtal oscillator stopped			10	$\mu\text{A}$

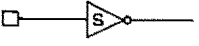
Pin Functions

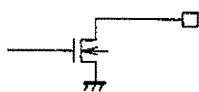
Symbol	Pin No. (MFP pin Nos. are in parentheses.)	Type	Functions	Circuit configuration
XIN XOUT	1 16	Xtal OSC	<ul style="list-style-type: none"> <li>Crystal resonator connection (4.5/7.2 MHz)</li> </ul>	 <p>A02598</p>
FMIN	12	Local oscillator signal input	<ul style="list-style-type: none"> <li>FMIN is selected when the serial data input DVS bit is set to 1.</li> <li>The input frequency range is from 10 to 160 MHz.</li> <li>The input signal passes through the internal divide-by-two prescaler and is input to the swallow counter.</li> <li>The divisor can be in the range 272 to 65535. However, since the signal has passed through the divide-by-two prescaler, the actual divisor is twice the set value.</li> </ul>	 <p>A02599</p>
AMIN	11	Local oscillator signal input	<ul style="list-style-type: none"> <li>AMIN is selected when the serial data input DVS bit is set to 0.</li> <li>When the serial data input SNS bit is set to 1:                             <ul style="list-style-type: none"> <li>The input frequency range is 2 to 40 MHz.</li> <li>The signal is directly input to the swallow counter.</li> <li>The divisor can be in the range 272 to 65535, and the divisor used will be the value set.</li> </ul> </li> <li>When the serial data input SNS bit is set to 0:                             <ul style="list-style-type: none"> <li>The input frequency range is 0.5 to 10 MHz.</li> <li>The signal is directly input to a 12-bit programmable divider.</li> <li>The divisor can be in the range 4 to 4095, and the divisor used will be the value set.</li> </ul> </li> </ul>	 <p>A02599</p>
CE	2	Chip enable	Set this pin high when inputting (DI) or outputting (DO) serial data.	 <p>A02600</p>
CL	4	Clock	Used as the synchronization clock when inputting (DI) or outputting (DO) serial data.	 <p>A02600</p>
DI	3	Data input	Inputs serial data transferred from the controller to the LC72132.	 <p>A02600</p>
DO	5	Data output	Outputs serial data transferred from the LC72132 to the controller. The content of the output data is determined by the serial data DOC0 to DOC2.	 <p>A02601</p>
VDD	13	Power supply	<ul style="list-style-type: none"> <li>The LC72132 power supply pin. (VDD = 4.5 to 5.5 V)</li> <li>The power-on reset circuit operates when power is first applied.</li> </ul>	

Continued on next page.

LC72132, 72132M

Continued from preceding page.

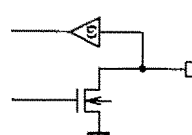
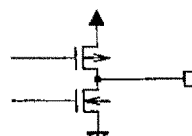
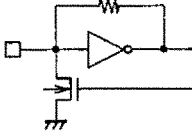
Symbol	Pin No. (MFP pin Nos. are in parentheses.)	Type	Functions	Circuit configuration
V <sub>SS</sub>	15	Ground	<ul style="list-style-type: none"> <li>The LC72132 ground</li> </ul>	—
$\overline{BO1}$ $\overline{BO2}$	6 7	Output port	<ul style="list-style-type: none"> <li>Dedicated output pins</li> <li>The output states are determined by <math>\overline{BO1}</math>, <math>\overline{BO2}</math> bits in the serial data. Data: 0 = open, 1 = low</li> <li>A time base signal (8 Hz) can be output from the <math>\overline{BO1}</math> pin. (When the serial data TBC bit is set to 1.)</li> <li>Care is required when using the <math>\overline{BO1}</math> pin, since it has a higher on impedance than the other output port (<math>\overline{BO2}</math>).</li> <li>All output ports are set to the open state following a power-on reset.</li> </ul>	 <p>A02601</p>
$\overline{IO1}$ $\overline{IO2}$	8 10	I/O port	<ul style="list-style-type: none"> <li>I/O dual-use pins</li> <li>The direction (input or output) is determined by bits <math>\overline{IOC1}</math> and <math>\overline{IOC2}</math> in the serial data. Data: 0 = input port, 1 = output port</li> <li>When specified for use as input ports: The state of the input pin is transmitted to the controller over the <math>\overline{DO}</math> pin. Input state: low = 0 data value                   high = 1 data value</li> <li>When specified for use as output ports: The output states are determined by the <math>\overline{IO1}</math> and <math>\overline{IO2}</math> bits in the serial data. Data: 0 = open, 1 = low</li> <li>These pins function as input pins following a power on reset.</li> </ul>	 <p>A02602</p>
PD	14	Charge pump output	<ul style="list-style-type: none"> <li>PLL charge pump output</li> <li>When the frequency generated by dividing the local oscillator frequency by N is higher than the reference frequency, a high level is output from the PD pin.</li> <li>Similarly, when that frequency is lower, a low level is output. The PD pin goes to the high impedance state when the frequencies match.</li> </ul>	 <p>A02603</p>
IFIN	9	IF counter	<ul style="list-style-type: none"> <li>Accepts an input in the frequency range 0.4 to 12 MHz.</li> <li>The input signal is directly transmitted to the IF counter.</li> <li>The result is output starting the MSB of the IF counter using the <math>\overline{DO}</math> pin.</li> <li>Four measurement periods are supported: 4, 8, 32, and 64 ms.</li> </ul>	 <p>A02609</p>

**Serial Data I/O Methods**

The LC72132 inputs and outputs data using the Sanyo CCB (computer control bus) audio LSI serial bus format. This LSI adopts an 8-bit address format CCB.

	I/O mode	Address								Function
		B0	B1	B2	B3	A0	A1	A2	A3	
1	IN1 (B2)	0	0	0	1	0	1	0	0	<ul style="list-style-type: none"> <li>Control data input mode (serial data input)</li> <li>24 data bits are input.</li> <li>See the "DI Control Data (serial data input) Structure" item for details on the meaning of the input data.</li> </ul>
2	IN2 (92)	1	0	0	1	0	1	0	0	<ul style="list-style-type: none"> <li>Control data input mode (serial data input)</li> <li>24 data bits are input.</li> <li>See the "DI Control Data (serial data input) Structure" item for details on the meaning of the input data.</li> </ul>
3	OUT (A2)	0	1	0	1	0	1	0	0	<ul style="list-style-type: none"> <li>Data output mode (serial data output)</li> <li>The number of bits output is equal to the number of clock cycles.</li> <li>See the "DO Output Data (Serial Data Output) Structure" item for details on the meaning of the output data.</li> </ul>

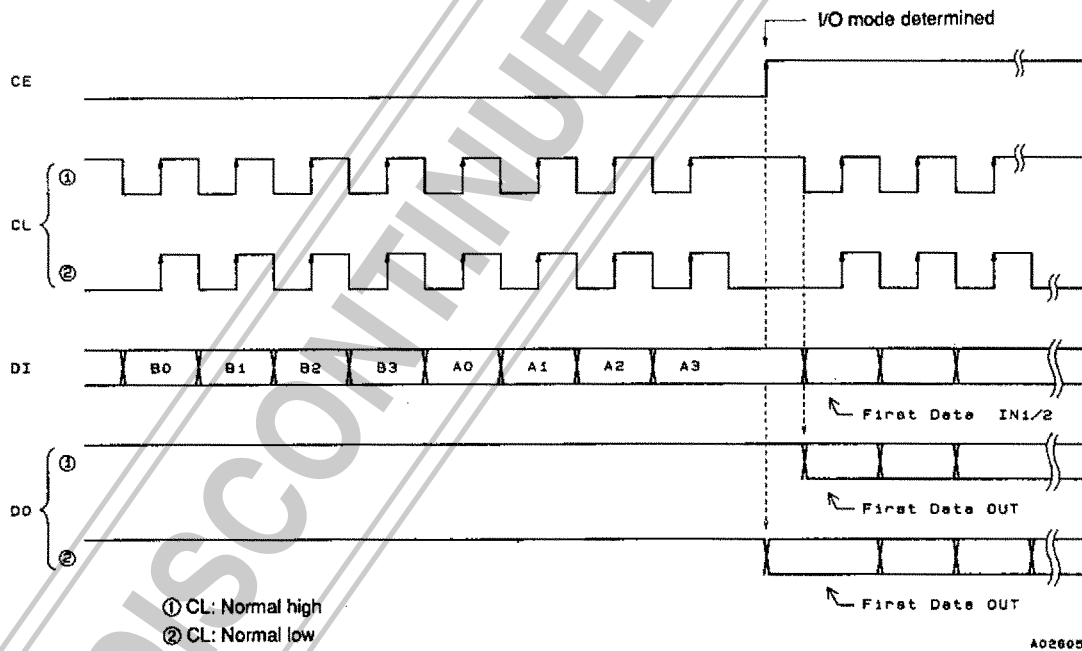

A02605



1. DI Control Data (Serial Data Input) Structure

- IN1 Mode

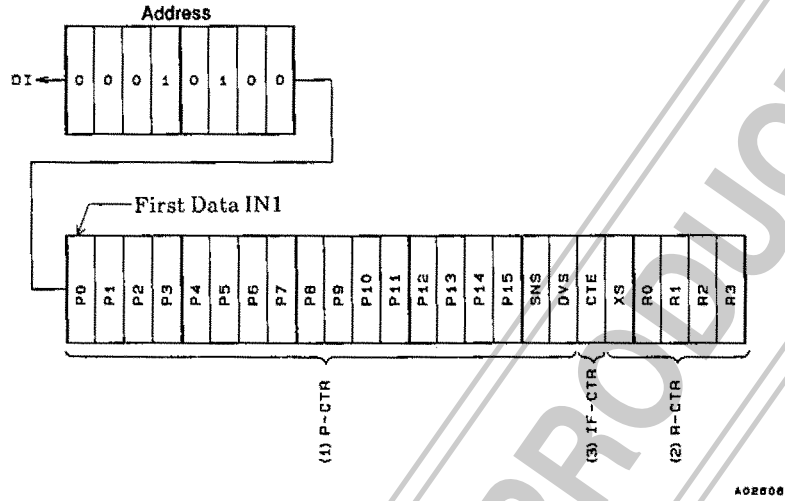

- IN2 Mode

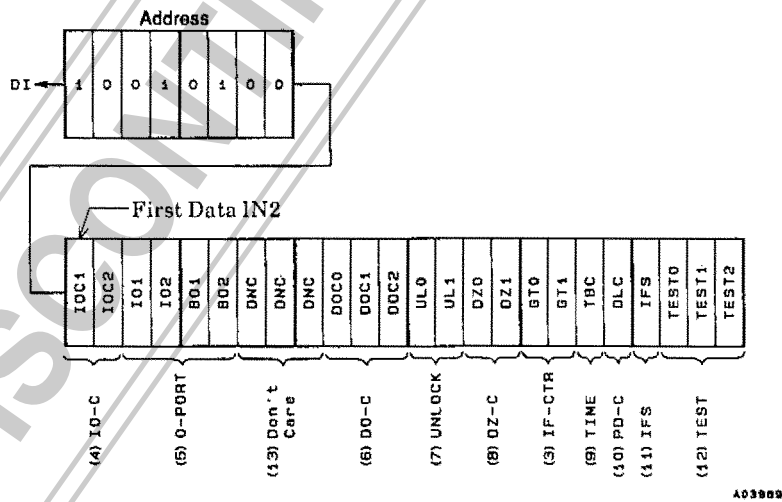

2. DI Control Data Functions

No.	Control block/data	Functions	Related data																																																																																					
(1)	Programmable divider data P0 to P15  DVS, SNS	<ul style="list-style-type: none"> <li>Data that sets the programmable divider. A binary value in which P15 is the MSB. The LSB changes depending on DVS and SNS. (*: don't care)</li> </ul> <table border="1"> <thead> <tr> <th>DVS</th> <th>SNS</th> <th>LSB</th> <th>Divisor setting (N)</th> <th>Actual divisor</th> </tr> </thead> <tbody> <tr> <td>1</td> <td>*</td> <td>P0</td> <td>272 to 65535</td> <td>Twice the value of the setting</td> </tr> <tr> <td>0</td> <td>1</td> <td>P0</td> <td>272 to 65535</td> <td>The value of the setting</td> </tr> <tr> <td>0</td> <td>0</td> <td>P4</td> <td>4 to 4095</td> <td>The value of the setting</td> </tr> </tbody> </table> <p>Note: P0 to P3 are ignored when P4 is the LSB.</p> <ul style="list-style-type: none"> <li>Selects the signal input pin (AMIN or FMIN) for the programmable divider, switches the input frequency range. (*: don't care)</li> </ul> <table border="1"> <thead> <tr> <th>DVS</th> <th>SNS</th> <th>Input pin</th> <th>Input frequency range</th> </tr> </thead> <tbody> <tr> <td>1</td> <td>*</td> <td>FMIN</td> <td>10 to 160 MHz</td> </tr> <tr> <td>0</td> <td>1</td> <td>AMIN</td> <td>2 to 40 MHz</td> </tr> <tr> <td>0</td> <td>0</td> <td>AMIN</td> <td>0.5 to 10 MHz</td> </tr> </tbody> </table> <p>Note: See the "Programmable Divider" item for more information.</p>	DVS	SNS	LSB	Divisor setting (N)	Actual divisor	1	*	P0	272 to 65535	Twice the value of the setting	0	1	P0	272 to 65535	The value of the setting	0	0	P4	4 to 4095	The value of the setting	DVS	SNS	Input pin	Input frequency range	1	*	FMIN	10 to 160 MHz	0	1	AMIN	2 to 40 MHz	0	0	AMIN	0.5 to 10 MHz																																																		
DVS	SNS	LSB	Divisor setting (N)	Actual divisor																																																																																				
1	*	P0	272 to 65535	Twice the value of the setting																																																																																				
0	1	P0	272 to 65535	The value of the setting																																																																																				
0	0	P4	4 to 4095	The value of the setting																																																																																				
DVS	SNS	Input pin	Input frequency range																																																																																					
1	*	FMIN	10 to 160 MHz																																																																																					
0	1	AMIN	2 to 40 MHz																																																																																					
0	0	AMIN	0.5 to 10 MHz																																																																																					
(2)	Reference divider data R0 to R3  XS	<ul style="list-style-type: none"> <li>Reference frequency (fref) selection data.</li> </ul> <table border="1"> <thead> <tr> <th>R3</th> <th>R2</th> <th>R1</th> <th>R0</th> <th>Reference frequency (kHz)</th> </tr> </thead> <tbody> <tr><td>0</td><td>0</td><td>0</td><td>0</td><td>100</td></tr> <tr><td>0</td><td>0</td><td>0</td><td>1</td><td>50</td></tr> <tr><td>0</td><td>0</td><td>1</td><td>0</td><td>25</td></tr> <tr><td>0</td><td>0</td><td>1</td><td>1</td><td>25</td></tr> <tr><td>0</td><td>1</td><td>0</td><td>0</td><td>12.5</td></tr> <tr><td>0</td><td>1</td><td>0</td><td>1</td><td>6.25</td></tr> <tr><td>0</td><td>1</td><td>1</td><td>0</td><td>3.125</td></tr> <tr><td>0</td><td>1</td><td>1</td><td>1</td><td>3.125</td></tr> <tr><td>1</td><td>0</td><td>0</td><td>0</td><td>10</td></tr> <tr><td>1</td><td>0</td><td>0</td><td>1</td><td>9</td></tr> <tr><td>1</td><td>0</td><td>1</td><td>0</td><td>5</td></tr> <tr><td>1</td><td>0</td><td>1</td><td>1</td><td>1</td></tr> <tr><td>1</td><td>1</td><td>0</td><td>0</td><td>3</td></tr> <tr><td>1</td><td>1</td><td>0</td><td>1</td><td>15</td></tr> <tr><td>1</td><td>1</td><td>1</td><td>0</td><td>PLL INHIBIT + Xtal OSC STOP</td></tr> <tr><td>1</td><td>1</td><td>1</td><td>1</td><td>PLL INHIBIT</td></tr> </tbody> </table> <p>Note: PLL INHIBIT The programmable divider block and the IF counter block are stopped, the FMIN, AMIN, and IFIN pins are set to the pull-down state (ground), and the charge pump goes to the high impedance state.</p> <ul style="list-style-type: none"> <li>Crystal resonator selection XS = 0: 4.5 MHz XS = 1: 7.2 MHz The 7.2 MHz frequency is selected after the power-on reset.</li> </ul>	R3	R2	R1	R0	Reference frequency (kHz)	0	0	0	0	100	0	0	0	1	50	0	0	1	0	25	0	0	1	1	25	0	1	0	0	12.5	0	1	0	1	6.25	0	1	1	0	3.125	0	1	1	1	3.125	1	0	0	0	10	1	0	0	1	9	1	0	1	0	5	1	0	1	1	1	1	1	0	0	3	1	1	0	1	15	1	1	1	0	PLL INHIBIT + Xtal OSC STOP	1	1	1	1	PLL INHIBIT	
R3	R2	R1	R0	Reference frequency (kHz)																																																																																				
0	0	0	0	100																																																																																				
0	0	0	1	50																																																																																				
0	0	1	0	25																																																																																				
0	0	1	1	25																																																																																				
0	1	0	0	12.5																																																																																				
0	1	0	1	6.25																																																																																				
0	1	1	0	3.125																																																																																				
0	1	1	1	3.125																																																																																				
1	0	0	0	10																																																																																				
1	0	0	1	9																																																																																				
1	0	1	0	5																																																																																				
1	0	1	1	1																																																																																				
1	1	0	0	3																																																																																				
1	1	0	1	15																																																																																				
1	1	1	0	PLL INHIBIT + Xtal OSC STOP																																																																																				
1	1	1	1	PLL INHIBIT																																																																																				
(3)	IF counter control data CTE  GT0, GT1	<ul style="list-style-type: none"> <li>IF counter measurement start data CTE = 1: Counter start CTE = 0: Counter reset</li> <li>Determines the IF counter measurement period.</li> </ul> <table border="1"> <thead> <tr> <th>GT1</th> <th>GT0</th> <th>Measurement time (ms)</th> <th>Wait time (ms)</th> </tr> </thead> <tbody> <tr> <td>0</td> <td>0</td> <td>4</td> <td>3 to 4</td> </tr> <tr> <td>0</td> <td>1</td> <td>8</td> <td>3 to 4</td> </tr> <tr> <td>1</td> <td>0</td> <td>32</td> <td>7 to 8</td> </tr> <tr> <td>1</td> <td>1</td> <td>64</td> <td>7 to 8</td> </tr> </tbody> </table> <p>Note: See the "IF Counter" item for more information.</p>	GT1	GT0	Measurement time (ms)	Wait time (ms)	0	0	4	3 to 4	0	1	8	3 to 4	1	0	32	7 to 8	1	1	64	7 to 8	IFS																																																																	
GT1	GT0	Measurement time (ms)	Wait time (ms)																																																																																					
0	0	4	3 to 4																																																																																					
0	1	8	3 to 4																																																																																					
1	0	32	7 to 8																																																																																					
1	1	64	7 to 8																																																																																					
(4)	I/O port specification data IOC1, IOC2	<ul style="list-style-type: none"> <li>Specifies the I/O direction for the bidirectional pins <math>\overline{IO1}</math> and <math>\overline{IO2}</math>. Data: 0 = input mode, 1 = output mode</li> </ul>																																																																																						
(5)	Output port data BO1, BO2, IO1, IO2	<ul style="list-style-type: none"> <li>Data that determines the output from the BO1, BO2, IO1 and IO2 output ports Data: 0 = open, 1 = low</li> <li>The data = 0 (open) state is selected after the power-on reset.</li> </ul>	IOC1 IOC2																																																																																					

Continued on next page.



Continued from preceding page.

No.	Control block/data	Functions	Related data
(11)	IF counter control data IFS	<ul style="list-style-type: none"> <li>Note that if this value is set to zero the system enters input sensitivity degradation mode, and the sensitivity is reduced to 10 to 30 mV rms.</li> <li>* See the "IF Counter Operation" item for details.</li> </ul>	
(12)	LSI test data TEST 0 to 3	<ul style="list-style-type: none"> <li>LSI test data TEST0 TEST1 TEST2 } These values must all be set to 0.</li> <li>These test data are set to 0 automatically after the power-on reset.</li> </ul>	
(13)	DNC	Don't care. This data must be set to 0.	

3. DO Output Data (Serial Data Output)

- OUT Mode

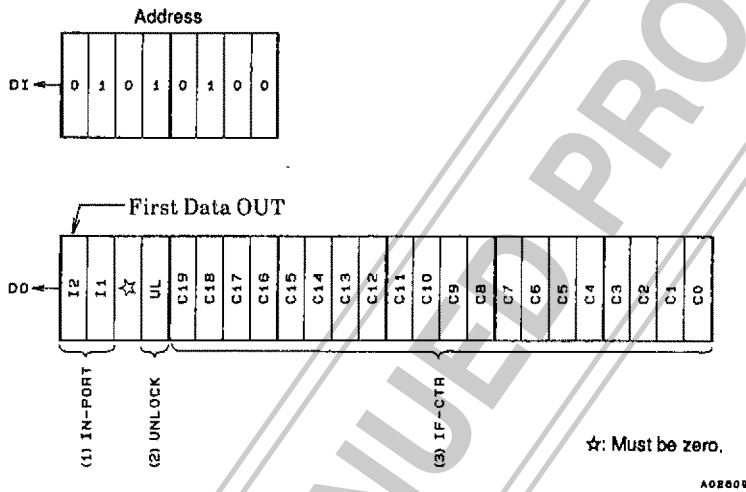

4. DO Output Data

No.	Control block/data	Functions	Related data
(1)	I/O port data I2, I1	<ul style="list-style-type: none"> <li>Latched from the pin states of the <math>\overline{IO1}</math> and <math>\overline{IO2}</math> I/O ports. (These values follow the pin states regardless of the input or output setting.)</li> <li>I1 ← <math>\overline{IO1}</math> pin state } High: 1</li> <li>I2 ← <math>\overline{IO2}</math> pin state } Low: 0</li> </ul>	IOC1, IOC2
(2)	PLL unlock data UL	<ul style="list-style-type: none"> <li>Latched from the state of the unlock detection circuit.</li> <li>UL ← 0: Unlocked</li> <li>UL ← 1: Locked or detection stopped mode</li> </ul>	UL0, UL1
(3)	IF counter binary data C19 to C0	<ul style="list-style-type: none"> <li>Latched from the value of the IF counter (20-bit binary counter).</li> <li>C19 ← MSB of the binary counter</li> <li>C0 ← LSB of the binary counter</li> </ul>	CTE, GT0, GT1

5. Serial Data Input (IN1/IN2)  $t_{SU}, t_{HD}, t_{EL}, t_{ES}, t_{EH} \geq 0.75 \mu s, t_{LC} \leq 0.75 \mu s$

① CL: Normal high

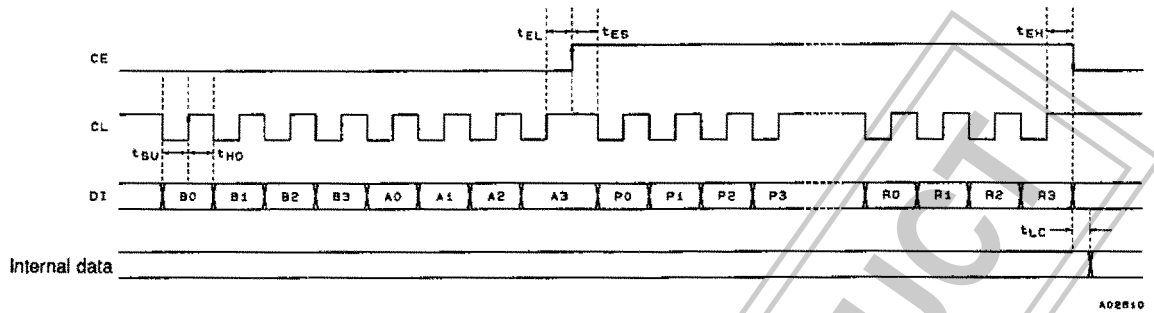

② CL: Normal low

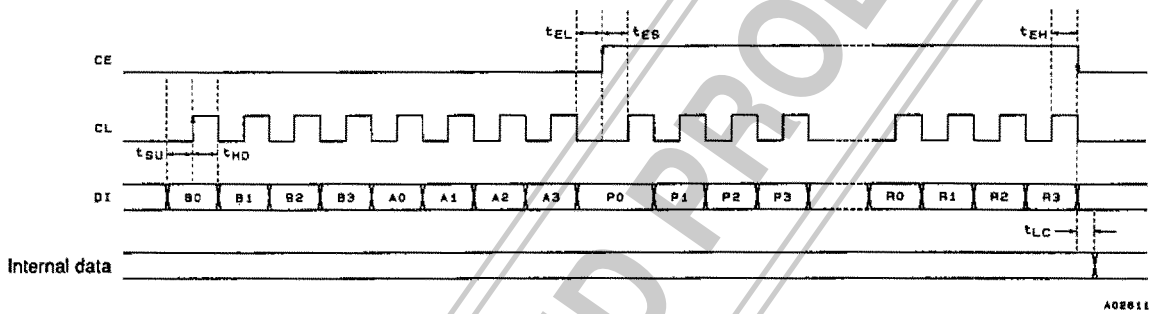

6. Serial Data Output (OUT)  $t_{SU}, t_{HD}, t_{EL}, t_{ES}, t_{EH} \geq 0.75 \mu s, t_{DC}, t_{DH} \leq 0.35 \mu s$

① CL: Normal high

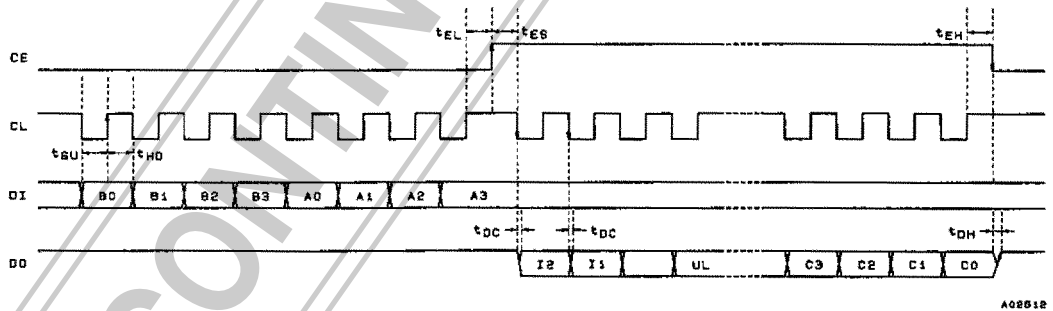

② CL: Normal low

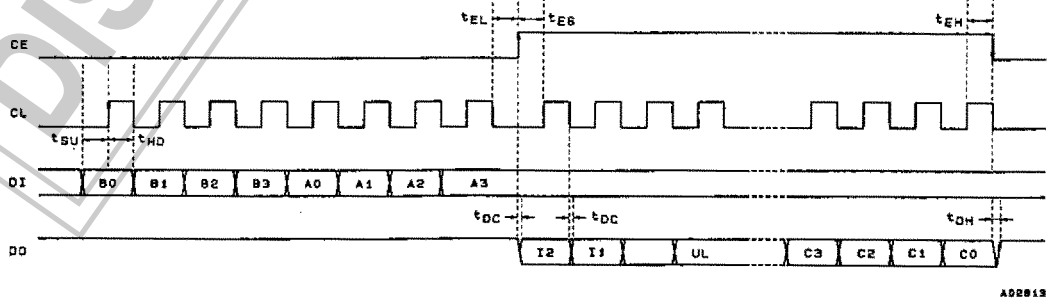

Note: Since the DO pin is an n-channel open-drain circuit, the time for the data to change ( $t_{DC}$  and  $t_{DH}$ ) will differ depending on the value of the pull-up resistor and printed circuit board capacitance.

7. Serial Data Timing

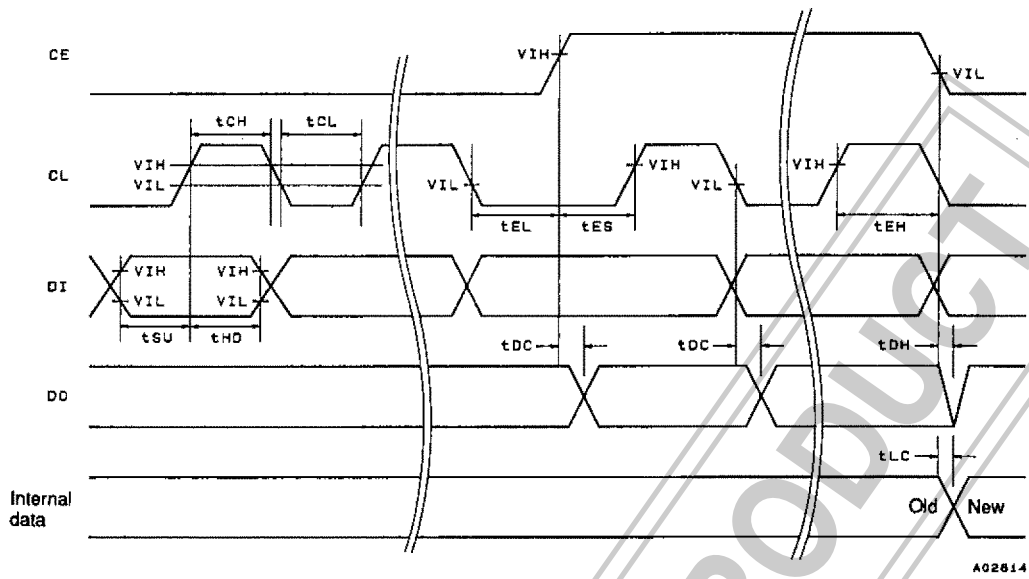

When stopped with CL low

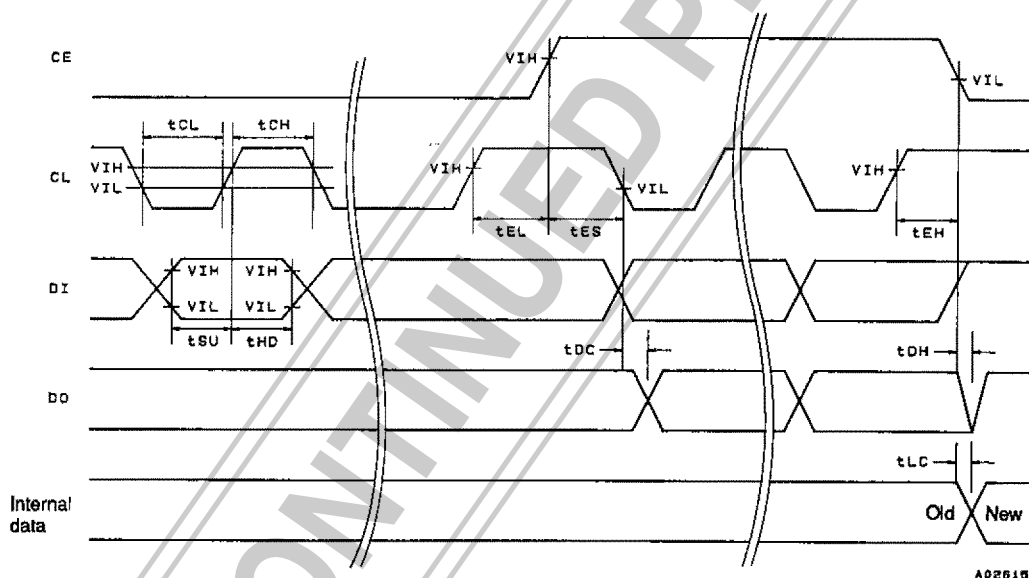

When stopped with CL high

Parameter	Symbol	Pins	Conditions	min	typ	max	Unit
Data setup time	$t_{SU}$	DI, CL		0.75			$\mu s$
Data hold time	$t_{HD}$	DI, CL		0.75			$\mu s$
Clock low-level time	$t_{CL}$	CL		0.75			$\mu s$
Clock high-level time	$t_{CH}$	CL		0.75			$\mu s$
CE wait time	$t_{EL}$	CE, CL		0.75			$\mu s$
CE setup time	$t_{ES}$	CE, CL		0.75			$\mu s$
CE hold time	$t_{EH}$	CE, CL		0.75			$\mu s$
Data latch change time	$t_{LC}$					0.75	$\mu s$
Data output time	$t_{DC}$	DO, CL	Differs depending on the value of the pull-up resistor and the printed circuit board capacitances.			0.35	$\mu s$
	$t_{DH}$	DO, CE					

Programmable Divider Structure

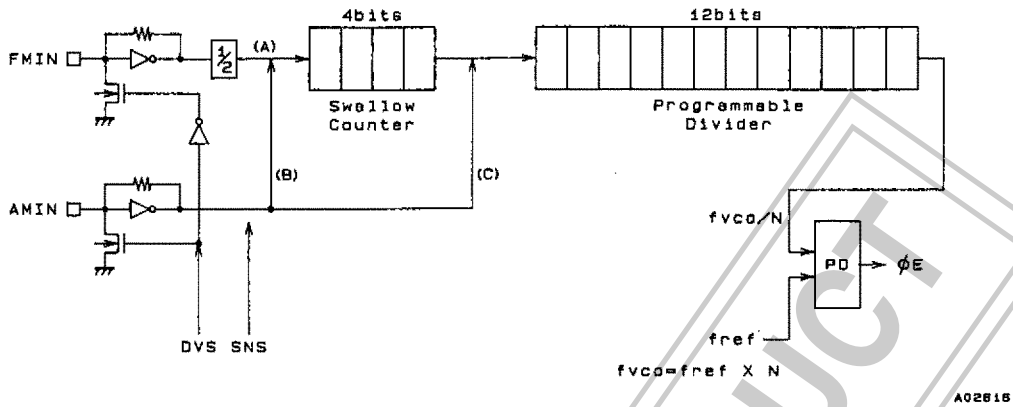

	DVS	SNS	Input pin	Set divisor	Actual divisor: N	Input frequency range (MHz)
A	1	*	FMIN	272 to 65535	Twice the set value	10 to 160
B	0	1	AMIN	272 to 65535	The set value	2 to 40
C	0	0	AMIN	4 to 4095	The set value	0.5 to 10

Note: \* Don't care.

1. Programmable Divider Calculation Examples

- FM, 50 kHz steps (DVS = 1, SNS = \*, FMIN selected)  
 FM RF = 90.0 MHz (IF = +10.7 MHz)  
 FM VCO = 100.7 MHz  
 PLL fref = 25 kHz (R0 to R1 = 1, R2 to R3 = 0)  
 $100.7 \text{ MHz (FM VCO)} + 25 \text{ kHz (fref)} + 2 \text{ (FMIN: divide-by-two prescaler)} = 2014 \rightarrow 07DE \text{ (HEX)}$

E				D				7				0																							
0	1	1	1	1	0	1	1	1	1	1	1	0	0	0	0	0	0	0	0	SNS	*	DVS	1	CTE		X8		R0	1	R1	1	R2	0	R3	0
P0	P1	P2	P3	P4	P5	P6	P7	P8	P9	P10	P11	P12	P13	P14	P15																				

A02617

- SW, 5 kHz steps (DVS = 0, SNS = 1, AMIN high-speed side selected)  
 SW RF = 21.75 MHz (IF = +450 kHz)  
 SW VCO = 22.20 MHz  
 PLL fref = 5 kHz (R0 = R2 = 0, R1 = R3 = 1)  
 $22.2 \text{ MHz (SW VCO)} + 5 \text{ kHz (fref)} = 4440 \rightarrow 1158 \text{ (HEX)}$

8				5				1				1																							
0	0	0	1	1	0	1	0	1	0	0	0	1	0	0	0	0	0	0	0	SNS	1	DVS	0	CTE		X8		R0	0	R1	1	R2	0	R3	1
P0	P1	P2	P3	P4	P5	P6	P7	P8	P9	P10	P11	P12	P13	P14	P15																				

A02618

- MW, 10 kHz steps (DVS = 0, SNS = 0, AMIN low-speed side selected)  
 MW RF = 1000 kHz (IF = +450 kHz)  
 MW VCO = 1450 kHz  
 PLL fref = 10 kHz (R0 to R2 = 0, R3 = 1)  
 $1450 \text{ kHz (MW VCO)} + 10 \text{ kHz (fref)} = 145 \rightarrow 091 \text{ (HEX)}$

1				8				0																											
*	*	*	*	1	0	0	0	1	0	0	0	0	0	0	0	0	0	0	0	SNS	0	DVS	0	CTE		X8		R0	0	R1	0	R2	0	R3	1
P0	P1	P2	P3	P4	P5	P6	P7	P8	P9	P10	P11	P12	P13	P14	P15																				

A02619

**IF Counter Structure**

The LC72132 IF counter is a 20-bit binary counter. The result, i.e., the counter's msb, can be read serially from the DO pin.

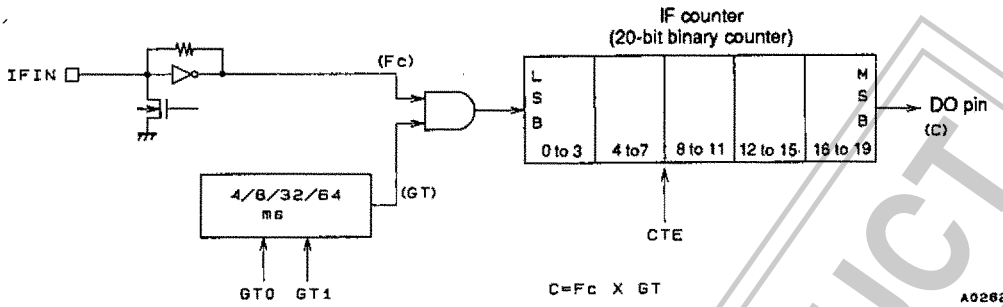

GT1	GT0	Measurement time	
		Measurement period (GT) (ms)	Wait time (t <sub>WU</sub> ) (ms)
0	0	4	3 to 4
0	1	8	3 to 4
1	0	32	7 to 8
1	1	64	7 to 8

The IF frequency (Fc) is measured by determining how many pulses were input to an IF counter in a specified measurement period, GT.

$$F_c = \frac{C}{GT} \quad (C = F_c \times GT) \quad C: \text{Count value (number of pulses)}$$

**1. IF Counter Frequency Calculation Examples**

- When the measurement period (GT) is 32 ms, the count (C) is 53980 hexadecimal (342400 decimal):  
IF frequency (Fc) = 342400 ÷ 32 ms = 10.7 MHz

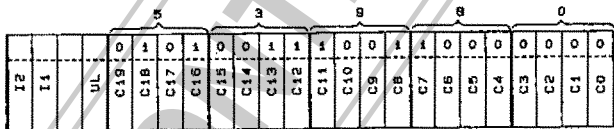

- When the measurement period (GT) is 8 ms, the count (C) is E10 hexadecimal (3600 decimal):  
IF frequency (Fc) = 3600 ÷ 8 ms = 450 kHz

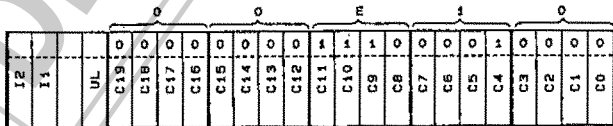



2. IF Counter Operation

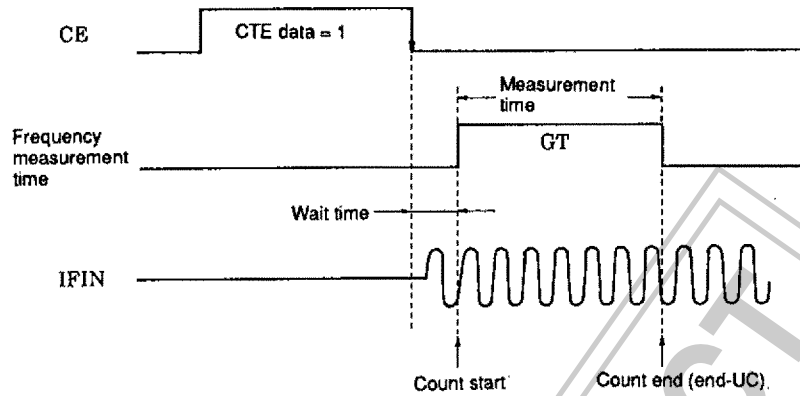

A02623

Before starting the IF count, the IF counter must be reset in advance by setting CTE in the serial data to 0.

The IF count is started by changing the CTE bit in the serial data from 0 to 1. The serial data is latched by the LC72132 when the CE pin is dropped from high to low. The IF signal must be supplied to the IFIN pin in the period between the point the CE pin goes low and the end of the wait time at the latest. Next, the value of the IF counter at the end of the measurement period must be read out during the period that CTE is 1. This is because the IF counter is reset when CTE is set to 0.

Note: When operating the IF counter, the control microprocessor must first check the state of the IF-IC SD (station detect) signal and only after determining that the SD signal is present turn on IF buffer output and execute an IF count operation. Autosearch techniques that use only the IF counter are not recommended, since it is possible for IF buffer leakage output to cause incorrect stops at points where there is no station.

IFIN minimum input sensitivity standard

IFS	f (MHz)		
	0.4 ≤ f < 0.5	0.5 ≤ f < 8	8 ≤ f ≤ 12
1: Normal mode	40 mVrms (0.1 to 3 mVrms)	40 mVrms	40 mVrms (1 to 10 mVrms)
0: Degradation mode	70 mVrms (10 to 15 mVrms)	70 mVrms	70 mVrms (30 to 40 mVrms)

Note: Value in parentheses are actual performance values presented as reference data.

DISCONTINUED PRODUCT

**Unlock Detection Timing**

1. Unlock Detection Determination Timing

Unlocked state detection is performed in the reference frequency ( $f_{ref}$ ) period (interval). Therefore, in principle, unlock determination requires a time longer than the period of the reference frequency. However, immediately after changing the divisor N (frequency) unlock detection must be performed after waiting at least two periods of the reference frequency.

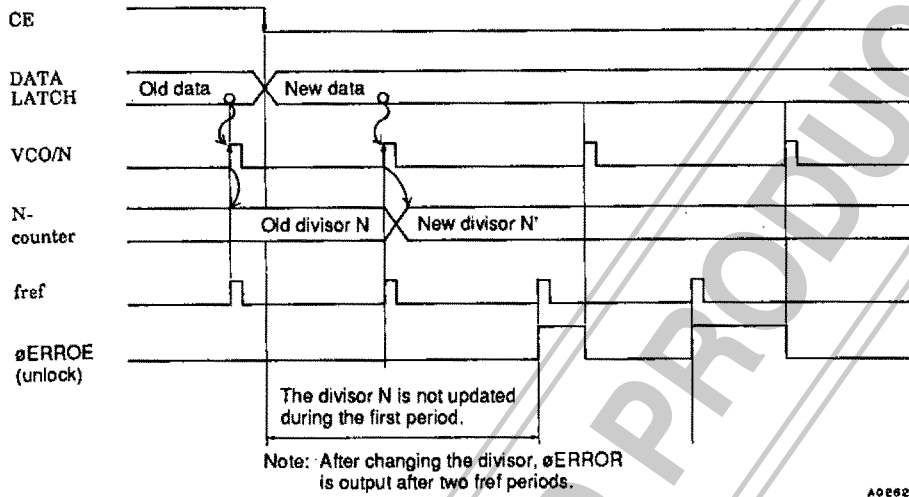

**Figure 1 Unlocked State Detection Timing**

For example, if  $f_{ref}$  is 1 kHz, i.e., the period is 1 ms, after changing the divisor N, the system must wait at least 2 ms before checking for the unlocked state.

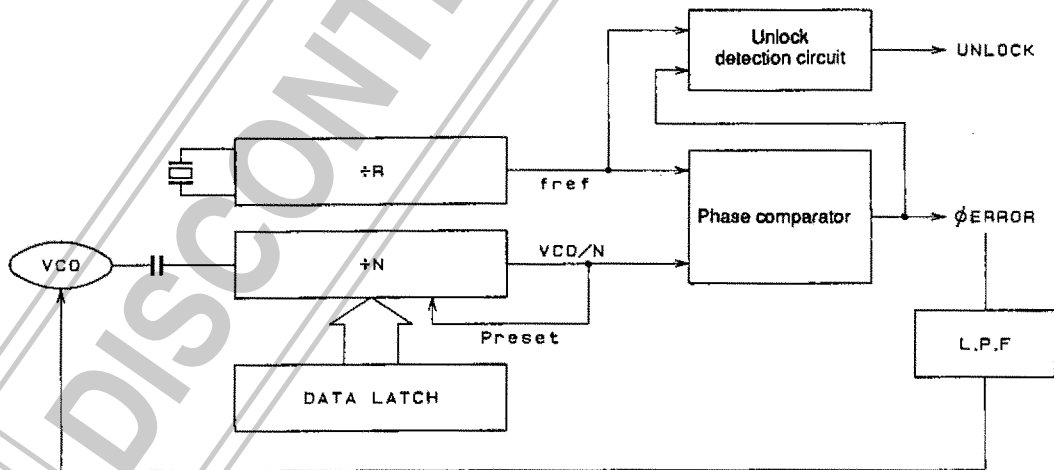

**Figure 2 Circuit Structure**

2. Unlock Detection Software

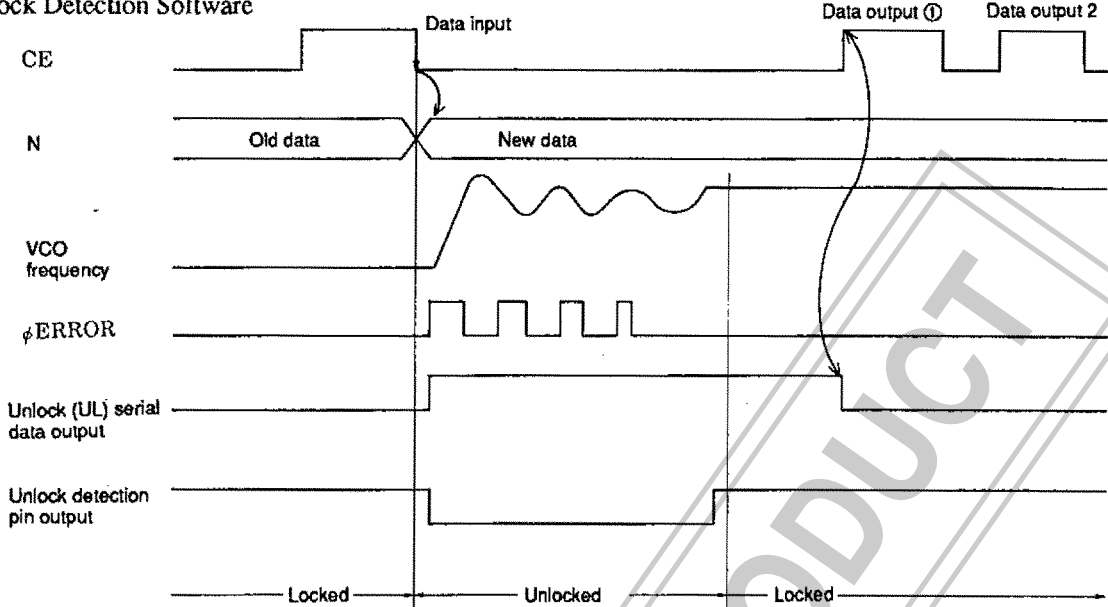
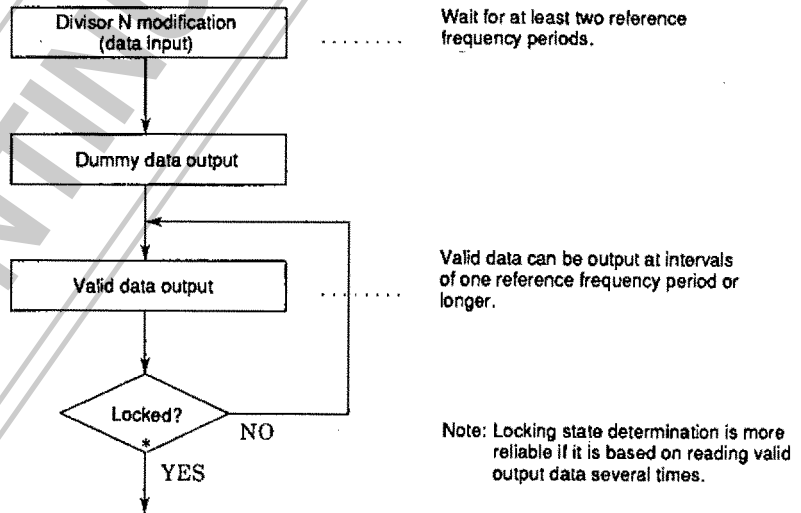

Figure 3

A02626

3. Unlocked State Data Output Using Serial Data Output

In the LC72132, once an unlocked state occurs, the unlocked state serial data (UL) will not be reset until a data input (or output) operation is performed. At the data output ① point in Figure 3, although the VCO frequency has stabilized (locked), since no data output has been performed since the divisor N was changed the unlocked state data remains in the unlocked state. As a result, even though the frequency has stabilized (locked), the system remains (from the standpoint of the data) in the unlocked state. Therefore, the unlocked state data acquired at data output ①, which occurs immediately after the divisor N was changed, should be treated as a dummy data output and ignored. The second data output (data output ②) and following outputs are valid data.



Locked State Determination Flowchart

4. Directly Outputting Unlocked State Data from the DO Pin (Set by the DO pin control data)

Since the locking state (high = locked, low = unlocked) is output directly from the DO pin, the dummy data processing described in section 3 above is not required. After changing the divisor N, the locking state can be checked after waiting at least two reference frequency periods.

## Clock Time Base Usage Notes

The pull-up resistor used on the clock time base output pin (BO1) should be at least 100 k $\Omega$ . Also, to prevent chattering we recommend using a Schmitt input at the controller (microprocessor) that receives this signal.

This is to prevent degrading the VCO C/N characteristics when a loop filter is formed using the built-in low-pass filter transistor. Since the clock time base output pin and the low-pass filter have a common ground internal to the IC, it is necessary to minimize the time base output pin current fluctuations and to suppress their influence on the low-pass filter.

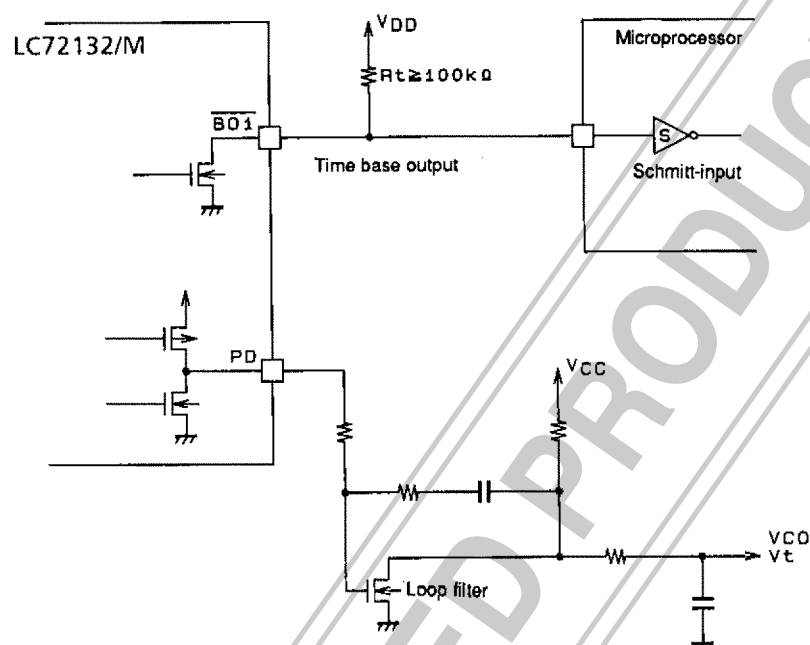

## Other Items

### 1. Notes on the Phase Comparator Dead Zone

DZ1	DZ0	Dead-zone mode	Charge pump	Dead zone
0	0	DZA	ON/ON	--0 s
0	1	DZB	ON/ON	-0 s
1	0	DZC	OFF/OFF	+0 s
1	1	DZD	OFF/OFF	+ +0 s

Since correction pulses are output from the charge pump even if the PLL is locked when the charge pump is in the ON/ON state, the loop can easily become unstable. This point requires special care when designing application circuits.

The following problems may occur in the ON/ON state.

- Side band generation due to reference frequency leakage
- Side band generation due to both the correction pulse envelope and low frequency leakage

Schemes in which a dead zone is present (OFF/OFF) have good loop stability, but have the problem that acquiring a high C/N ratio can be difficult. On the other hand, although it is easy to acquire a high C/N ratio with schemes in which there is no dead zone, it is difficult to achieve high loop stability. Therefore, it can be effective to select DZA or DZB, which have no dead zone, in applications which require an FM S/R ratio in excess of 90 to 100 dB, or in which an increased AM stereo pilot margin is desired. On the other hand, we recommend selecting DZC or DZD, which provide a dead zone, for applications which do not require such a high FM signal-to-noise ratio and in which either AM stereo is not used or an adequate AM stereo pilot margin can be achieved.

A03990

### Dead Zone

The phase comparator compares  $f_p$  to a reference frequency ( $f_r$ ) as shown in Figure 4. Although the characteristics of this circuit (see Figure 5) are such that the output voltage is proportional to the phase difference  $\phi$  (line A), a region (the dead zone) in which it is not possible to compare small phase differences occurs in actual ICs due to internal circuit delays and other factors (line B). A dead zone as small as possible is desirable for products that must provide a high S/N ratio.

However, since a larger dead zone makes this circuit easier to use, a larger dead zone is appropriate for popularly-priced products. This is because it is possible for RF signals to leak from the mixer to the VCO and modulate the VCO in popularly-priced products in the presence of strong RF inputs. When the dead zone is narrow, the circuit outputs correction pulses and this output can further modulate the VCO and generate beat frequencies with the RF signal.

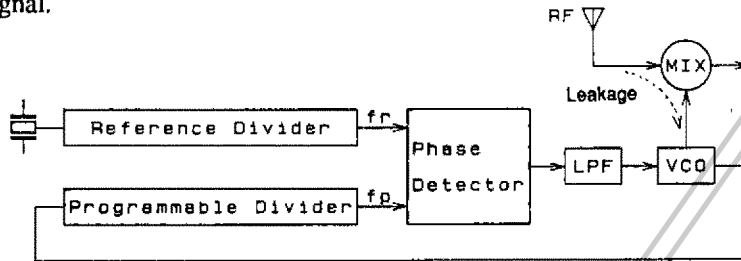

Figure 4

A02930

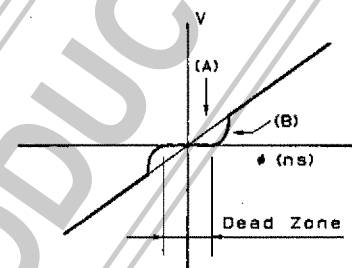

Figure 5

A02931

#### 2. Notes on the FMIN, AMIN, and IFIN Pins

Coupling capacitors must be placed as close as possible to their respective pin. A capacitance of about 100 pF is desirable. In particular, if a capacitance of 1000 pF or over is used for the IF pin, the time to reach the bias level will increase and incorrect counting may occur due to the relationship with the wait time.

#### 3. Notes on IF Counting → SD must be used in conjunction with the IF counting time

When using IF counting, always implement IF counting by having the microprocessor determine the presence of the IF-IC SD (station detect) signal and turn on the IF counter buffer only if the SD signal is present. Schemes in which auto-searches are performed with only IF counting are not recommended, since they can stop at points where there is no signal due to leakage output from the IF counter buffer.

#### 4. DO Pin Usage Techniques

In addition to data output mode times, the DO pin can also be used to check for IF counter count completion and for unlock detection output. Also, an input pin state can be output unchanged through the DO pin and input to the controller.

#### 5. Power Supply Pins

A capacitor of at least 2000 pF must be inserted between the power supply  $V_{DD}$  and  $V_{SS}$  pins for noise exclusion. This capacitor must be placed as close as possible to the  $V_{DD}$  and  $V_{SS}$  pins.

Pin States After the Power-ON Reset

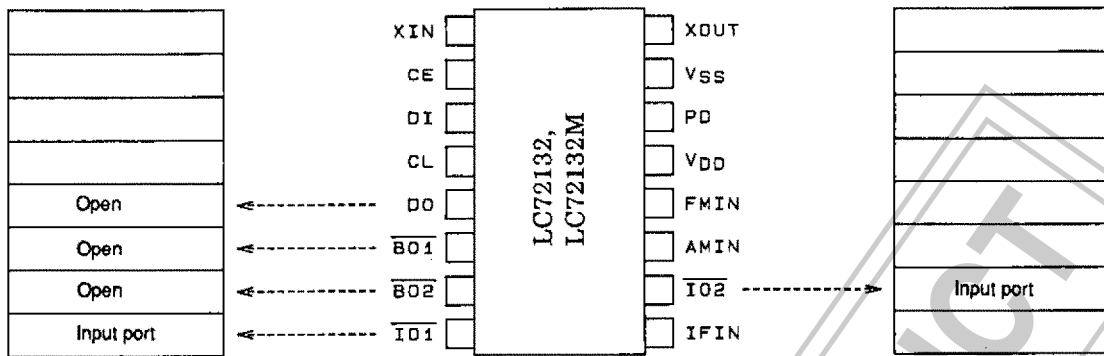

A03981

Application System Example

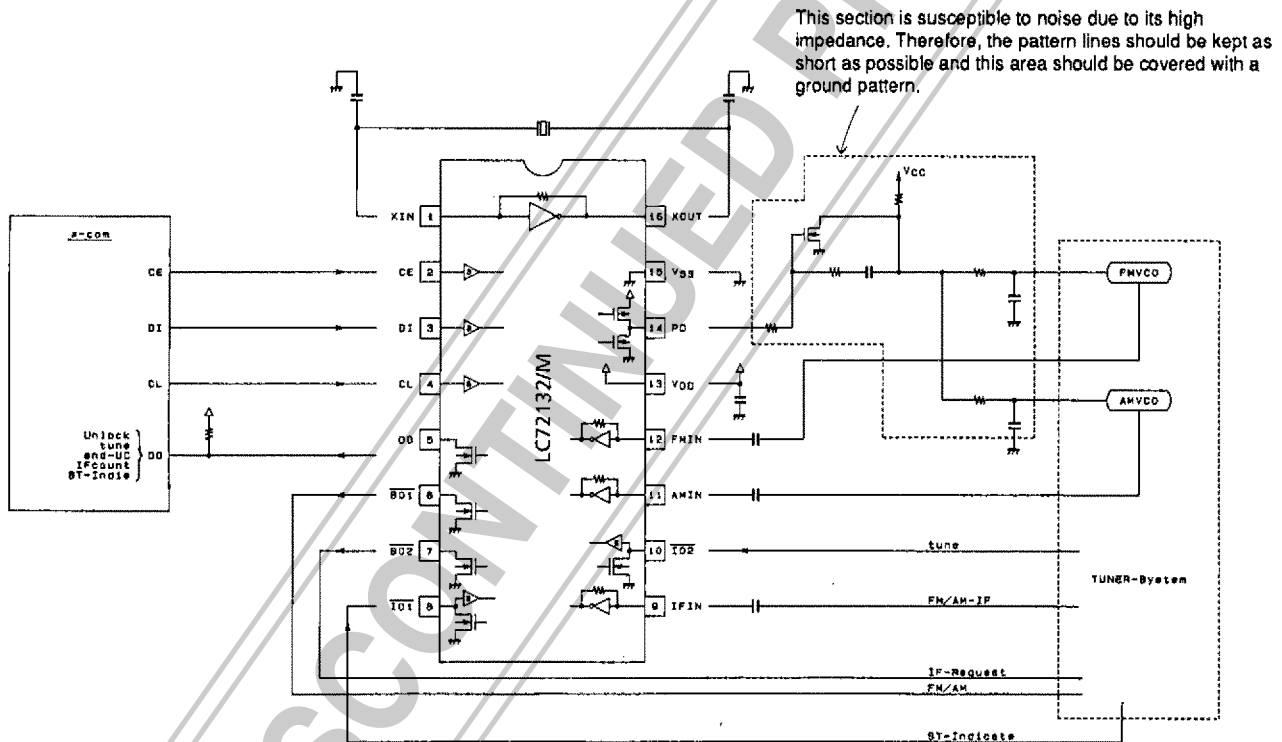

A03982

CONTINUED PRODUCT

- No products described or contained herein are intended for use in surgical implants, life-support systems, aerospace equipment, nuclear power control systems, vehicles, disaster/crime-prevention equipment and the like, the failure of which may directly or indirectly cause injury, death or property loss.
- Anyone purchasing any products described or contained herein for an above-mentioned use shall:
  - ① Accept full responsibility and indemnify and defend SANYO ELECTRIC CO., LTD., its affiliates, subsidiaries and distributors and all their officers and employees, jointly and severally, against any and all claims and litigation and all damages, cost and expenses associated with such use:
  - ② Not impose any responsibility for any fault or negligence which may be cited in any such claim or litigation on SANYO ELECTRIC CO., LTD., its affiliates, subsidiaries and distributors or any of their officers and employees jointly or severally.
- Information (including circuit diagrams and circuit parameters) herein is for example only; it is not guaranteed for volume production. SANYO believes information herein is accurate and reliable, but no guarantees are made or implied regarding its use or any infringements of intellectual property rights or other rights of third parties.

This catalog provides information as of October, 1995. Specifications and information herein are subject to change without notice.