

SANYO

No. 2642A

LC5734, 5734H**SINGLE-CHIP 4-BIT MICROCOMPUTER WITH
LCD DRIVERS FOR LOW-VOLTAGE,
LOW-POWER USE****General Description**

The LC5734/5734H are single-chip 4-bit microcomputers with LCD drivers. The features of the LC5734/5734H include low-voltage operation, low power dissipation, etc. The standby function, which can be used to stop/start the ceramic resonator oscillation, facilitates the low power dissipation of the system. The LC5734/5734H are ideally suited for use in timepiece/timer function-provided infrared remote control transmitter applications.

◆ Hardware Features

- ROM 2048 x 8 bits
- RAM 128 x 4 bits
- Instruction execution time
 - LC5734 17.6 μ s 2.0V to 6.0V (455kHz ceramic resonator OSC)
 - LC5734H 4.0 μ s 4.5V to 6.0V (2.0MHz ceramic resonator OSC)
- Current dissipation 3 μ A typ at 3V (Standby mode)
- Input/output pins Number of input pins: 8
 - Number of input/output pins: 8 (8 x 8 key matrix configuration available)
 - Number of dedicated output pins: 3 (carrier-only output pins: 2, alarm-only output pins: 1)
- LCD drivers

LCD display system	Number of drivable segments
Static	27 segments (max)
1/2bias-1/2duty	54 segments (max)
1/2bias-1/3duty	81 segments (max)

- Possible to use LCD drive output pins as output-only ports (mask option-selectable)
- Remote control carrier modulation control output On-chip 1/12 divider
 - Carrier frequency: 38kHz (455kHz ceramic resonator OSC, 1/3duty or 1/2duty selectable)
- System clock automatic selection at the standby mode (2 OSC circuits)
 - Ceramic resonator OSC circuit (455kHz) System clock/clock for remote control carrier
 - Crystal OSC circuit (32.768kHz) Time-base clock and system clock
- On-chip melody function 3 octaves
- On-chip segment PLA
 - The LCD driver output can be used to support any LCD panel layout without software processing.
- On-chip step-down circuit for LCD power supply
- Shipping style: FLP-64 (or chip)

◆ Software Features

- Powerful instruction set: 91 instructions
- Table read instruction (possible to set table in all ROM areas)
- 1-level subroutine nesting
- On-chip time-base 15-bit divider (delivers overflow signal every 32ms or 64ms/100ms/500ms when a 32.768kHz crystal OSC is used)
- HALT function
- Standby function Possible to stop ceramic resonator OSC with the execution of an instruction. (The time-base clock is changed to the system clock automatically.)

Application Development Support System

- Evaluation chip (LC5797) is available for application development and the dedicated equipment is available as the application development tools.
- SDS-410 system
Using the SDS-410, program development (editing, assembling) for microcomputer application circuit may be done. (IBM-PC or its equivalent also available)
- EVA-510 + TB-5734 + DCB-1 + Application evaluation board + LC5797 (**Rev. 2.0 or greater)
By connecting to the SDS-410, application development program correction and debugging may be done.
- TB-5734 + DCB-1 + Application evaluation board + LC5797
By using the EPROM (2732) with application development program data written in, mounting evaluation may be done.

Note) The application evaluation board is constructed by the user.
LEDs or LCDs may be used for display.

The EVA-510 is a modified version of the EVA-410 whose monitor ROM is replaced by the SCR-5734.

* The IBM-PC is an IBM-made product.

Note) Since the evaluation chip and the LC5734, 5734H differ in RAM capacity, be sure to check the RAM capacity when preparing or debugging programs.

LC5734: 128 x 4 bits
LC5797: 256 x 4 bits

Package Dimensions 3057-Q64AIC
(unit: mm)

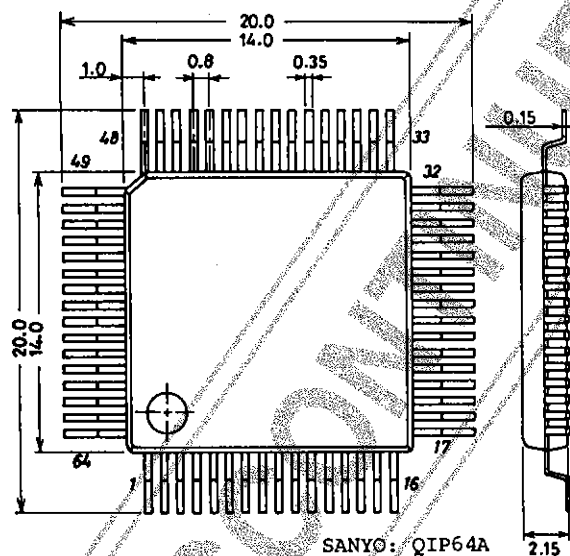

Package Dimensions 3026B-Q64BIC
(unit: mm)

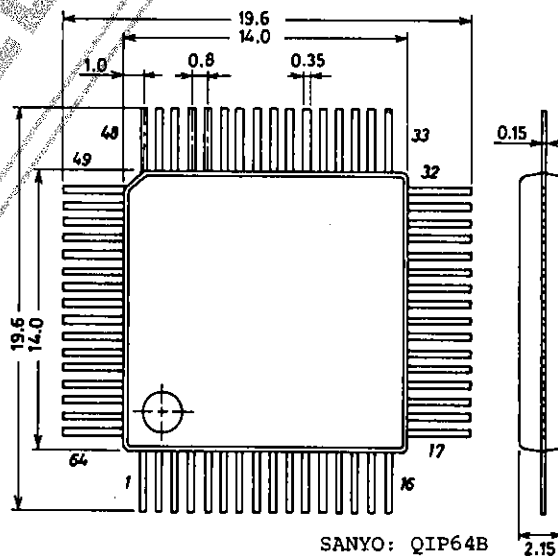

When mounting the QIP package on the board, do not dip it in solder.

Note) When developing programs, take care of the DPH value. The usable DPH values are 0 to 7. We will be free from any blame even if you use DPH=8 to FH to develop programs.

Pad Name and Coordinates

QIP64 Pin Assignment					QIP64 Pin Assignment				
	Pad No.	Pin Name	X (μm)	Y (μm)		Pad No.	Pin Name	X (μm)	Y (μm)
26	1	VDD	-300	2590	57	34	CUP1	45	-2590
27	2	S4	-485	2590	58	35	CUP2	255	-2590
28	3	S3	-710	2590	59	36	S2	460	-2590
29	4	M1	-1020	2590	60	37	S1	685	-2590
30	5	M2	-1245	2590	61	38	RES	915	-2590
31	6	M3	-1470	2590	62	39	OSCIN	1215	-2590
32	7	M4	-1700	2590	63	40	OSCOU	1440	-2590
	8	TEST	-1700	2355	64	41	TEST	1700	-2590
	9	TEST	-1700	2130	1	42	P00	1700	-2265
33	10	SEG14	-1700	1860	2	43	P01	1700	-1975
34	11	SEG15	-1700	1640	3	44	P02	1700	-1680
35	12	SEG16	-1700	1420	4	45	P03	1700	-1390
36	13	SEG17	-1700	1200	5	46	COM2	1700	-960
37	14	SEG18	-1700	980	6	47	SEG1	1700	-605
38	15	SEG19	-1700	760	7	48	SEG2	1700	-385
39	16	SEG20	-1700	540	8	49	SEG3	1700	-165
40	17	SEG21	-1700	320	9	50	SEG4	1700	55
41	18	SEG22	-1700	100	10	51	SEG5	1700	275
42	19	SEG23	-1700	-120	11	52	SEG6	1700	495
43	20	SEG24	-1700	-340	12	53	SEG7	1700	715
44	21	SEG25	-1700	-560	13	54	SEG8	1700	935
45	22	SEG26	-1700	-780	14	55	SEG9	1700	1160
46	23	SEG27	-1700	-1000	15	56	SEG10	1700	1380
47	24	COM1	-1700	-1180	16	57	SEG11	1700	1600
48	25	P13	-1700	-1405	17	58	SEG12	1700	2590
49	26	P12	-1700	-2590	18	59	SEG13	1455	2590
50	27	P11	-1470	-2590	19	60	COM3	1225	2590
51	28	P10	-1260	-2590	20	61	ALM1	1020	2590
52	29	CFOSC1	-1040	-2590	21	62	C-PORT2	810	2590
53	30	CFOSC2	-840	-2590	22	63	C-PORT1	615	2590
54	31	TEST	-630	-2590	23	64	Vss2	330	2590
55	32	T3	-405	-2590	24	65	Vss1	110	2590
56	33	32Hz	-180	-2590	25	66	BAK	-105	2590

• The values (X, Y) indicate the coordinates of each pad center with the center of the chip as the origin.

DISCONTINUED

Sample Application Circuit

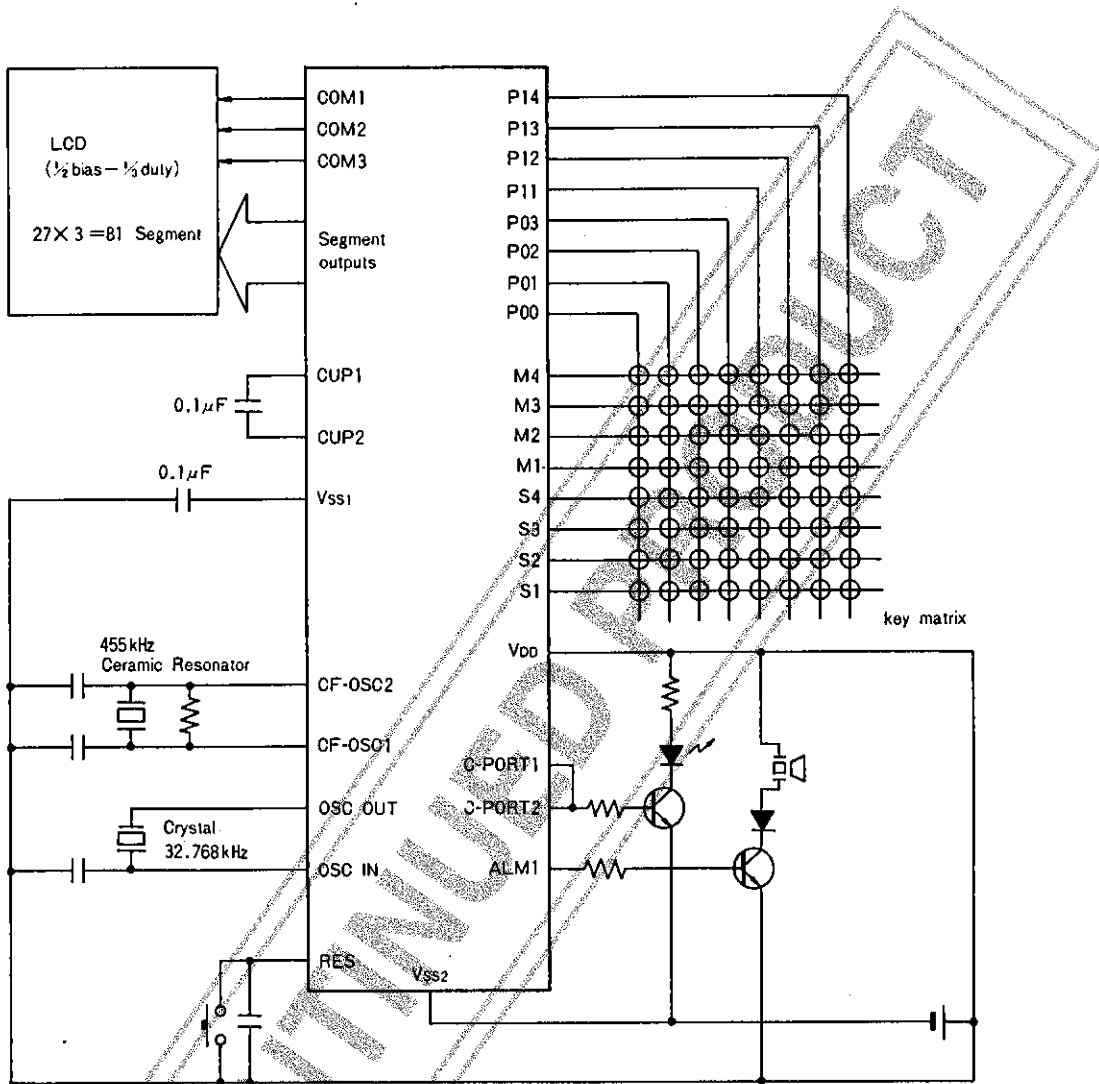

Notes for developing an LC5730 series microcomputer-used system
 The low current dissipation is a distinctive feature of the LC5730 series microcomputers. However, it is not easy to determine the total current to be dissipated in an LC5730 series microcomputer-used system by actual measurement when you develop a software, because much current flows in the peripherals of the evaluation tools.
 For a system which requires low current dissipation, check the current dissipation using an evaluation sample before mass-producing the system.

Pin Description

Pad No.	Pin Name	Input/Output	Circuit Configuration	Function
39	OSCIN	Input		<p>1) Crystal OSC mode A crystal is connected across OSCIN and OSCOUT for oscillation.</p> <p>2) RC OSC mode R (external resistance) is connected across OSCIN and OSCOUT and C (external capacitance) is connected across OSCIN and VDD for oscillation.</p>
40	OSCOUT	Output		
37 36 3 2	S1 S2 S3 S4	Input		<p>Input-only port LSI system is reset by applying VDD to S1 to S4 simultaneously.</p>
4 5 6 7	M1 M2 M3 M4	Input		<p>Input-only port.</p>
38	RES	Input		<p>Input pin for resetting LSI system.</p>
66	BAK			<p>(-) power supply pin for logic unit inside the LSI.</p>
61	ALM1	Output		<p>Output-only pin Used to deliver *4kHz, 2kHz, 1kHz modulation signal with the execution of an instruction. Also used to deliver non-modulation signal. Used to deliver melody signal of 3 octaves with the execution of an instruction.</p>
63 62	C-PORT1 C-PORT2	Output		<p>Output-only pins Delivers carrier for remote control transmission. Possible to select 38kHz or 57kHz (carrier frequency) by mask option.</p>
1	VDD			<p>(+) power supply pin</p>
64 65	VSS2 VSS1			<p>For EXT-V version, (-) power supply is applied to VSS2. Also used as LCD drive power supply. External parts are connected as shown below. Connection of external parts</p>

*4kHz, 2kHz, 1kHz: For 32.768kHz crystal OSC application, Proportional to OSC frequency.

LC5734, 5734H

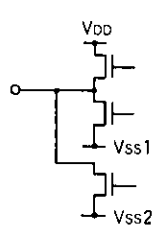
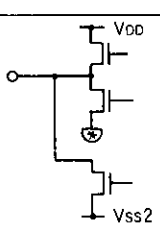
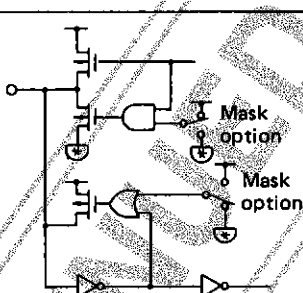
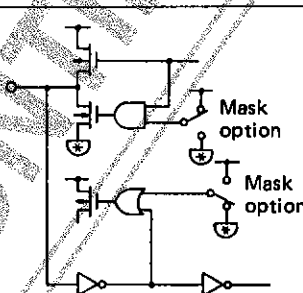
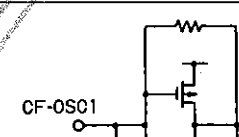
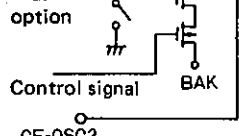
Pad No.	Pin Name	Input/Output	Circuit Configuration	Function																				
34 35	CUP1 CUP2			Pins for connecting voltage step-down capacitor																				
24 46 60	COM1 COM2 COM3	Output		<p>Output pins for LCD panel common plate The following pin is used in each case.</p> <table border="1"> <thead> <tr> <th></th> <th>Static</th> <th>1/2duty</th> <th>1/3duty</th> </tr> </thead> <tbody> <tr> <td>COM1</td> <td>○</td> <td>○</td> <td>○</td> </tr> <tr> <td>COM2</td> <td>—</td> <td>○</td> <td>○</td> </tr> <tr> <td>COM3</td> <td>—</td> <td>—</td> <td>○</td> </tr> <tr> <td>Alternating frequency</td> <td>32Hz</td> <td>32Hz</td> <td>43Hz</td> </tr> </tbody> </table> <p>(Alternating frequency is for 32.768kHz crystal OSC application.)</p>		Static	1/2duty	1/3duty	COM1	○	○	○	COM2	—	○	○	COM3	—	—	○	Alternating frequency	32Hz	32Hz	43Hz
	Static	1/2duty	1/3duty																					
COM1	○	○	○																					
COM2	—	○	○																					
COM3	—	—	○																					
Alternating frequency	32Hz	32Hz	43Hz																					
10 5 23 47 5 59	Segment driver	Output		Output pins for LCD panel segments Mask option permits SEG14 to SEG27 (pad No. 10 to 23) to be used as output ports.																				
33 32 41 8 9	32Hz T3 TEST	Test		Test pins (not used by user)																				
42 43 44 45	P-00 P-01 P-02 P-03	Input/Output		<ul style="list-style-type: none"> 4-bit input/output port Mask option can be used to select C-MOS output or P-ch open drain output. 																				
28 27 26 25	P-10 P-11 P-12 P-13	Input/Output		<ul style="list-style-type: none"> 4-bit input/output port Mask option can be used to select C-MOS output or P-ch open drain output. 																				
29	CF-OSC1	Input		Input pin used to provide OSC and also used for internal clock generation. When no ceramic resonator is used, this input pin is set at "L" level by mask option.																				
30	CF-OSC2	Output		Output pin used to provide OSC.																				

Note)  is connected to VSS2.

●EXT-V-Version 1-1 (Xtal OSC + CF OSC)

Absolute Maximum Ratings/Ta=25±2°C, VDD=0V

				Unit
Maximum Supply Voltage	VSS1		-7.0 to +0.3	V
	VSS2		-7.0 to +0.3	V
Maximum Input Voltage	VIN1	OSCIN, 32Hz, CF-OSC1	VSS2-0.3 to 0.3	V
	VIN2	S1-4, M1-4, TEST, RES, P00-03, P10-13	VSS2-0.3 to 0.3	V
Maximum Output Voltage	VOUT1	32Hz, CUP2, OSCOUT, CF-OSC2	VSS2-0.3 to 0.3	V
	VOUT2	SEGOUT, COM1, COM2, COM3, CUP1, ALM1 C-PORT1, C-PORT2, P00-03, P10-13	VSS2-0.3 to 0.3	V
Operating Temperature	Topr		-30 to +80	°C
Storage Temperature	Tstg		-40 to +125	°C

Allowable Operating Conditions/Ta=-30 to +80°C, VDD=0V

			min	typ	max	Unit
Supply Voltage	VSS1		-6.0		-1.30	V
	VSS2		-6.0		-2.0	V
Input "H"-Level Voltage	VIH1	S1-4, M1-4, P00-03, P10-13	0.3 X VSS2		0	V
Input "L"-Level Voltage	VIL1	S1-4, M1-4, P00-03, P10-13	VSS2		0.7 X VSS2	V
Input "H"-Level Voltage	VIH2	RES	0.25 X VSS2		0	V
Input "L"-Level Voltage	VIL2	RES	VSS2		0.75 X VSS2	V
Operating Frequency	fopg1	Crystal OSC1	32	32.768	33	kHz
	fopg2	Crystal OSC2	60	65.536	70	kHz
	fCF	CF OSC (Fig. 13) (Cycle time 16µs at CF=500kHz)	380	455	500	kHz

Electrical Characteristics/Ta=-30 to +80°C, VDD=0V

			min	typ	max	Unit
Input Resistance	RIN1A	VSS2=-2.9V, VIL=VSS2+0.4V, "L"-level hold tr., *1, Fig. 4	150	300	1000	kΩ
	RINTB	VSS2=-2.9V, "L"-level pull-in Tr., *1, Fig. 4	60	100	150	kΩ
	RIN2A	VSS2=-2.9V, VIH=-0.4V, "H"-level hold tr., *4, Fig. 4	200	600	2000	kΩ
	RIN3	VSS2=-2.9V, TEST, RES	10		300	kΩ
Output "H"-Level Voltage	VOH1	VSS2=-2.9V, IOH=-0.4µA, *2	-0.2			V
Output "L"-Level Voltage	VOL1	VSS2=-2.9V, IOL=0.4µA, *2			VSS2 +0.2	V
Output "H"-Level Voltage	VOH2	VSS2=-2.9V, IOH=-4µA, COM1, COM2, COM3	-0.2			V
Output "M"-Level Voltage	VOM	VSS2=-2.9V, IOH=-4µA, IOL=4µA, COM1, COM2, COM3	VSS2/2 -0.2		VSS2/2 +0.2	V
Output "L"-Level Voltage	VOL2	VSS2=-2.9V, IOL=4µA COM1, COM2, COM3			VSS2 +0.2	V

Continued on next page.

LC5734, 5734H

Continued from preceding page.

			min	typ	max	Unit
Output "H"-Level Voltage	VOH3	VSS2=-2.4V, IOH=-250μA, ALM1	-0.65			V
Output "L"-Level Voltage	VOL3	VSS2=-2.4V, IOL=250μA, ALM1			VSS2+0.65	V
Output Current (H) 1	IOH1	VSS2=-3.0V, VOH=-1.5V, C-PORT1		-12	-6	mA
Output Current (L) 1	IOL1	VSS2=-3.0V, VOL=VSS2+0.9V, C-PORT1	3	7		mA
Output Current (H) 2	IOH2	VSS2=-3.0V, VOH=-1.5V, C-PORT2		-12	-6	mA
Output Current (L) 2	IOL2	VSS2=-3.0V, VOL=VSS2+0.9V, C-PORT2	4	8		mA
Output Current (H) 3	IOH3	VSS2=-3.0V, VOH=-0.45V, *3			-45	μA
Output Current (L) 3	IOL3	VSS2=-3.0V, VOL=VSS2+0.45, *3	45			μA
Output Current (H) 4	IOH4	VSS2=-3.0V, VOH=-0.45V, *4			-450	μA
Output Current (L) 4	IOL4	VSS2=-3.0V, VOL=VSS2+0.45V, *4	450			μA
Output Voltage (halver)	VSS1	VSS2=-2.9V, C1=C2=0.1μF, fopg=32.768kHz, Fig. 5		-1.45	-1.35	V
Supply Current	IDD1	VSS2=-3.0V, 32.768kHz Xtal OSC, Ta≤50°C, HALT mode, C1=C2=0.1μA, Cg=20pF, CI≤25kΩ, CF stop, Fig. 5		3.0	15	μA
Supply Current	IDD2	VSS2=-3.0V, 65.536kHz Xtal OSC, Ta≤50°C, HALT mode, C1=C2=0.1μF (Cd=20pF), Cg=10pF, CI≤25kΩ, CF stop, Fig. 5		8.0	30	μA
Supply Current	IDD3	VSS2=-3.0V, 455kHz CF OSC, HALT mode, C1=C2=0.1μF, CCFI=CCFO=150pF, Rf=1MΩ, Xtal stop, Ta≤50°C, Fig. 10		80	300	μA
OSC Start Voltage 1	Vstt1	Cg=20pF, Ta=25°C	-2.3			V
OSC Hold Voltage 1	VHOLD1	32.768kHz Xtal OSC (CI≤25kΩ), Fig. 3			-2.0	V
OSC Start Time 1	tstt1	VSS2=-2.3V, Cd=Cg=20pF, Ta=25°C, 32.768kHz Xtal OSC (CI≤25kΩ), Fig. 3			10	s
OSC Start Voltage 2	Vstt2	Cg=10pF	-2.6			V
OSC Hold Voltage 2	VHOLD2	65.536kHz Xtal OSC (CI≤25kΩ), Fig. 3			-2.4	V
OSC Start Time 2	tstt2	VSS2=-2.6V, Cg=10pF, (Cd=20pF), Ta=25°C, 65.536kHz Xtal OSC (CI≤25kΩ), Fig. 3			10	s
OSC Start Voltage 3	Vstt3	CCFI=CCFO=150pF, 455kHz CF OSC, Ta=25°C, Rf=1MΩ, Fig. 11	-2.0			V
OSC Hold Voltage 3	VHOLD3	Ta=25°C, Rf=1MΩ, Fig. 11			-2.0	V
OSC Start Time 3	tstt3	CCFI=CCFO=150pF, VSS2=-2.0V, Ta=25°C, 455kHz CF OSC, Rf=1MΩ, Fig. 11			30	ms

LC5734, 5734H

● EXT-V Version 1-2 (RC OSC + CF OSC)

Absolute Maximum Ratings/ $T_a=25\pm 2^\circ\text{C}$, $V_{DD}=0\text{V}$

				Unit
Maximum Supply Voltage	VSS1		-7.0 to +0.3	V
	VSS2		-7.0 to +0.3	V
Maximum Input Voltage	VIN1	OSCIN, 32Hz, CF-OSC1	$V_{SS2}-0.3$ to 0.3	V
	VIN2	S1-4, M1-4, TEST, RES, P00-03, P10-13	$V_{SS2}-0.3$ to 0.3	V
Maximum Output Voltage	VOUT1	32Hz, CUP2, OSCOUT, CF-OSC2	$V_{SS2}-0.3$ to 0.3	V
	VOUT2	SEGOUT, COM1, COM2, COM3, CUP1, ALM1, C-PORT1, C-PORT2, P00-03, P10-13	$V_{SS2}-0.3$ to 0.3	V
Operating Temperature	Topr		-30 to +80	$^\circ\text{C}$
Storage Temperature	Tstg		-40 to +125	$^\circ\text{C}$

Allowable Operating Conditions/ $T_a=-30$ to $+70^\circ\text{C}$, $V_{DD}=0\text{V}$

			min	typ	max	Unit
Supply Voltage	VSS1		-6.0		-1.3	V
	VSS2		-6.0		-2.0	V
Input "H"-Level Voltage	VIH1	S1-4, M1-4, P00-03, P10-13	0.3 X		0	V
Input "L"-Level Voltage	VIL1	S1-4, M1-4, P00-03, P10-13		V_{SS2}	0.7 X V_{SS2}	V
Input "H"-Level Voltage	VIH2	RES	0.25 X		0	V
Input "L"-Level Voltage	VIL2	RES		V_{SS2}	0.75 X V_{SS2}	V
Operating Frequency	fopg1	RC OSC (Fig. 12)		32.768		kHz
	fCF	CF OSC (Fig. 13)	380	455	500	kHz

DISCONTINUED PRODUCT

LC5734, 5734H

Electrical Characteristics/ $T_a = -30$ to $+80^\circ\text{C}$, $V_{DD} = 0\text{V}$

			min	typ	max	Unit
Input Resistance	RIN1A	$V_{SS2} = -2.9\text{V}$, $V_{IL} = V_{SS2} + 0.4\text{V}$, "L"-level hold tr., *1, Fig. 4	150	300	1000	$k\Omega$
	RIN1B	$V_{SS2} = -2.9\text{V}$, "L"-level pull-in Tr., *1, Fig. 4	60	100	150	$k\Omega$
	RIN2A	$V_{SS2} = -2.9\text{V}$, $V_{IH} = -0.4\text{V}$, "H"-level hold tr., *4, Fig. 6	200	300	2000	$k\Omega$
	RIN3	$V_{SS2} = -2.9\text{V}$, TEST, RES	10		300	$k\Omega$
Output "H"-Level Voltage	VOH1	$V_{SS2} = -2.9\text{V}$, $I_{OH} = -0.4\mu\text{A}$, *2	-0.2			V
Output "L"-Level Voltage	VOL1	$V_{SS2} = -2.9\text{V}$, $I_{OL} = 0.4\mu\text{A}$, *2			$V_{SS2} + 0.2$	V
Output "H"-Level Voltage	VOH2	$V_{SS2} = -2.9\text{V}$, $I_{OH} = -4\mu\text{A}$, COM1, COM2, COM3	-0.2			V
Output "M"-Level Voltage	VOM	$V_{SS2} = -2.9\text{V}$, $I_{OH} = -4\mu\text{A}$, $I_{OL} = 4\mu\text{A}$, COM1, COM2, COM3	$V_{SS2}/2 - 0.2$		$V_{SS2}/2 + 0.2$	V
Output "L"-Level Voltage	VOL2	$V_{SS2} = -2.9\text{V}$, $I_{OL} = 4\mu\text{A}$ COM1, COM2, COM3			$V_{SS2} + 0.2$	V
Output "H"-Level Voltage	VOH3	$V_{SS2} = -2.4\text{V}$, $I_{OH} = -250\mu\text{A}$, ALM1	-0.65			V
Output "L"-Level Voltage	VOL3	$V_{SS2} = -2.4\text{V}$, $I_{OL} = 250\mu\text{A}$, ALM1			$V_{SS2} + 0.65$	V
Output Current (H) 1	I _{OH1}	$V_{SS2} = -3.0\text{V}$, $V_{OH} = -1.5\text{V}$, C-PORT1		-12	-6	mA
Output Current (L) 1	I _{OL1}	$V_{SS2} = -3.0\text{V}$, $V_{OL} = V_{SS2} + 0.9\text{V}$, C-PORT1	4	8		mA
Output Current (H) 2	I _{OH2}	$V_{SS2} = -3.0\text{V}$, $V_{OH} = -1.5\text{V}$, C-PORT2		-12	-6	mA
Output Current (L) 2	I _{OL2}	$V_{SS2} = -3.0\text{V}$, $V_{OL} = V_{SS2} + 0.9\text{V}$, C-PORT2	4	8		mA
Output Current (H) 3	I _{OH3}	$V_{SS2} = -3.0\text{V}$, $V_{OH} = -0.45\text{V}$, *3			-45	μA
Output Current (L) 3	I _{OL3}	$V_{SS2} = -3.0\text{V}$, $V_{OL} = V_{SS2} + 0.45\text{V}$, *3	45			μA
Output Current (H) 4	I _{OH4}	$V_{SS2} = -3.0\text{V}$, $V_{OH} = -0.45\text{V}$, *4			-450	μA
Output Current (L) 4	I _{OL4}	$V_{SS2} = -3.0\text{V}$, $V_{OL} = V_{SS2} + 0.45\text{V}$, *4	450			μA
Output Voltage (halver)	V _{SS1}	$V_{SS2} = -2.9\text{V}$, $R_{ext} = 470k\Omega$, $C_{ext} = 30pF$, $C_1 = C_2 = 0.1\mu F$, Fig. 9			-1.35	V
Supply Current 1	I _{DD1}	$V_{SS2} = -3.0\text{V}$, $R_{ext} = 470k\Omega$, $C_{ext} = 30pF$, $C_1 = C_2 = 0.1\mu F$, CF stop, $T_a \leq 50^\circ\text{C}$, Fig. 9		40	150	μA
Supply Current 2	I _{DD2}	$V_{SS2} = -3.0\text{V}$, 455kHz CF OSC, $C_1 = C_2 = 0.1\mu F$, CR OSC stop, $T_a \leq 50^\circ\text{C}$, Fig. 10		80	300	μA
OSC Start Voltage	V _{stt}	455kHz CF OSC,	-2.0			V
OSC Stop Voltage	V _{hold}	$C_{CFI} = C_{CFO} = 150pF$, wait time 1 sec, $R_f = 1M\Omega$, Fig. 11			-2.0	V
OSC Start Time	t _{stt}	455kHz CF OSC, $V_{SS2} = -2.0\text{V}$ $C_{CFI} = C_{CFO} = 150pF$ $R_f = 1M\Omega$, Fig. 11			30	ms

*1 S1, S2, S3, S4, M1, M2, M3, M4

*2 LCD driver output pins of SEGOUT1 to 13 and SEGOUT14 to 27

*3 Output pins (used as output port) of SEGOUT14 to 27

*4 P-00, P-01, P-02, P-03, P-10, P-11, P-12, P-13

LC5734, 5734H

• LC5734H Specifications 2-1 (Xtal OSC + CF OSC)

Absolute Maximum Ratings/ $T_a=25\pm 2^\circ\text{C}$, $V_{DD}=0\text{V}$

				Unit
Maximum Supply Voltage	VSS1		-7.0 to +0.3	V
	VSS2		-7.0 to +0.3	V
Maximum Input Voltage	VIN1	OSCIN, 32Hz, CF-OSC1	VSS2-0.3 to 0.3	V
	VIN2	S1-4, M1-4, TEST, RES, P00-03, P10-13	VSS2-0.3 to 0.3	V
Maximum Output Voltage	VOUT1	32Hz, CUP2, OSCOUT, CF-OSC2	VSS2-0.3 to 0.3	V
	VOUT2	SEGOUT, COM1, COM2, COM3, CUP1, ALM1, C-PORT1, C-PORT2, P00-03, P10-13	VSS2-0.3 to 0.3	V
Operating Temperature	Topr		-30 to +80	°C
Storage Temperature	Tstg		-40 to +125	°C

Allowable Operating Conditions/ $T_a=-30$ to $+80^\circ\text{C}$; $V_{DD}=0\text{V}$

			min	typ	max	Unit
Supply Voltage	VSS1		-6.0		-2.2	V
	VSS2		-6.0		-4.5	V
Input "H"-Level Voltage	VIH1	S1-4, M1-4, P00-03, P10-13	0.3 X VSS2		0	V
Input "L"-Level Voltage	VIL1	S1-4, M1-4, P00-03, P10-13	VSS2		0.7 X VSS2	V
Input "H"-Level Voltage	VIH2	RES	0.25 X VSS2		0	V
Input "L"-Level Voltage	VIL2	RES	VSS2		0.75 X VSS2	V
Operating Frequency	fopg1	Crystal OSC1	32	32.768	33	kHz
	fopg2	Crystal OSC2	60	65.536	70	kHz
	fCF	CF OSC (Fig. 10), (Cycle time 4 μ s at CF=2000kHz)	380		2000	kHz

Electrical Characteristics/ $T_a=-30$ to $+80^\circ\text{C}$, $V_{DD}=0\text{V}$

			min	typ	max	Unit
Input Resistance	RIN1A	VSS2=-5.0V, VIL=VSS2+0.4V, "L"-level hold tr., *1, Fig. 4	70	200	600	k Ω
	RIN1B	VSS2=-5.0V, "L"-level pull-in Tr., *1, Fig. 4	60	100	150	k Ω
	RIN2A	VSS2=-5.0V, VIH=-0.4V, "H"-level hold tr., *4, Fig. 6	100	400	1000	k Ω
	RIN3	VSS2=-5.0V, TEST, RES	10		300	k Ω
Output "H"-Level Voltage	VOH1	VSS2=-5.0V, IOH=-0.4 μ A, *2	-0.2			V
Output "L"-Level Voltage	VOL1	VSS2=-5.0V, IOL=0.4 μ A, *2			VSS2 +0.2	V
Output "H"-Level Voltage	VOH2	VSS2=-5.0V, IOH=-4 μ A, COM1, COM2, COM3	-0.2			V
Output "M"-Level Voltage	VOM	VSS2=-5.0V, IOH=-4 μ A, IOL=4 μ A, COM1, COM2, COM3	VSS2/2 -0.2		VSS2/2 +0.2	V
Output "L"-Level Voltage	VOL2	VSS2=-5.0V, IOL=4 μ A, COM1, COM2, COM3			VSS2 +0.2	V

Continued on next page.

Continued from preceding page.

			min	typ	max	Unit
Output "H" Level Voltage	VOH3	VSS2=-5.0V, IOH=-250µA, ALM1	-0.65			V
Output "L" Level Voltage	VOL3	VSS2=-5.0V, IOL=250µA, ALM1			VSS2 +0.65	V
Output Current (H) 1	IOH1	VSS2=-5.0V, VOH=-2.5V, C-PORT1		-20	-10	mA
Output Current (L) 1	IOL1	VSS2=-5.0V, VOL=VSS2+0.9V, C-PORT1	3	7		mA
Output Current (H) 2	IOH2	VSS2=-5.0V, VOH=-2.5V, C-PORT2		-20	-10	mA
Output Current (L) 2	IOL2	VSS2=-5.0V, VOL=VSS2+0.9V, C-PORT2	4	8		mA
Output Current (H) 3	IOH3	VSS2=-5.0V, VOH=-0.75V, *3			-75	µA
Output Current (L) 3	IOL3	VSS2=-5.0V, VOL=VSS2+0.75V, *3	75			µA
Output Current (H) 4	IOH4	VSS2=-5.0V, VOH=-0.75V, *4			-750	µA
Output Current (L) 4	IOL4	VSS2=-5.0V, VOL=VSS2+0.75V, *4	750			µA
Output Voltage (halver)	VSS1	VSS2=-5.0V, C1=C2=0.1µF, fopg=32.768kHz, Fig. 5			-2.4	V
Supply Current	IDD1	VSS2=-5.0V, 32.768kHz, Xtal OSC, HALT mode, C1=C2=0.1µF, Cg=20pF, CI ≤ 25kΩ, CF stop, Ta ≤ 50°C, Fig. 5		8.0	50	µA
Supply Current	IDD2	VSS2=-5.0V, 65.536kHz Xtal OSC, HALT mode, C1=C2=0.1µA (Cd=20pF), Cg=10pF, CI ≤ 25kΩ, CF stop, Ta ≤ 50°C, Fig. 5		20	100	µA
Supply Current	IDD3	VSS2=-5.0V, 455kHz CF OSC, HALT mode, C1=C2=0.1µF, CCF1=CCFO=150pF, Rf=1MΩ, Ta ≤ 50°C, Fig. 1		300	400	µA
Supply Current	IDD4	VSS2=-5.0V, 2000kHz CF OSC, HALT mode, C1=C2=0.1µF, CCF1=CCFO=33pF, Xtal stop, Rf=1MΩ, Ta ≤ 50°C, Fig. 10		350	500	µA
OSC Start Voltage 1	Vstt1	Cg=20pF, 32.768kHz Xtal OSC, (CI ≤ 25kΩ), Fig. 3	-2.3			V
OSC Hold Voltage 1	VHOLD1				-2.0	V
OSC Start Time 1	tsst1	VSS2=-2.3V, Cg=20pF, 32.768kHz Xtal OSC, (CI ≤ 25kΩ), Fig. 3			10	s
OSC Start Voltage 2	Vstt2	Cg=10pF, 65.536kHz Xtal OSC (Cd=20pF), (CI ≤ 25kΩ), Fig. 3	-2.6			V
OSC Hold Voltage 2	VHOLD2				-2.4	V
OSC Start Time 2	tsst2	VSS2=-2.6V, Cg=10pF, (Cd=20pF) 65.536kHz Xtal OSC, (CI ≤ 25kΩ), Fig. 3			10	s
OSC Start Voltage 3	Vstt3	Rf=1MΩ, wait time 1 sec, CCF1=CCFO=150pF, 455kHz CF OSC, Fig. 11	-2.0			V
OSC Hold Voltage 3	VHOLD3				-2.0	V
OSC Start Time 3	tsst3	VSS2=-4.5V, CCF1=CCFO=150pF, Rf=1MΩ, 455kHz CF OSC, Fig. 11			30	ms

LC5734, 5734H

● LC5734H Specifications 2-2 (RC OSC + CF OSC)

Absolute Maximum Ratings/ $T_a=25\pm 2^\circ\text{C}$, $V_{DD}=0\text{V}$

				Unit
Maximum Supply Voltage	VSS1		-7.0 to +0.3	V
	VSS2		-7.0 to +0.3	V
Maximum Input Voltage	VIN1	OSCIN, 32Hz, CF-OSC1	$V_{SS2}-0.3$ to 0.3	V
	VIN2	S1-4, M1-4, TEST, RES, P00-03, P10-13	$V_{SS2}-0.3$ to 0.3	V
Maximum Output Voltage	VOUT1	32Hz, CUP2, OSCOUT, CF-OSC2	$V_{SS2}-0.3$ to 0.3	V
	VOUT2	SEGOUT, COM1, COM2, COM3, CUP1, ALM1, C-PORT1, C-PORT2, P00-03, P10-13	$V_{SS2}-0.3$ to 0.3	V
Operating Temperature	Topr		-30 to +80	$^\circ\text{C}$
Storage Temperature	Tstg		-40 to +125	$^\circ\text{C}$

Allowable Operating Conditions/ $T_a=-30$ to $+80^\circ\text{C}$, $V_{DD}=0\text{V}$

			min	typ	max	Unit
Supply Voltage	VSS1		-6.0		-2.2	V
	VSS2		-6.0		-4.5	V
Input "H"-Level Voltage	VIH1	S1-4, M1-4, P00-03, P10-13	0.3 X		0	V
Input "L"-Level Voltage	VIL1	S1-4, M1-4, P00-03, P10-13	V_{SS2}		0.7 X	V
Input "H"-Level Voltage	VIH2	RES	0.25 X		0	V
Input "L"-Level Voltage	VIL2	RES	V_{SS2}		0.75 X	V
Operating Frequency	fopg1	RC OSC (Fig. 12)		32.768		kHz
	fCF	CF OSC (Fig. 13) (Cycle time 4 μs at fCF=2000kHz)	380		2000	kHz

DISCONTINUED PRODUCT

LC5734, 5734H

Electrical Characteristics/ $T_a = -30$ to $+80^\circ\text{C}$, $V_{DD} = 0\text{V}$

			min	typ	max	
Input Resistance	RIN1A	$V_{SS2} = -5.0\text{V}$, $V_{IL} = V_{SS2} + 0.4\text{V}$, "L"-level hold tr., *1, Fig. 4	150	300	1000	$\text{k}\Omega$
	RIN1B	$V_{SS2} = -5.0\text{V}$, "L"-level pull-in Tr., *1, Fig. 4	60	100	150	$\text{k}\Omega$
	RIN2A	$V_{SS2} = -5.0\text{V}$, $V_{IH} = -0.4\text{V}$, "H"-level hold tr., *4, Fig. 6	200	300	2000	$\text{k}\Omega$
	RIN3	$V_{SS2} = -5.0\text{V}$, TEST, RES	10		300	$\text{k}\Omega$
Output "H"-Level Voltage	VOH1	$V_{SS2} = -5.0\text{V}$, $I_{OH} = -0.4\mu\text{A}$, *2	-0.2			V
Output "L"-Level Voltage	VOL1	$V_{SS2} = -5.0\text{V}$, $I_{OL} = 0.4\mu\text{A}$, *2			$V_{SS2} + 0.2$	V
Output "H"-Level Voltage	VOH2	$V_{SS2} = -5.0\text{V}$, $I_{OH} = -4\mu\text{A}$, COM1, COM2, COM3	-0.2			V
Output "M"-Level Voltage	VOM	$V_{SS2} = -5.0\text{V}$, $I_{OH} = -4\mu\text{A}$, $I_{OL} = 4\mu\text{A}$, COM1, COM2, COM3	$V_{SS2}/2 - 0.2$		$V_{SS2}/2 + 0.2$	V
Output "L"-Level Voltage	VOL2	$V_{SS2} = -5.0\text{V}$, $I_{OL} = 4\mu\text{A}$ COM1, COM2, COM3			$V_{SS2} + 0.2$	V
Output "H"-Level Voltage	VOH3	$V_{SS2} = -5.0\text{V}$, $I_{OH} = -250\mu\text{A}$, ALM1	-0.65			V
Output "L"-Level Voltage	VOL3	$V_{SS2} = -5.0\text{V}$, $I_{OL} = 250\mu\text{A}$, ALM1			$V_{SS2} + 0.65$	V
Output Current (H) 1	I_{OH1}	$V_{SS2} = -5.0\text{V}$, $V_{OH} = -2.5\text{V}$, C-PORT1		-20	-10	mA
Output Current (L) 1	I_{OL1}	$V_{SS2} = -5.0\text{V}$, $V_{OL} = V_{SS2} - 0.9\text{V}$, C-PORT1	3	7		mA
Output Current (H) 2	I_{OH2}	$V_{SS2} = -5.0\text{V}$, $V_{OH} = -2.5\text{V}$, C-PORT2		-20	-10	mA
Output Current (L) 2	I_{OL2}	$V_{SS2} = -5.0\text{V}$, $V_{OL} = V_{SS2} + 0.9\text{V}$, C-PORT2	4	8		mA
Output Current (H) 3	I_{OH3}	$V_{SS2} = -5.0\text{V}$, $V_{OH} = -0.75\text{V}$, *3			-75	μA
Output Current (L) 3	I_{OL3}	$V_{SS2} = -5.0\text{V}$, $V_{OL} = V_{SS2} + 0.75\text{V}$, *3	75			μA
Output Current (H) 4	I_{OH4}	$V_{SS2} = -5.0\text{V}$, $V_{OH} = -0.75\text{V}$, *4			-750	μA
Output Current (L) 4	I_{OL4}	$V_{SS2} = -5.0\text{V}$, $V_{OL} = V_{SS2} + 0.75\text{V}$, *4	750			μA
Output Voltage (halver)	VSS1	$V_{SS2} = -5.0\text{V}$, Rest=470k Ω , Cest=30pF, C1=C2=0.1 μF , Fig. 9			-2.4	V
Supply Current	I_{DD1}	$V_{SS2} = -5.0\text{V}$, fRC=32kHz, C1=C2=0.1 μF , HALT mode, $T_a \leq 50^\circ\text{C}$, CF stop, Fig. 9		200	400	μA
Supply Current	I_{DD2}	$V_{SS2} = -5.0\text{V}$, 455kHz CF OSC, C1=C2=0.1 μF , RC OSC stop, CCFI=CCFO=150pF, Rf=1M Ω , HALT mode, $T_a \leq 50^\circ\text{C}$, Fig 10		300	400	μA
Supply Current	I_{DD3}	$V_{SS2} = -5.0\text{V}$, 2MHz CF OSC, RC OSC stop, CCFI=CCFO=33pF, Rf=1M Ω , HALT mode, $T_a \leq 50^\circ\text{C}$, Fig. 10		350	500	μA
OSC Start Voltage	Vstt	455kHz CF, wait time 1sec,	-2.0			V
OSC Stop Voltage	VHOLD1	CCFI=CCFO=150pF, Rf=1M Ω , Fig. 11			-2.0	V
OSC Start Time	tstt	$V_{SS2} = -4.5\text{V}$, 455kHz CF OSC, CCFI=CCFO=150pF, Rf=1M Ω , Fig. 11			30	ms

*1 S1, S2, S3, S4, M1, M2, M3, M4

*2 LCD driver output pins of SEGOUT1 to 13 and SEGOUT14 to 27

*3 Output pins (used as output port) of SEGOUT14 to 27

*4 P-00, P-01, P-02, P-10, P-11, P-12, P-13

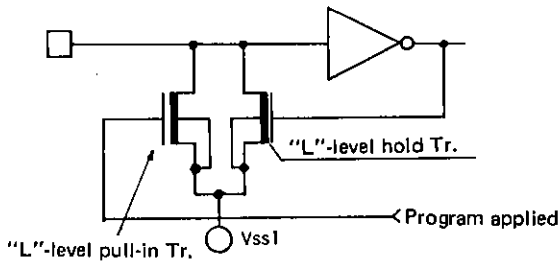

Fig. 1 Input configuration of S1-4, M1-4

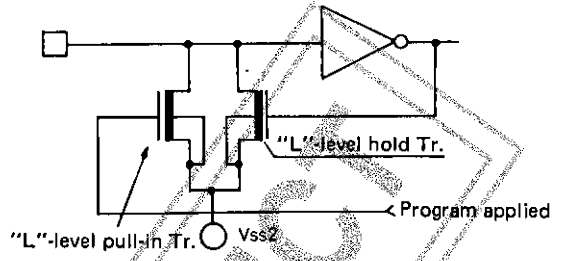

Fig. 4 Input configuration of S1-4, M1-4

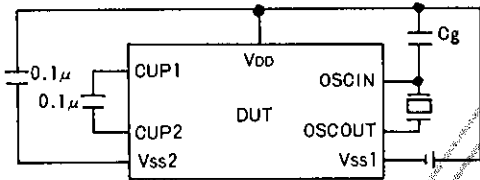

Fig. 2 Current dissipation, output voltage test circuit.

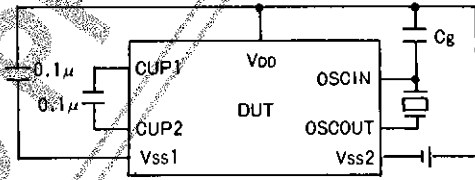

Fig. 5 Current dissipation, output voltage test circuit.

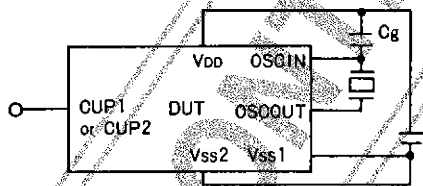

Fig. 3 Oscillation start voltage, oscillation start time, frequency stability, oscillation hold voltage test circuit.

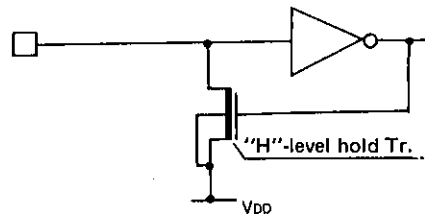

Fig. 6 Input configuration of P00-03, P10-13

Unit (capacitance: F)

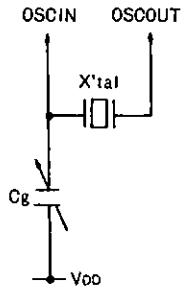

Fig. 7 Crystal oscillator

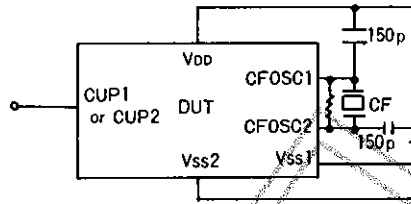

Fig. 11 Oscillation start voltage, oscillation start time, frequency stability, oscillation hold voltage test circuit.

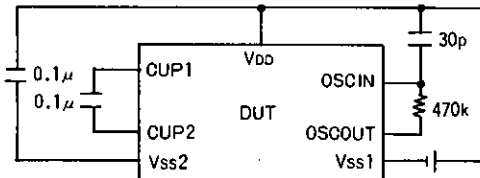

Fig. 8 Current dissipation, output voltage test circuit.

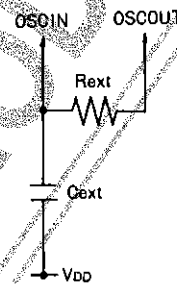

Fig. 12 RC oscillation

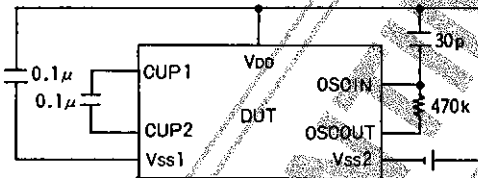

Fig. 9 Current dissipation, output voltage test circuit.

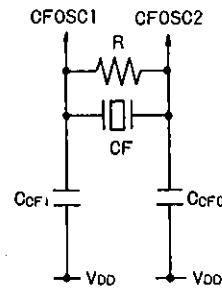

Fig. 13 CF oscillation

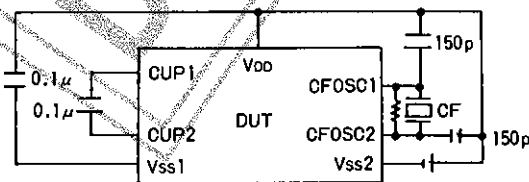

Fig. 10 Current dissipation, output voltage test circuit.

Unit (resistance: Ω, capacitance: F)

LC5734, 5734H

LC5734 Instruction Map

Instruction set: 91 instructions

..... 1-cycle instruction 1-byte instruction
 2-cycle instruction 2-byte instruction

LOWER UPPER	0	1	2	3	4	5	6	7	8	9	A	B	C	D	E	F
0	HALT	TAAT	TWRT	TMEL	CSP	CST	RC5	SC5	JMP X							
1	JMP*	PAGE	MTR	RTS	MPCL	MPCM	MPCH	IN	ASR0	ASR1	ASL0	ASL1	SDPL	SDPH	EDPL	EDPH
2	MVI X															
3	LDI X															
4	BAZ X								BAB0 X							
5	BANZ X								BAB1 X							
6	BCNH X								BAB2 X							
7	BCH X								BAB3 X							
8	ADC	SBC	ADD	SUB	ADN	AND	EOR	OR	ADC*	SBC*	ADD*	SUB*	ADN*	AND*	EOR*	OR*
9	ADCI	SBCI	ADDI	SUBI	ADNI	ANDI	EORI	ORI	INC	DEC	IDPL	DDPL	IDPH	DDPH	ISP	DSP
A	JSR X								IPM	LDA	LSP	LHLT	L500	STA	SSP	IPS
B	MDPL X															
C	MDPH X															
D	SIC X															
E	MSP X															
F	RCF	SCF	NOP	NOP	SPDR X				RBAK	SBAK	SAS X	CSEC	OUT	LDPL	LDPH	NOP

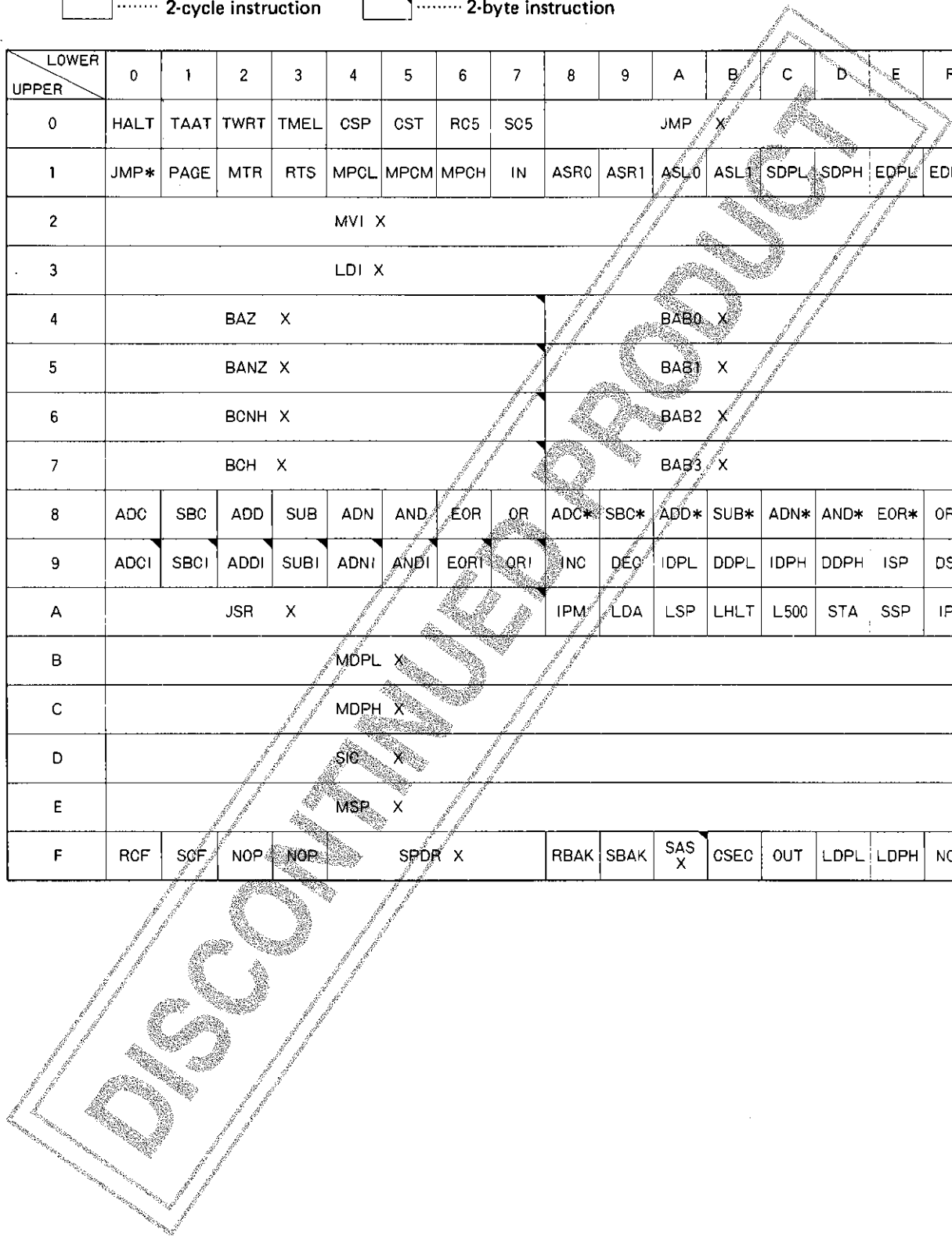

Instruction Set of LC5734

Summary of LC5734 Instructions

Symbol Meaning

AC	: Accumulator	M(DP)	: Memory addressed by DP	(), []	: Contents
ACn	: Accumulator bit	[P()]	: Contents of port ()	←	: Transfer direction, result
DP	: Data pointer	PC	: Program counter	∧	: AND
EDP	: Save data pointer	STACK	: Stack register	∨	: OR
SP	: Strobe pointer	[M(DP)]	: Contents of memory addressed by DP	⊕	: Exclusive OR
CF	: Carry flag	STSn	: Status register		
TREG	: Temporary register	CSTF	: Chrono start flag		
SCFn	: Start condition flag n	PDF	: Pull-down flag		
HEFn	: Halt release enable flag n	PAGE	: Page latch		
L(SP)	: LCD latch specified by SP	PGX	: Current Page		
M	: Memory				

DISCONTINUED PRODUCT

Instruction	Mnemonic	Instruction code								Bytes	Cycles	Function	Description	Status flag to be affected
		D7	D6	D5	D4	D3	D2	D1	D0					
		Accumulator manipulation instructions, memory manipulation instructions												
RCF	Reset CF	1	1	1	1	0	0	0	0	1	1	CF ← 0	The CF is reset.	CF
SCF	Set CF	1	1	1	1	0	0	0	1	1	1	CF ← 1	The CF is set.	CF
ASR0	Shift Right AC & MSB=0	0	0	0	1	1	0	0	0	1	1	AC _n ← AC _{n+1} AC ₃ ← 0	The AC contents are shifted right and 0 is loaded to the MSB.	
ASR1	Shift Right AC & MSB=1	0	0	0	1	1	0	0	1	1	1	AC _n ← AC _{n+1} AC ₃ ← 1	The AC contents are shifted right and 1 is loaded to the MSB.	
ASL0	Shift Left AC & LSB=0	0	0	0	1	1	0	1	0	1	1	AC _n ← AC _{n-1} AC ₀ ← 0	The AC contents are shifted left and 0 is loaded to the LSB.	
ASL1	Shift Left AC & LSB=1	0	0	0	1	1	0	1	1	1	1	AC _n ← AC _{n-1} AC ₀ ← 1	The AC contents are shifted left and 1 is loaded to the LSB.	
INC	Increment M(DP)	1	0	0	1	1	0	0	0	1	1	M(DP), AC ← M(DP)+1	The memory M(DP) contents are incremented (+1) and are loaded to the M(DP) and AC.	
DEC	Decrement M(DP)	1	0	0	1	1	0	0	1	1	1	M(DP), AC ← M(DP)-1	The memory M(DP) contents are decremented (-1) and are loaded to the M(DP) and AC.	
TAAT	Read table data from program ROM	0	0	0	0	0	0	0	1	1	2	AC, TREG ← ROM (PGX, AC, M(DP))	The contents of the ROM on current page addressed by the PC whose low-order 8 bits are replaced with the contents of the AC and M(DP) are loaded to the AC and TREG.	
MTR	Store TREG to M(DP)	0	0	0	1	0	0	1	0	1	1	M(DP) ← TREG	The TREG contents are stored to the M(DP).	
Operation instructions														
ADC	Add M(DP) to AC with CF	1	0	0	0	0	0	0	0	1	1	AC ← (AC)+[M(DP)] ←(CF)	The AC, memory [M(DP)], CF contents are binary-added and the result is loaded to the AC.	CF
ADC*	Add M(DP) to AC with CF	1	0	0	0	1	0	0	0	1	1	AC, M(DP) ← (AC)+[M(DP)] ←(CF)	The AC, memory [M(DP)], CF contents are binary-added and the result is loaded to the AC and M(DP).	CF
SBC	Subtract M(DP) from AC with CF	1	0	0	0	0	0	0	1	1	1	AC ← (AC)+[M(DP)] ←(CF)	The memory M(DP) contents are binary-subtracted from the AC, CF contents and the result is loaded to the AC.	CF
SBC*	Subtract M(DP) from AC with CF	1	0	0	0	1	0	0	1	1	1	AC, M(DP) ← (AC)+[M(DP)] ←(CF)	The memory M(DP) contents are binary-subtracted from the AC, CF contents and the result is loaded to the AC and M(DP).	CF
ADD	Add M(DP) to AC	1	0	0	0	0	0	1	0	1	1	AC ← (AC)+[M(DP)]	The AC, memory [M(DP)] contents are binary-added and the result is loaded to the AC.	CF
ADD*	Add M(DP) to AC	1	0	0	0	1	0	1	0	1	1	AC, M(DP) ← (AC)+[M(DP)]	The AC, memory [M(DP)] contents are binary-added and the result is loaded to the AC and M(DP).	CF
SUB	Subtract M(DP) from AC	1	0	0	0	0	0	1	1	1	1	AC ← AC+[M(DP)] +1	The memory M(DP) contents are binary-subtracted from the AC contents and the result is loaded to the AC.	CF
SUB*	Subtract M(DP) from AC	1	0	0	0	1	0	1	1	1	1	AC, M(DP) ← (AC)+[M(DP)] +1	The memory M(DP) contents are binary-subtracted from the AC contents and the result is loaded to the AC and M(DP).	CF
ADN	Add M(DP) to AC	1	0	0	0	0	1	0	0	1	1	AC ← (AC)+[M(DP)]	The AC, memory [M(DP)] contents are binary-added and the result is loaded to the AC.	
ADN*	Add M(DP) to AC	1	0	0	0	1	1	0	0	1	1	AC, M(DP) ← (AC)+[M(DP)]	The AC, memory [M(DP)] contents are binary-added and the result is loaded to the AC and M(DP).	
AND	AND M(DP) to AC	1	0	0	0	0	1	0	1	1	1	AC ← (AC)∧[M(DP)]	The AC contents and memory [M(DP)] contents are ANDed and the result is loaded to the AC.	
AND*	AND M(DP) to AC	1	0	0	0	1	1	0	1	1	1	AC, M(DP) ← (AC)∧[M(DP)]	The AC contents and memory [M(DP)] contents are ANDed and the result is loaded to the AC and M(DP).	
EOR	Exclusive OR M(DP) to AC	1	0	0	0	0	1	1	0	1	1	AC ← (AC)⊕[M(DP)]	The AC contents and memory [M(DP)] contents are Exclusive-ORed and the result is loaded to the AC.	
EOR*	Exclusive OR M(DP) to AC	1	0	0	0	1	1	1	0	1	1	AC, M(DP) ← (AC)⊕[M(DP)]	The AC contents and memory [M(DP)] contents are Exclusive-ORed and the result is loaded to the AC and M(DP).	

Continued on next page.

Continued from preceding page.

Instruction	Mnemonic		Instruction code								Bytes	Cycles	Function	Description	Status flag to be affected	
			D7	D6	D5	D4	D3	D2	D1	D0						
Operation instructions	OR	OR M(DR) to AC	1	0	0	0	0	1	1	1	1	1	AC ← (AC)∨[M(DP)]	The AC contents and memory [M(DP)] contents are ORed and the result is loaded to the AC.		
	OR*	OR M(DR) to AC	1	0	0	0	1	1	1	1	1	1	AC, M(DP) ← (AC)∨[M(DP)]	The AC contents and memory [M(DP)] contents are ORed and the result is loaded to the AC and M(DP).		
	ADCI X	Add Immediate data to ACC with CF	1	0	0	1	0	0	0	0	0	2	2	AC ← (AC)+X+(CF)	The AC, CF contents and Immediate data X are binary-added and the result is loaded to the AC.	CF
	SBCI X	Subtract Immediate data from AC with CF	1	0	0	1	0	0	0	0	1	2	2	AC ← (AC)+X+(CF)	Immediate data X is binary-subtracted from the AC contents and the result is loaded to the AC.	CF
	ADDI X	Add Immediate data to AC	1	0	0	1	0	0	1	0	0	2	2	AC ← (AC)+X	The AC contents and Immediate data X are binary-added and the result is loaded to the AC.	CF
	SUBI X	Subtract Immediate data from AC	1	0	0	1	0	0	1	1	0	2	2	AC ← (AC)+X+1	Immediate data X is binary-subtracted from the AC contents and the result is loaded to the AC.	CF
	ADNI X	Add Immediate data to AC	1	0	0	1	0	1	0	0	0	2	2	AC ← (AC)+X	The AC contents and Immediate data X are binary-added and the result is loaded to the AC.	
	ANDI X	AND Immediate data to AC	1	0	0	1	0	1	0	1	0	2	2	AC ← (AC)∧X	The AC contents and Immediate data X are ANDed and the result is loaded to the AC.	
	EORI X	Exclusive OR Immediate data to AC	1	0	0	1	0	1	1	0	0	2	2	AC ← (AC)∨X	The AC contents and Immediate data X are Exclusive-ORed and the result is loaded to the AC.	
	ORI X	OR Immediate data to AC	1	0	0	1	0	1	1	1	0	2	2	AC ← (AC)∨X	The AC contents and Immediate data X are ORed and the result is loaded to the AC.	
Data pointer manipulation instructions	SDPL	Store AC to DPL	0	0	0	1	1	1	0	0	1	1	1	DPL ← (AC)	The AC contents are loaded to the DPL.	
	SDPH	Store AC to DPH	0	0	0	1	1	1	0	1	1	1	1	DPH ← (AC)	The AC contents are loaded to the DPH.	
	EDPL	Exchange DPL with EDPL	0	0	0	1	1	1	1	0	1	1	1	(DPL) ↔ (EDPL)	The DPL contents and EDPL contents are exchanged.	
	EDPH	Exchange DPH with EDPH	0	0	0	1	1	1	1	1	1	1	1	(DPH) ↔ (EDPH)	The DPH contents and EDPH contents are exchanged.	
	IDPL	Increment DPL	1	0	0	1	1	0	1	0	1	1	1	DPL ← (DPL)+1	The DPL contents are incremented +1.	
	DDPL	Decrement DPL	1	0	0	1	1	0	1	1	1	1	1	DPL ← (DPL)-1	The DPL contents are decremented -1.	
	IDPH	Increment DPH	1	0	0	1	1	1	0	0	1	1	1	DPH ← (DPH)+1	The DPH contents are incremented +1.	
	DDPH	Decrement DPH	1	0	0	1	1	1	0	1	1	1	1	DPH ← (DPH)-1	The DPH contents are decremented -1.	
	LDPL	Load AC from DPL	1	1	1	1	1	1	0	1	1	1	1	AC ← (DPL)	The DPL contents are loaded to the AC.	
	LDPH	Load AC from DPH	1	1	1	1	1	1	1	0	1	1	1	AC ← (DPH)	The DPH contents are loaded to the AC.	
Flag manipulation instructions	MDPL X	Move Immediate data to DPL	1	0	1	1	X3	X2	X1	X0	1	1	DPL ← X	Immediate data X is loaded to the DPL.		
	MDPH X	Move Immediate data to DPH	1	1	0	0	X3	X2	X1	X0	1	1	DPH ← X	Immediate data X is loaded to the DPH.		
	LHLT	Load Halt Release Flag	1	0	1	0	1	0	1	1	1	1	1	AC ← (STS2) STS2 ← 0	The STS2 contents are transferred to the AC and then the STS2 is reset.	SCF1-4
	L500	Load AC from STS1	1	0	1	0	1	1	0	0	0	1	1	AC ← (STS1) SCF0 ← 0	The STS1 contents are transferred to the AC and then the SCF0 is reset.	SCF0
	CSP	Chrono Stop	0	0	0	0	0	1	0	0	0	1	1	CSTF ← 0	The CSTF is reset.	CSTF
	CST	Chrono Start	0	0	0	0	0	1	0	1	1	1	1	CSTF ← 1	The CSTF is set.	CSTF
RC5	Reset HEF0	0	0	0	0	0	1	1	0	0	1	1	HEF0 ← 0	The HEF0 is reset so that the halt mode release by an overflow from the predivider is inhibited.	HEF0	
SC5	Set HEF0	0	0	0	0	0	1	1	1	1	1	1	HEF0 ← 1	The HEF0 is set so that an overflow signal from the predivider releases the halt mode.	HEF0	

Continued on next page.

Continued from preceding page.

Instruction	Mnemonic	Instruction code								Bytes	Cycles	Function	Description	Status flag to be affected	
		D7	D6	D5	D4	D3	D2	D1	D0						
Store pointer manipulation instructions	ISP	Increment SP	1	0	0	1	1	1	1	0	1	1	SP ← (SP)+1	The SP contents are incremented +1.	
	DSP	Decrement SP	1	0	0	1	1	1	1	1	1	1	SP ← (SP)-1	The SP contents are decremented -1.	
	LSP	Load AC from SP	1	0	1	0	1	0	1	0	1	1	AC ← (SP)	The SP contents are loaded to the AC.	
	SSP	Store AC to SP	1	0	1	0	1	1	1	0	1	1	SP ← (AC)	The AC contents are loaded to the SP.	
	MSP X	Move Immediate data to SP	1	1	1	0	X ₃	X ₂	X ₁	X ₀	1	1	SP ← X	Immediate data X is loaded to the SP.	
Load/store instructions	LDA	Load AC from [M(DP)]	1	0	1	0	1	0	0	1	1	1	AC ← [M(DP)]	The memory [M(DP)] contents are loaded to the AC.	
	STA	Store AC to [M(DP)]	1	0	1	0	1	1	0	1	1	1	M(DP) ← (AC)	The AC contents are loaded to the memory M(DP).	
	MVIX	Move Immediate data to M(DP)	0	0	1	0	X ₃	X ₂	X ₁	X ₀	1	1	M(DP) ← X	Immediate data X is loaded to the memory M(DP).	
	LDIX	Load AC with Immediate data	0	0	1	1	X ₃	X ₂	X ₁	X ₀	1	1	AC ← X	Immediate data X is loaded to the AC.	
CPU control instructions	HALT	HALT	0	0	0	0	0	0	0	0	1	1	The operation of CPU is stopped. The following condition causes the halt mode to be released. ● The halt release condition specified by the SIC and SC5 instruction is met.		
	SIC X	Set/Reset HALT Release Enable Flag	1	1	0	1	X ₃	X ₂	X ₁	X ₀	1	1	Operation		HEF 1 to 4
													X ₀ =1	The HEF1 is set so that the signal from the predivider releases the halt mode.	
													X ₁ =1	The HEF2 is set so that the rising of signal at input port S releases the halt mode.	
													X ₂ =1	The HEF3 is set so that the rising of signal at input port M releases the halt mode.	
X ₃ =1	The HEF4 is set so that the 1/10-second pulse releases the halt mode.														
NOP	No Operation	1	1	1	1	1	1	1	1	1	1				
RBAK	Reset Back-up Mode	1	1	1	1	1	0	0	0	1	1	BCF - 0	The backup mode is released.		
SBAK	Set Back-up Mode	1	1	1	1	1	0	0	1	1	1	BCF - 1	When powered from Li battery, VSS2 is applied to the logic unit. When powered from Ag. Li battery, EXT-V, the OSC circuit is doubled in inverter size.		
Input/output instructions	IPS	Input Port-S to AC	1	0	1	0	1	1	1	1	1	1	AC ← [P(S)]	The input data at input port S is loaded to the AC.	
	IPM	Input Port-M to AC	1	0	1	0	1	0	0	0	1	1	AC ← [P(M)]	The input data at input port M is loaded to the AC.	
	SAS X	Set Alarm Sound	1	1	1	1	1	0	1	0	2	2	Waveforms specified by X ₇ to X ₀ are delivered at the ALM1.		
X ₇ - X ₀													X ₇	X ₆	X ₅
			Control contents	Alarm tone/melody select signal	Octave Control	Musical Scal Control									

Alarm OFF at X₃ to X₀ = 1

Continued on next page.

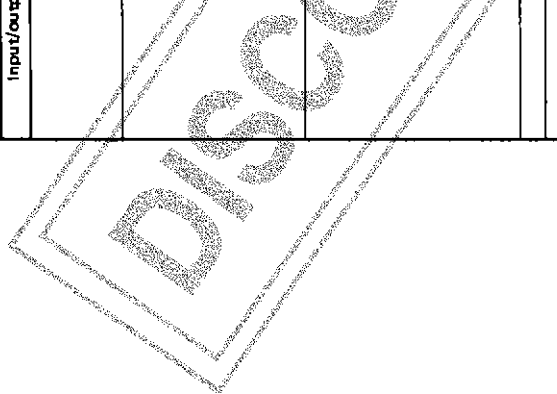

Continued from preceding page.

Instruction	Mnemonic	Instruction code								Bytes	Cycles	Function	Description	Status flag to be affected	
		D7	D6	D5	D4	D3	D2	D1	D0						
Input/output instructions	RAS	Reset Alarm Sound	1	1	1	1	1	0	1	0	2	2	=SAS FF	The ALM1 outputs are set to "L" level	
	SPDR X	Set/Reset PDF-Register	1	1	1	1	0	1	X1	X0	1	1	PDF ← X	The pull-down MOS Tr of the corresponding input port is turned ON/OFF. Operation X0=0 S-Terminal Pull down Tr OFF X0=1 S-Terminal Pull down Tr ON X1=0 M-Terminal Pull down Tr OFF X1=1 M-Terminal Pull down Tr ON	PDF
	OUT	Write AC & M(DP) to LCD Latch L(SP) (SP=#0 to C)	1	1	1	1	1	1	0	0	1	1		The AC memory [M(DP)] contents are loaded to the LCD latch L(SP) directly addressed by the SP.	
		SP=#D Move AC to CTL3											CTL3 ←(AC)	Output AC contents to CTL3.	
		SP=#E Write AC to P(P00-03)											P(P0) ←AC	The AC contents are loaded to the Port P0.	
		SP=#F Write AC to P(P10-13)											P(P1) ←AC	The AC contents are loaded to the Port P1.	
	IN	SP=#D Load AC from STS3											AC ←(STS3)	Load STS3 contents into AC.	
		SP=#E Input Port-P0 to AC											AC ←P(P0)	The input data at Port P0 is loaded to the AC.	
		SP=#F Input Port-P1 to AC											AC ←P(P1)	The input data at Port P1 is loaded to the AC.	
	TWRT	Read Table data from Program ROM & Write Table data to LCD Latch (SP) (SP=#0 to C)	0	0	0	0	0	0	1	0	1	2		The data of ROM, on current page, addressed by the AC, M(DP) contents is loaded to the LCD latch L(SP) addressed by the SP.	
SP=#D Read Table data from Program ROM & Write Table data to CTL3													Output to CTL3 the ROM table data at the address in the current page area specified by AC and [M(DP)].		
SP=#E Read Table data from Program ROM & Write Table data to P(P00 to 03)													Output to port P0 the ROM table data at the address in the current page area specified by AC and [M(DP)].		
SP=#F Read Table Data from Program ROM & Write Table data to P(P10 to 13)													Output to port P1 the ROM table data at the address in the current page area specified by AC and [M(DP)].		
TMEL	Set Table data to Alarm Sound data	0	0	0	0	0	0	1	1	1	2		The data of ROM, on current page, addressed by the AC, M(DP) contents is set to alarm sound data and waveforms specified by the table data are delivered at ALM1. (Same as SAS instruction)		
Jump instructions	JMP X	Jump	0	0	0	0	1	X10	X9	X8	2	2	PC10←PC0←X10←X0	The data specified by X10 to X0 is loaded to the PC to cause an unconditional jump.	
	BAB0 X	Branch on AC bit 0 High	0	1	0	0	1	X10	X9	X8	2	2	PC10←PC0←X10←X0 if AC0=[1]	If bit 0 of the AC is "1", a jump occurs. If "0", the PC is incremented +1.	
	BAB1 X	Branch on AC bit 1 High	0	1	0	1	1	X10	X9	X8	2	2	PC10←PC0←X10←X0 if AC1=[1]	If bit 1 of the AC is "1", a jump occurs. If "0", the PC is incremented +1.	
	BAB2 X	Branch on AC bit 2 High	0	1	1	0	1	X10	X9	X8	2	2	PC10←PC0←X10←X0 if AC2=[1]	If bit 2 of the AC is "1", a jump occurs. If "0", the PC is incremented +1.	
	BAB3 X	Branch on AC bit 3 High	0	1	1	1	1	X10	X9	X8	2	2	PC10←PC0←X10←X0 if AC3=[1]	If bit 3 of the AC is "1", a jump occurs. If "0", the PC is incremented +1.	
	BANZ X	Branch on AC not Zero	0	1	0	1	0	X10	X9	X8	2	2	PC10←PC0←X10←X0 if AC≠0	If the AC is not "0", a jump occurs. If "0", the PC is incremented +1.	
	BAZ X	Branch on AC zero	0	1	0	0	0	X10	X9	X8	2	2	PC10←PC0←X10←X0 if AC=0	If the AC is "0", a jump occurs. If not "0", the PC is incremented +1.	
	BCNH X	Branch on CF not High	0	1	1	0	0	X10	X9	X8	2	2	PC10←PC0←X10←X0 if CF=0	If the CF is "0", a jump occurs. If "1", the PC is incremented +1.	
	BCH X	Branch on CF High	0	1	1	1	0	X10	X9	X8	2	2	PC10←PC0←X10←X0 if CF=1	If the CF is "1", a jump occurs. If "0", the PC is incremented +1.	
	PAGE	Page Set	0	0	0	1	0	0	0	1	1	1	PAGE ← [M(DP)]	The memory [M(DP)] contents are loaded to the PAGE latch.	

Continued on next page.

Continued from preceding page.

Instruction	Mnemonic	Instruction code								Bytes	Cycles	Function	Description	Status flag to be affected
		D7	D6	D5	D4	D3	D2	D1	D0					
Jump instructions	JMP*	0 0 0 1 0 0 0 0								1	1	PC10-PC8-(PAGE) PC7-PC4-(AC) PC3-PC0-(MIDP)	An unconditional jump occurs to a page specified by the PAGE and an address low-order 8 bits of the PC which are loaded with the AC and memory M(DP) contents.	
	JSR X	1 0 1 0 0 X ₁₀ X ₉ X ₈ X ₇ X ₆ X ₅ X ₄ X ₃ X ₂ X ₁ X ₀								2	2	STACK - PC+2 PC10-PC0-X ₁₀ -X ₀	A subroutine is called.	
Subroutine instructions	RTS	0 0 0 1 0 0 1 1								1	1	PC - (STACK)	A return from a subroutine occurs.	
Other instructions	MPCL	0 0 0 1 0 1 0 0								1	1	M(DP)-PC3-PC0	The contents of the low-order 4 bits of the PC are stored in the memory M(DP).	
	MPCM	0 0 0 1 0 1 0 1								1	1	M(DP)-PC7-PC4	The contents of the medium-order 4 bits of the PC are stored in the memory M(DP).	
	MPCH	0 0 0 1 0 1 1 0								1	1	M(DP)-PC10-PC8	The contents of the high-order 3 bits of the PC are stored in the memory M(DP).	
	CSEC	1 1 1 1 1 0 1 1								1	1		The high-order 5 bits of the predivider are reset and the SCF0, SCF1, SCF4 are reset.	SCF0 SCF1 SCF4

■ No products described or contained herein are intended for use in surgical implants, life-support systems, aerospace equipment, nuclear power control systems, vehicles, disaster/crime-prevention equipment and the like, the failure of which may directly or indirectly cause injury, death or property loss.

■ Anyone purchasing any products described or contained herein for an above-mentioned use shall:

- ① Accept full responsibility and indemnify and defend SANYO ELECTRIC CO., LTD., its affiliates, subsidiaries and distributors and all their officers and employees, jointly and severally, against any and all claims and litigation and all damages, cost and expenses associated with such use;
- ② Not impose any responsibility for any fault or negligence which may be cited in any such claim or litigation on SANYO ELECTRIC CO., LTD., its affiliates, subsidiaries and distributors or any of their officers and employees jointly or severally.

■ Information (including circuit diagrams and circuit parameters) herein is for example only; it is not guaranteed for volume production. SANYO believes information herein is accurate and reliable, but no guarantees are made or implied regarding its use or any infringements of intellectual property rights or other rights of third parties.