

DATA SHEET

TDA8542TS

2 × 0.7 W BTL audio amplifier

Product specification
Supersedes data of 1997 Nov 17
File under Integrated Circuits, IC01

1998 Mar 25

2 × 0.7 W BTL audio amplifier**TDA8542TS****FEATURES**

- Flexibility in use
- Few external components
- Low saturation voltage of output stage
- Gain can be fixed with external resistors
- Standby mode controlled by CMOS compatible levels
- Low standby current
- No switch-on/switch-off plops
- High supply voltage ripple rejection
- Protected against electrostatic discharge
- Outputs short-circuit safe to ground, V_{CC} and across the load
- Thermally protected.

GENERAL DESCRIPTION

The TDA8542TS is a two channel audio power amplifier for an output power of 2×0.7 W with a 16Ω load at a 5 V supply. At a low supply voltage of 3.3 V an output power of 0.6 W with an 8Ω load can be obtained. The circuit contains two Bridge-Tied Load (BTL) amplifiers with a complementary PNP-NPN output stage and standby/mute logic. The TDA8542TS is available in a SSOP20 package.

APPLICATIONS

- Portable consumer products
- Personal computers
- Motor-driver (servo).

QUICK REFERENCE DATA

SYMBOL	PARAMETER	CONDITIONS	MIN.	TYP.	MAX.	UNIT
V_{CC}	supply voltage		2.2	5	18	V
I_q	quiescent current	$V_{CC} = 5$ V	–	15	22	mA
I_{stb}	standby current		–	–	10	μ A
P_o	output power	THD = 10%; $R_L = 8 \Omega$; $V_{CC} = 3.3$ V	0.45	0.55	–	W
		THD = 10%; $R_L = 16 \Omega$; $V_{CC} = 5$ V	0.6	0.7	–	W
THD	total harmonic distortion	$P_o = 0.4$ W	–	0.15	–	%
SVRR	supply voltage ripple rejection		50	–	–	dB

ORDERING INFORMATION

TYPE NUMBER	PACKAGE		
	NAME	DESCRIPTION	VERSION
TDA8542TS	SSOP20	plastic shrink small outline package; 20 leads; body width 4.4 mm	SOT266-1

2 × 0.7 W BTL audio amplifier

TDA8542TS

BLOCK DIAGRAM

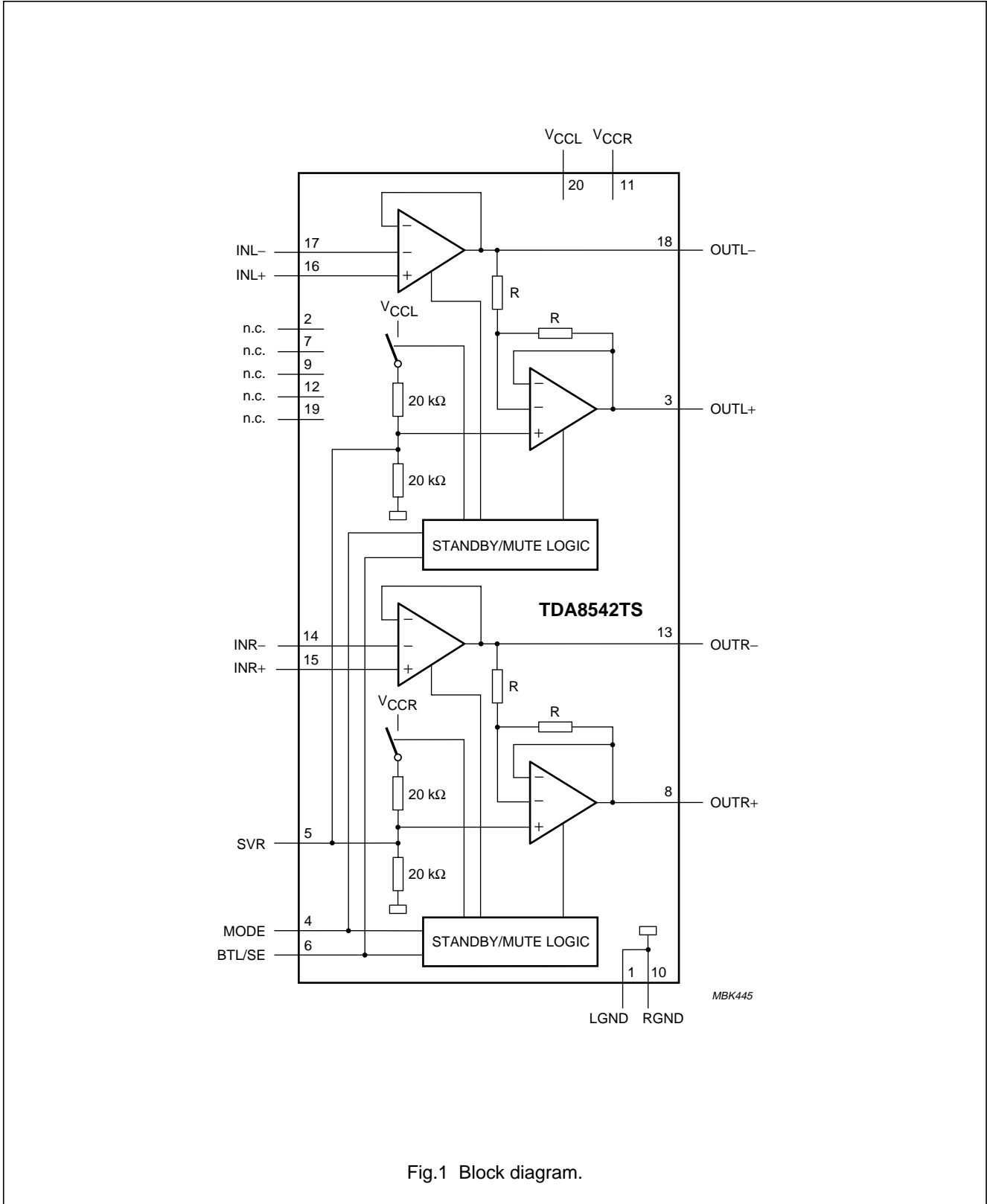

Fig.1 Block diagram.

2 × 0.7 W BTL audio amplifier

TDA8542TS

PINNING

SYMBOL	PIN	DESCRIPTION
LGND	1	ground, left channel
n.c.	2	not connected
OUTL+	3	positive loudspeaker terminal, left channel
MODE	4	operating mode select (standby, mute, operating)
SVR	5	half supply voltage, decoupling ripple rejection
BTL/SE	6	BTL loudspeaker or SE headphone operation
n.c.	7	not connected
OUTR+	8	positive loudspeaker terminal, right channel
n.c.	9	not connected
RGND	10	ground, right channel
V _{CCR}	11	supply voltage, right channel
n.c.	12	not connected
OUTR-	13	negative loudspeaker terminal, right channel
INR-	14	negative input, right channel
INR+	15	positive input, right channel
INL+	16	positive input, left channel
INL-	17	negative input, left channel
OUTL-	18	negative loudspeaker terminal, left channel
n.c.	19	not connected
V _{CCL}	20	supply voltage, left channel

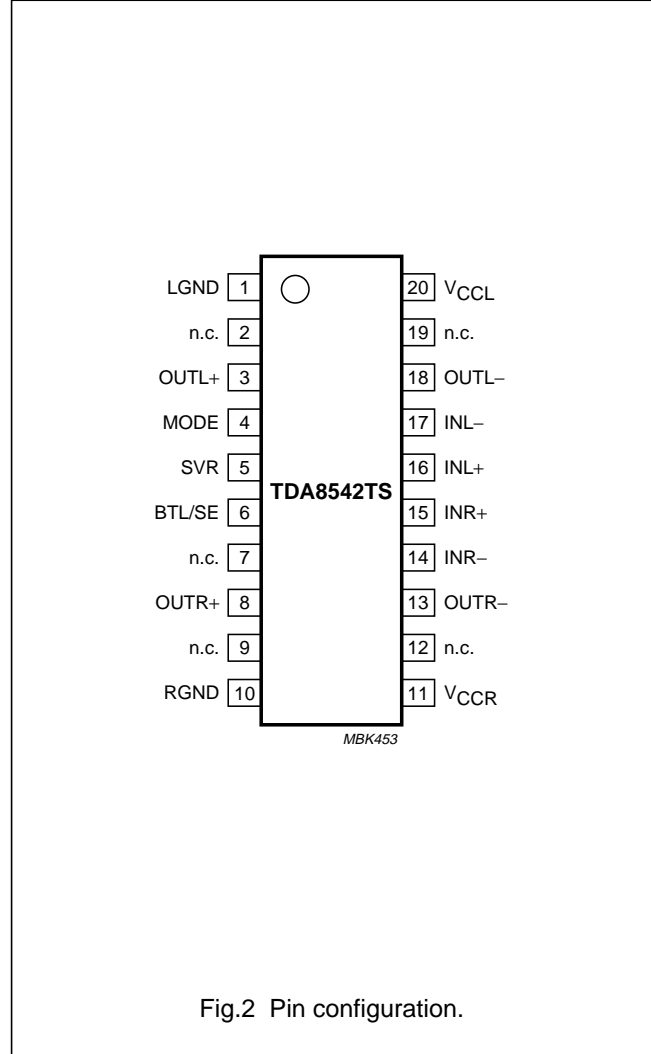

Fig.2 Pin configuration.

FUNCTIONAL DESCRIPTION

The TDA8542TS is a 2 × 0.7 W BTL audio power amplifier capable of delivering 2 × 0.7 W output power to a 16 Ω load at THD = 10% using a 5 V power supply. Using the MODE pin the device can be switched to standby and mute condition. The device is protected by an internal thermal shutdown protection mechanism. The gain can be set within a range from 6 to 30 dB by external feedback resistors.

Power amplifier

The power amplifier is a Bridge-Tied Load (BTL) amplifier with a complementary PNP-NPN output stage. The voltage loss on the positive supply line is the saturation voltage of a PNP power transistor, on the

negative side the saturation voltage of a NPN power transistor. The total voltage loss is <1 V and with a 5 V supply voltage and with a 16 Ω loudspeaker an output power of 0.7 W can be delivered.

Mode select pin

The device is in the standby mode (with a very low current consumption) if the voltage at the MODE pin is >(V_{CC} - 0.5 V), or if this pin is floating. At a MODE voltage level of less than 0.5 V the amplifier is fully operational. In the range between 1.5 V and V_{CC} - 1.5 V the amplifier is in mute condition. The mute condition is useful to suppress plop noise at the output caused by charging of the input capacitor.

2 × 0.7 W BTL audio amplifier**TDA8542TS****Headphone connection**

A headphone can be connected to the amplifier using two coupling capacitors for each channel. The common GND pin of the headphone is connected to the ground of the amplifier (see Fig.13). In this case the BTL/SE pin must be either at a logic HIGH level or not connected at all.

The two coupling capacitors can be omitted if it is allowed to connect the common GND pin of the headphone jack

not to ground, but to a voltage level of $\frac{1}{2}V_{CC}$. See Fig.4 for the application diagram. In this case the BTL/SE pin must be either at a logic LOW level or connected to ground. If the BTL/SE pin is at a LOW level, the power amplifier for the positive loudspeaker terminal is always in mute condition.

LIMITING VALUES

In accordance with the Absolute Maximum Rating System (IEC 134).

SYMBOL	PARAMETER	CONDITIONS	MIN.	MAX.	UNIT
V_{CC}	supply voltage	operating	-0.3	+18	V
V_I	input voltage		-0.3	$V_{CC} + 0.3$	V
I_{ORM}	repetitive peak output current		-	1	A
T_{stg}	storage temperature	non-operating	-55	+150	°C
T_{amb}	operating ambient temperature		-40	+85	°C
V_{sc}	AC and DC short-circuit safe voltage		-	10	V
P_{tot}	total power dissipation		-	1.12	W

QUALITY SPECIFICATION

In accordance with "SNW-FQ-611-E".

THERMAL CHARACTERISTICS

SYMBOL	PARAMETER	CONDITIONS	VALUE	UNIT
$R_{th(j-a)}$	thermal resistance from junction to ambient	in free air	110 ⁽¹⁾	K/W

Note

1. See Section "Thermal design considerations".

Table 1 Maximum ambient temperature at different conditions

V_{CC} (V)	R_L (Ω)	P_o (W)	CONTINUOUS SINE WAVE DRIVEN	
			P_{max} (W)	$T_{amb(max)}$ (°C)
3.3	4	2×0.65	1.12	27 ⁽¹⁾
3.3	8	2×0.55	0.60	84
5	8	2×1.2	1.33	-(1)
5	16	2×0.70	0.80	62

Note

1. See Section "Thermal design considerations".

2 × 0.7 W BTL audio amplifier**TDA8542TS****DC CHARACTERISTICS**

$V_{CC} = 5\text{ V}$; $T_{amb} = 25\text{ °C}$; $R_L = 8\ \Omega$; $V_{MODE} = 0\text{ V}$; measured in test circuit Fig.3; unless otherwise specified.

SYMBOL	PARAMETER	CONDITIONS	MIN.	TYP.	MAX.	UNIT
V_{CC}	supply voltage	operating	2.2	5	18	V
I_q	quiescent current	$R_L = \infty$; note 1	–	15	22	mA
I_{stb}	standby current	$V_{MODE} = V_{CC}$	–	–	10	μA
V_O	DC output voltage	note 2	–	2.2	–	V
$ V_{OUT+} - V_{OUT-} $	differential output voltage offset		–	–	50	mV
I_{IN+}, I_{IN-}	input bias current		–	–	500	nA
V_{MODE}	input voltage mode select	operating	0	–	0.5	V
		mute	1.5	–	$V_{CC} - 1.5$	V
		standby	$V_{CC} - 0.5$	–	V_{CC}	V
I_{MODE}	input current mode select	$0 < V_{MODE} < V_{CC}$	–	–	20	μA
$V_{BTL/SE}$	input voltage BTL/SE pin	single-ended	0	–	0.6	V
		BTL	2	–	V_{CC}	V
$I_{BTL/SE}$	input current BTL/SE pin	$V_{BTL/SE} = 0$	–	–	100	μA

Notes

1. With a load connected at the outputs the quiescent current will increase, the maximum of this increase being equal to the DC output offset voltage divided by R_L .
2. The DC output voltage with respect to ground is approximately $\frac{1}{2}V_{CC}$.

2 × 0.7 W BTL audio amplifier**TDA8542TS****AC CHARACTERISTICS**

$V_{CC} = 5\text{ V}$; $T_{amb} = 25\text{ °C}$; $R_L = 8\ \Omega$; $f = 1\text{ kHz}$; $V_{MODE} = 0\text{ V}$; measured in test circuit Fig.3; unless otherwise specified.

SYMBOL	PARAMETER	CONDITIONS	MIN.	TYP.	MAX.	UNIT	
P_o	output power	at $V_{CC} = 5\text{ V}$					
		THD = 10%; $R_L = 8\ \Omega$	–	1.2	–	W	
		THD = 10%; $R_L = 16\ \Omega$	–	0.70	–	W	
		THD = 0.5%; $R_L = 8\ \Omega$	–	0.9	–	W	
		THD = 0.5%; $R_L = 16\ \Omega$	–	0.5	–	W	
		at $V_{CC} = 3.3\text{ V}$					
		THD = 10%; $R_L = 4\ \Omega$	–	0.65	–	W	
		THD = 10%; $R_L = 8\ \Omega$	–	0.55	–	W	
		THD = 0.5%; $R_L = 4\ \Omega$	–	0.45	–	W	
		THD = 0.5%; $R_L = 8\ \Omega$	–	0.38	–	W	
THD	total harmonic distortion	$P_o = 0.4\text{ W}$	–	0.15	0.3	%	
$G_{V(cl)}$	closed-loop voltage gain	note 1	6	–	30	dB	
$Z_{i(dif)}$	differential input impedance		–	100	–	k Ω	
$V_{n(o)}$	noise output voltage	note 2	–	–	100	μV	
SVRR	supply voltage ripple rejection	note 3	50	–	–	dB	
		note 4	40	–	–	dB	
$V_{o(mute)}$	output voltage in mute condition	note 5	–	–	200	μV	
α_{CS}	channel separation		40	–	–	dB	

Notes

- Gain of the amplifier is $2 \times \frac{R_2}{R_1}$ in test circuit of Fig.3.
- The noise output voltage is measured at the output in a frequency range from 20 Hz to 20 kHz (unweighted), with a source impedance of $R_S = 0\ \Omega$ at the input.
- Supply voltage ripple rejection is measured at the output, with a source impedance of $R_S = 0\ \Omega$ at the input. The ripple voltage is a sine wave with a frequency of 1 kHz and an amplitude of 100 mV (RMS), which is applied to the positive supply rail.
- Supply voltage ripple rejection is measured at the output, with a source impedance of $R_S = 0\ \Omega$ at the input. The ripple voltage is a sine wave with a frequency between 100 Hz and 20 kHz and an amplitude of 100 mV (RMS), which is applied to the positive supply rail.
- Output voltage in mute position is measured with a 1 V (RMS) input voltage in a bandwidth of 20 kHz, so including noise.

2 × 0.7 W BTL audio amplifier**TDA8542TS****TEST AND APPLICATION INFORMATION****Test conditions**

Because the application can be either Bridge-Tied Load (BTL) or Single-Ended (SE), the curves of each application are shown separately.

The thermal resistance = 110 K/W for the SSOP20; the maximum sine wave power dissipation for $T_{\text{amb}} = 25\text{ }^{\circ}\text{C}$ is:

$$\frac{150 - 25}{110} = 1.14\text{ W}$$

For $T_{\text{amb}} = 60\text{ }^{\circ}\text{C}$ the maximum total power dissipation is:

$$\frac{150 - 60}{110} = 0.82\text{ W}$$

Thermal design considerations

The 'measured' thermal resistance of the IC package is highly dependent on the configuration and size of the application board. Data may not be comparable between different semiconductor manufacturers because the application boards and test methods are not (yet) standardized. Also, the thermal performance of packages for a specific application may be different than presented here, because the configuration of the application boards (copper area) may be different. Philips Semiconductors uses FR-4 type application boards with 1 oz copper traces with solder coating.

The SSOP package has improved thermal conductivity which reduces the thermal resistance. Using a practical PCB layout (see Fig.22) with wider copper tracks to the corner pins and just under the IC, the thermal resistance from junction to ambient can be reduced to approximately 80 K/W. For $T_{\text{amb}} = 60\text{ }^{\circ}\text{C}$ the maximum total power

dissipation for this PCB layout is: $\frac{150 - 60}{80} = 1.12\text{ W}$

BTL application

$T_{\text{amb}} = 25\text{ }^{\circ}\text{C}$ if not specially mentioned, $V_{\text{CC}} = 5\text{ V}$, $f = 1\text{ kHz}$, $R_{\text{L}} = 8\text{ }\Omega$, $G_{\text{v}} = 20\text{ dB}$, audio band-pass 22 Hz to 22 kHz.

The BTL application diagram is illustrated in Fig.3.

The quiescent current has been measured without any load impedance. The total harmonic distortion as a

function of frequency was measured with a low-pass filter of 80 kHz. The value of capacitor C3 influences the behaviour of the SVRR at low frequencies, increasing the value of C3 increases the performance of the SVRR. The figure of the mode select voltage (V_{ms}) as a function of the supply voltage shows three areas; operating, mute and standby. It shows, that the DC-switching levels of the mute and standby respectively depends on the supply voltage level.

SE application

$T_{\text{amb}} = 25\text{ }^{\circ}\text{C}$ if not specially mentioned, $V_{\text{CC}} = 7.5\text{ V}$, $f = 1\text{ kHz}$, $R_{\text{L}} = 4\text{ }\Omega$, $G_{\text{v}} = 20\text{ dB}$, audio band-pass 22 Hz to 22 kHz.

The SE application diagram is illustrated in Fig.14.

If the BTL/SE pin (pin 6) is connected to ground, the positive outputs (pins 3 and 8) will be in mute condition with a DC level of $\frac{1}{2}V_{\text{CC}}$. When a headphone is used ($R_{\text{L}} \geq 25\text{ }\Omega$) the SE headphone application can be used without output coupling capacitors; load between negative output and one of the positive outputs (e.g. pin 3) as common pin. The channel separation will be less in comparison with the application using a coupling capacitor connected to ground.

Increasing the value of electrolytic capacitor C3 will result in a better channel separation. Because the positive output is not designed for high output current ($2 \times I_{\text{o}}$) at low load impedance ($\leq 16\text{ }\Omega$), the SE application with output capacitors connected to ground is advised. The capacitor value of C4/C5 in combination with the load impedance determines the low frequency behaviour. The THD as a function of frequency was measured using a low-pass filter of 80 kHz. The value of capacitor C3 influences the behaviour of the SVRR at low frequencies, increasing the value of C3 increases the performance of the SVRR.

General remark

The frequency characteristic can be adapted by connecting a small capacitor across the feedback resistor. To improve the immunity of HF radiation in radio circuit applications, a small capacitor can be connected in parallel with the feedback resistor (56 k Ω); this creates a low-pass filter.

2 × 0.7 W BTL audio amplifier

TDA8542TS

BTL APPLICATION

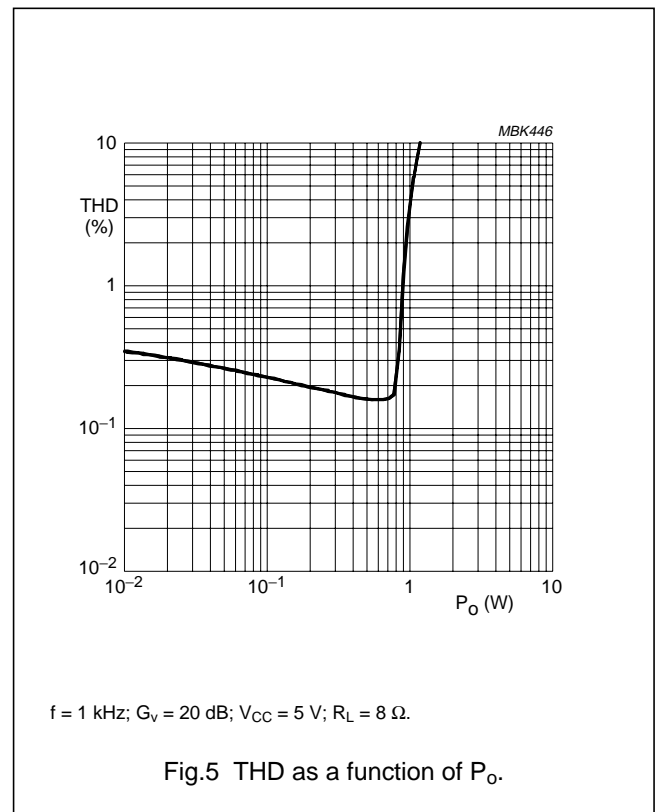
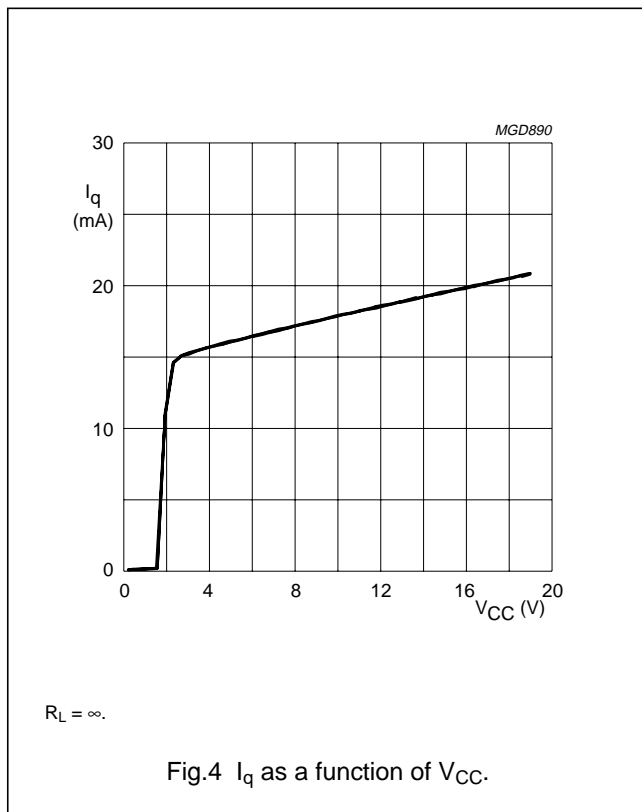
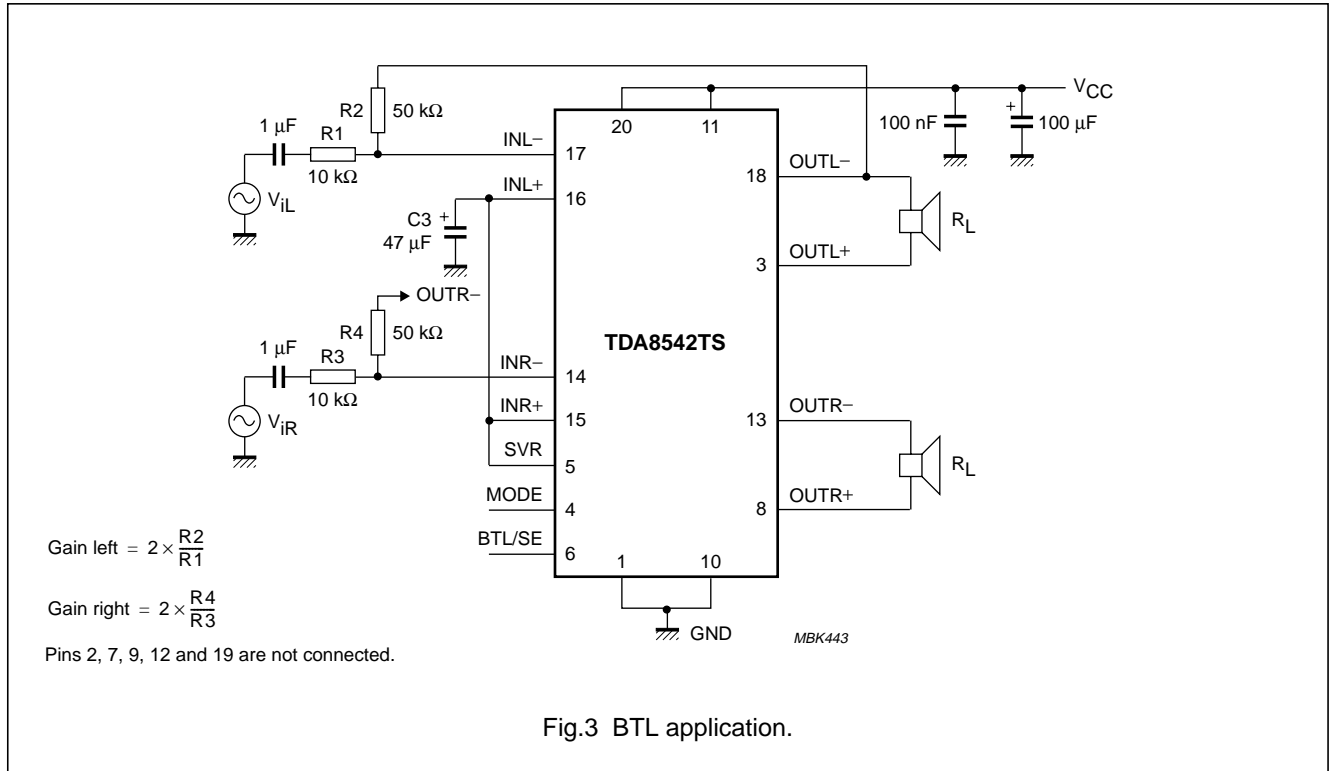

2 × 0.7 W BTL audio amplifier

TDA8542TS

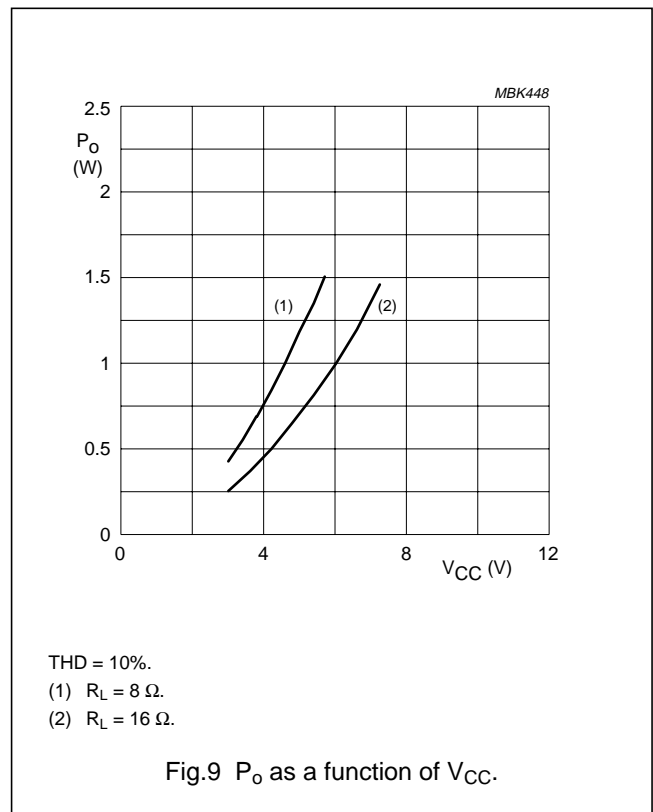
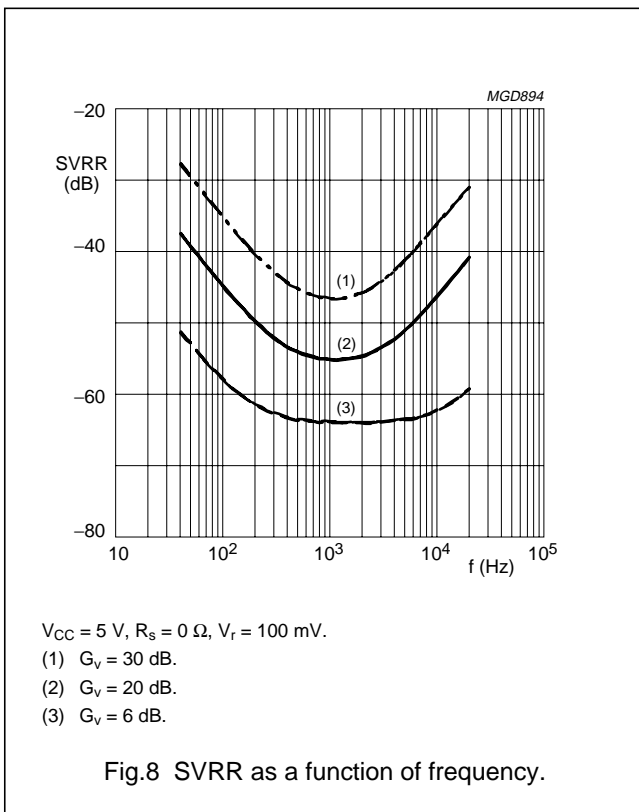
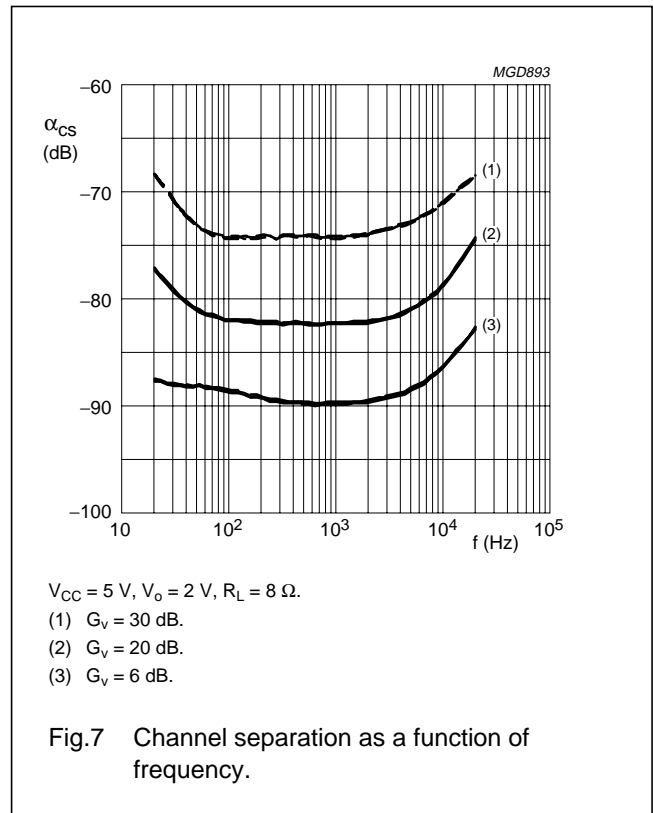
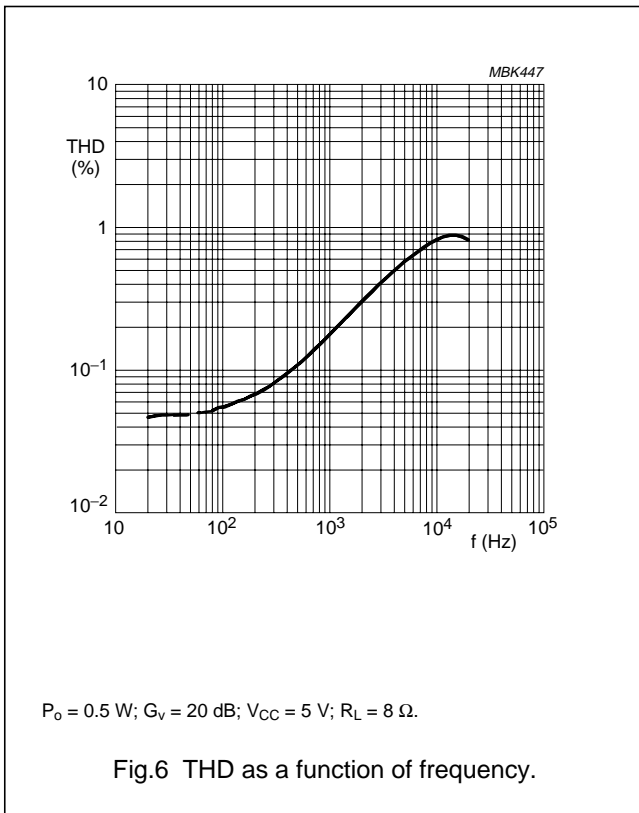

2 × 0.7 W BTL audio amplifier

TDA8542TS

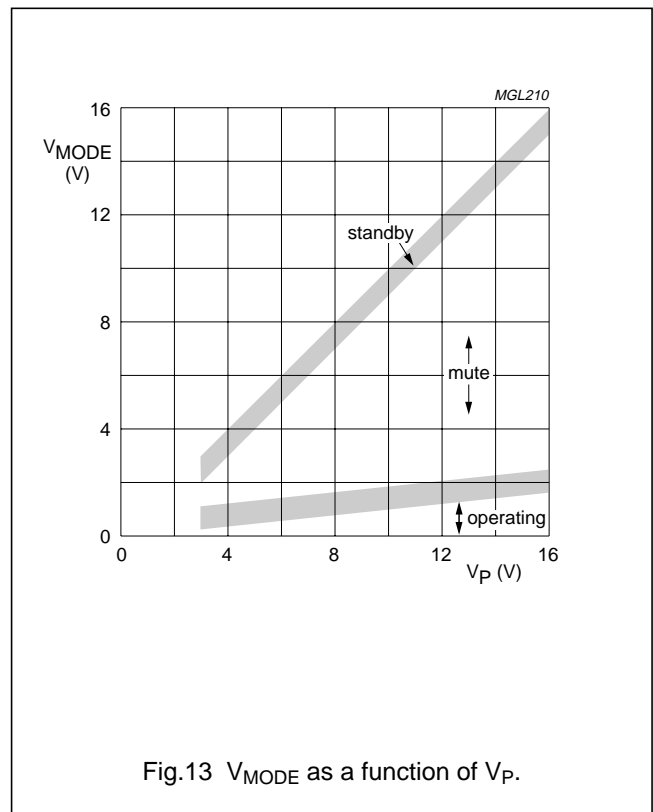
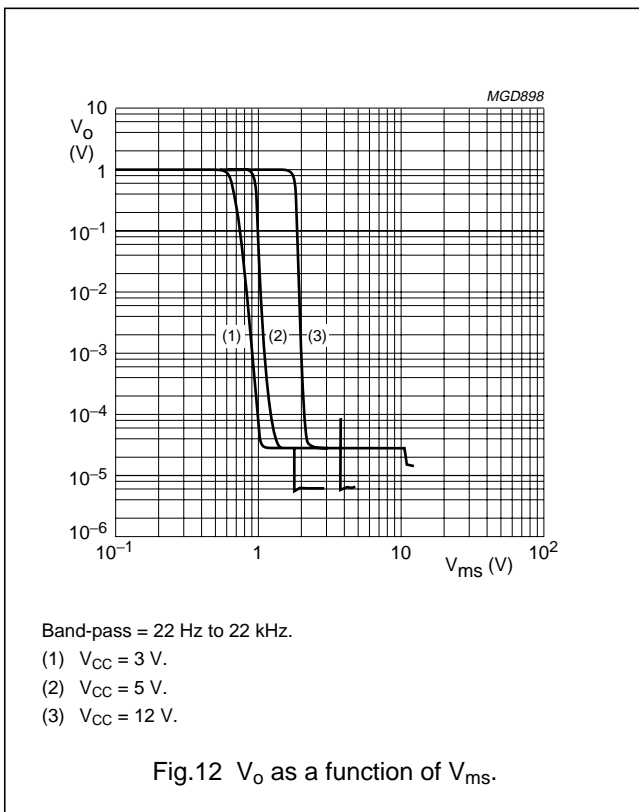
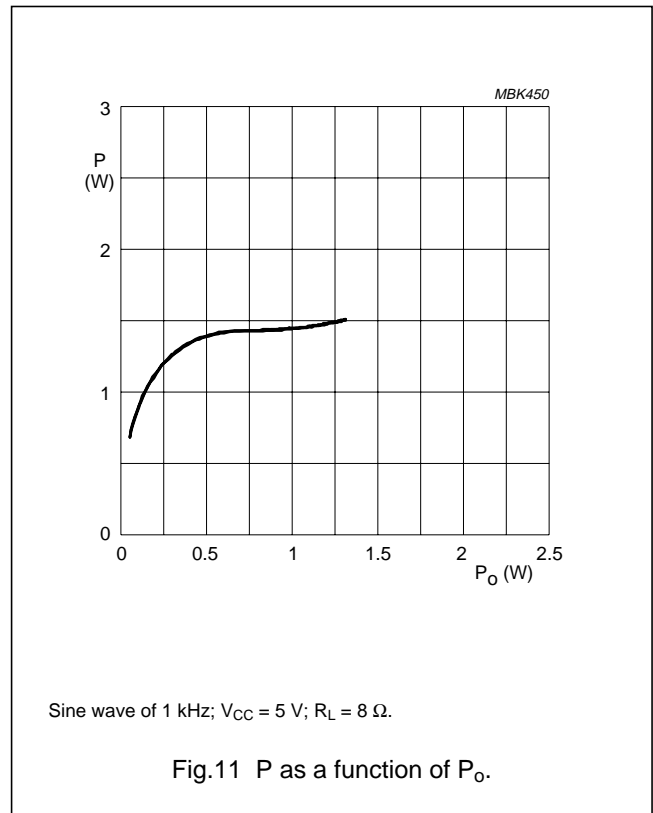
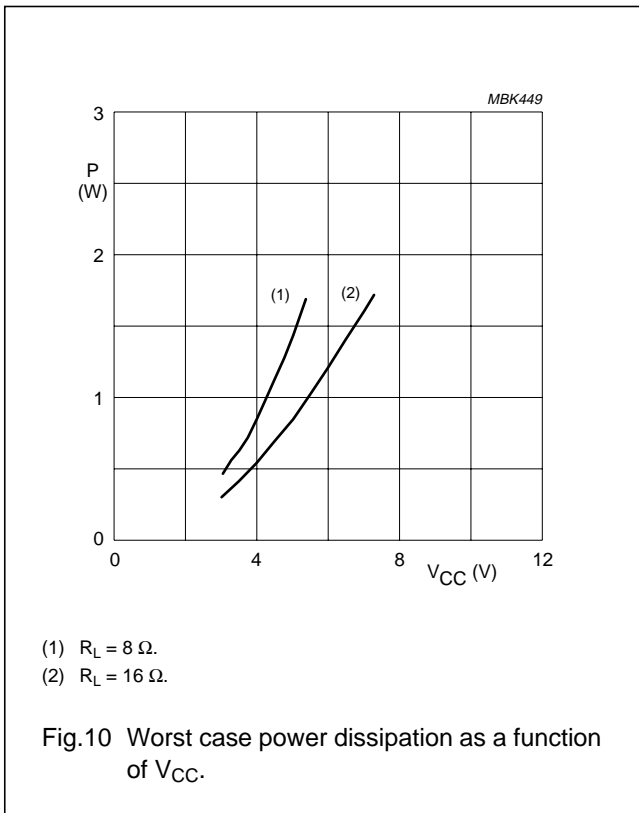

2 × 0.7 W BTL audio amplifier

TDA8542TS

SE APPLICATION

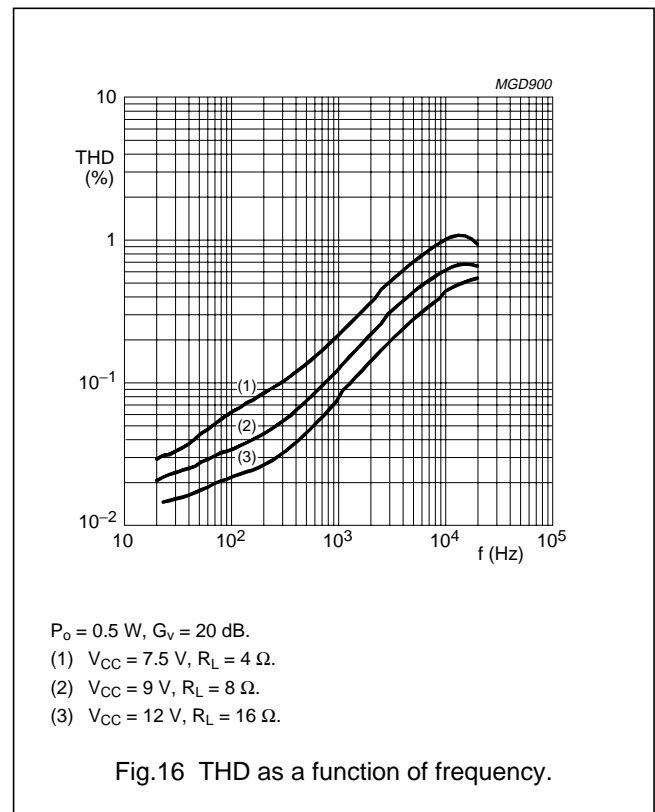
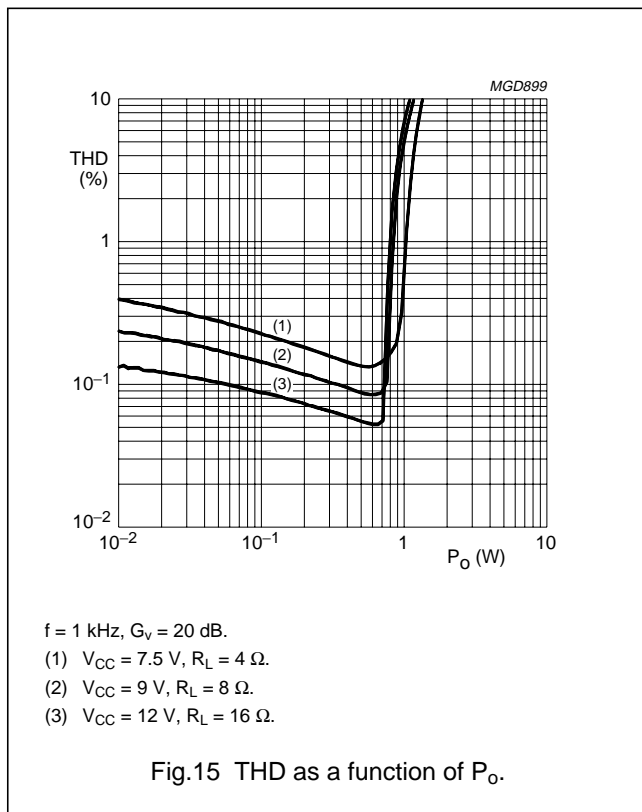
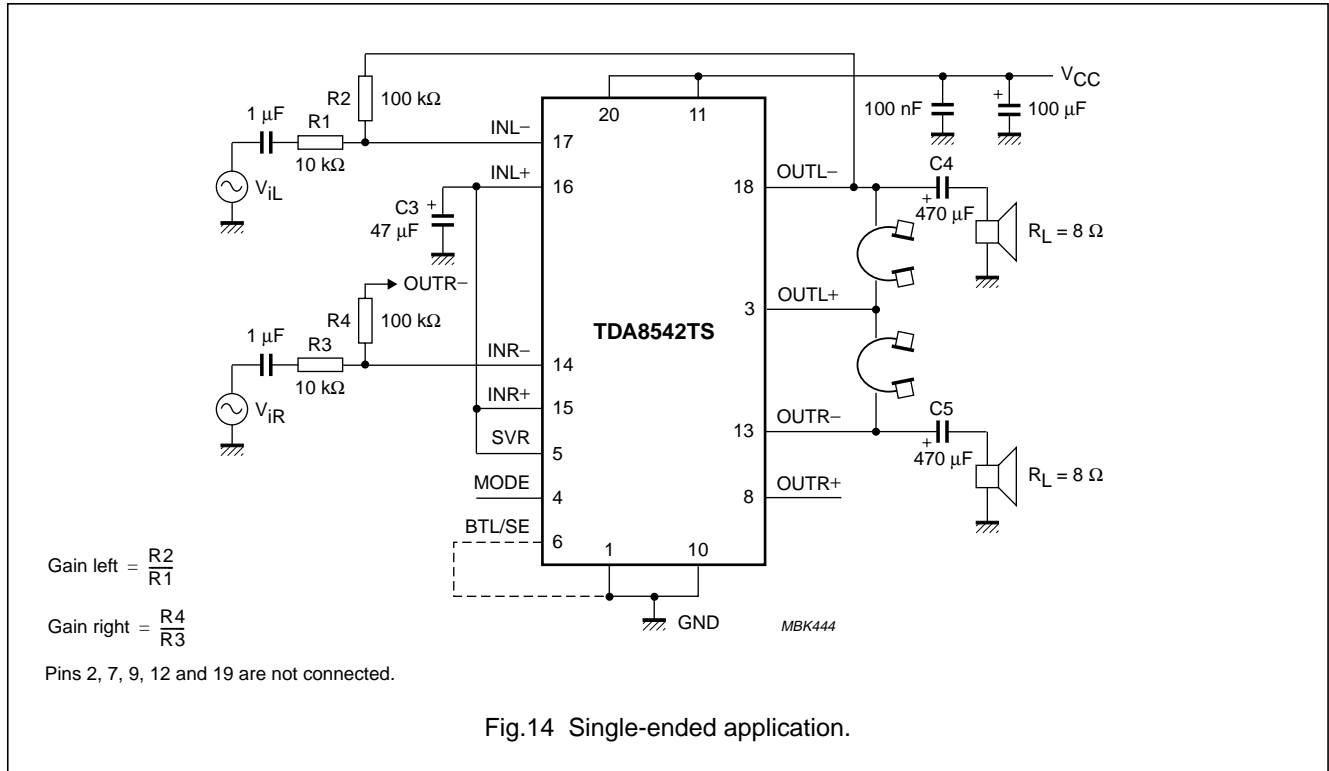

2 × 0.7 W BTL audio amplifier

TDA8542TS

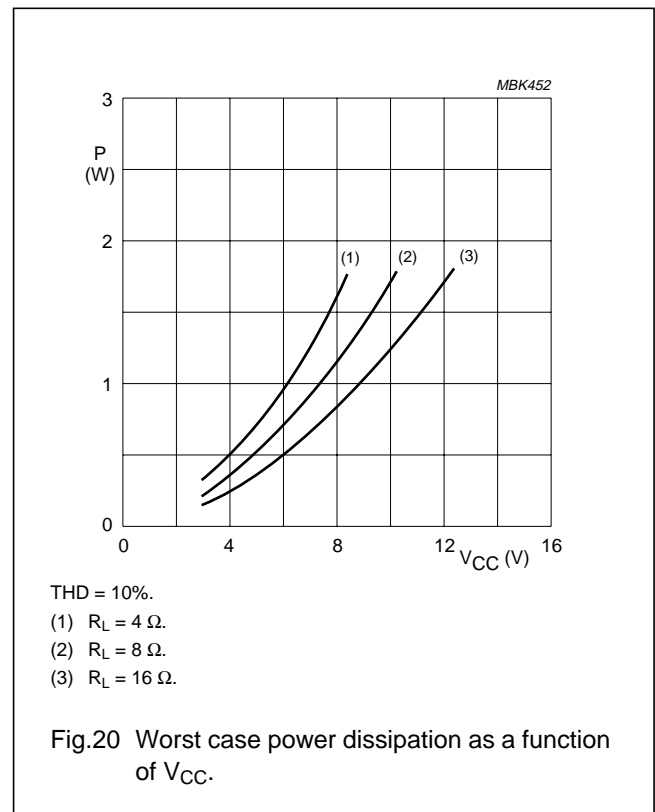
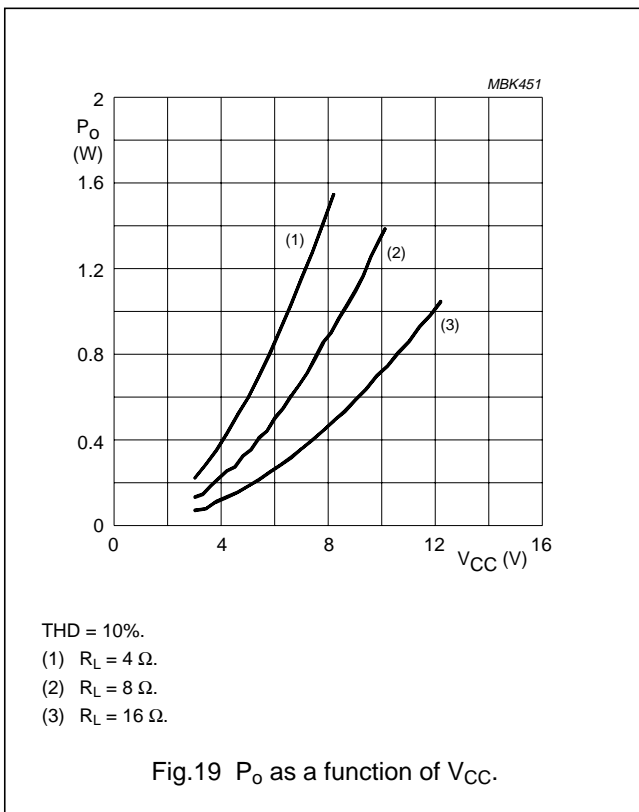
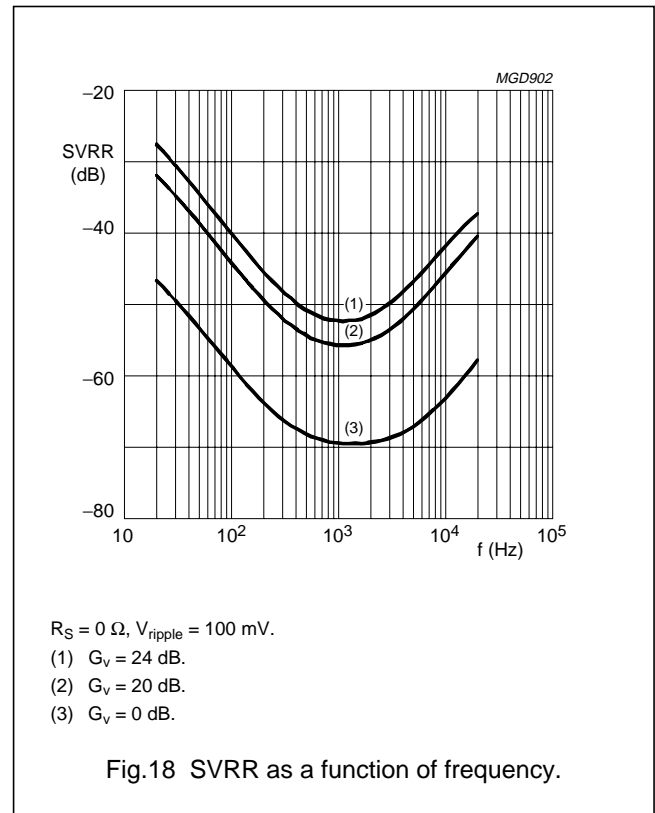
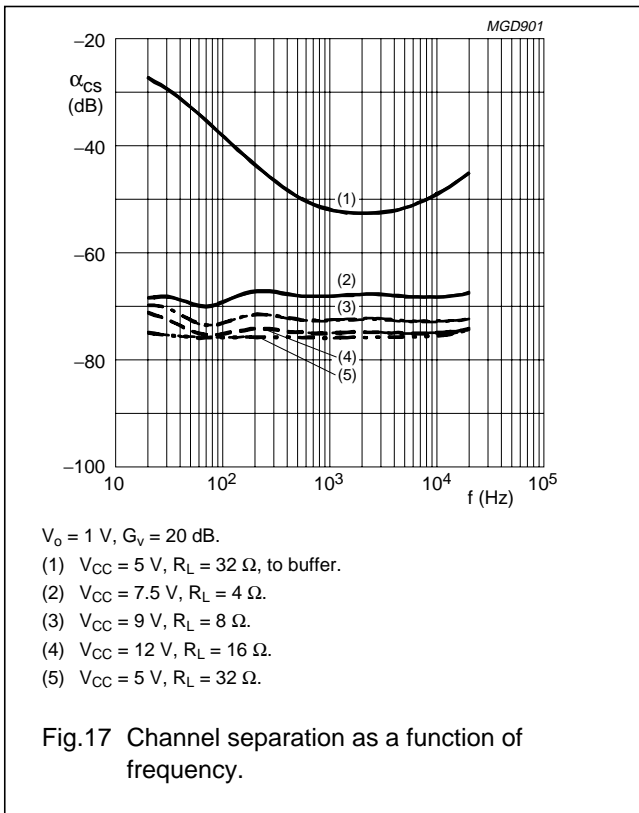

2 × 0.7 W BTL audio amplifier

TDA8542TS

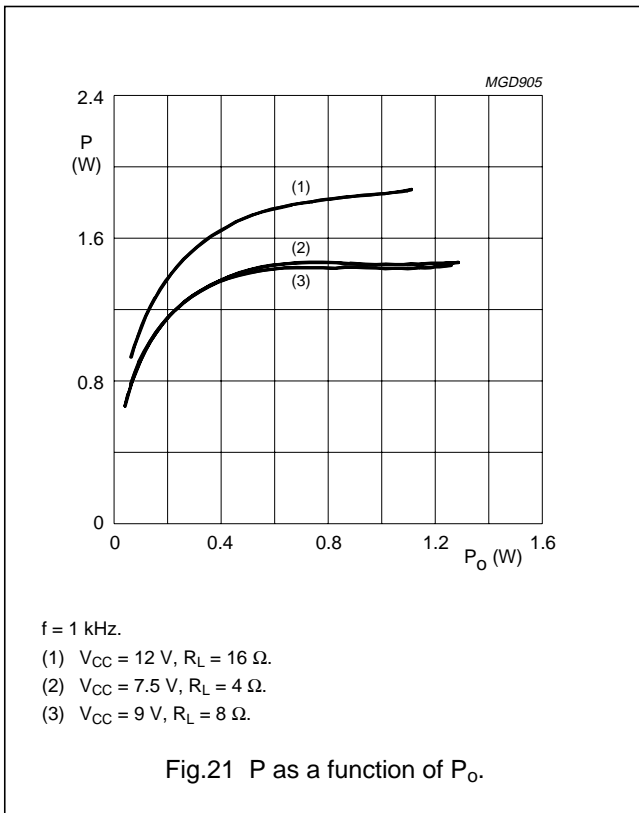

2 × 0.7 W BTL audio amplifier

TDA8542TS

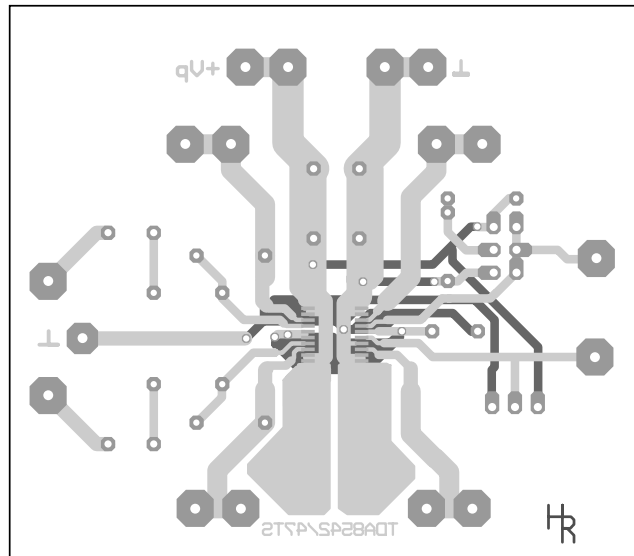

a. Top view copper layout.

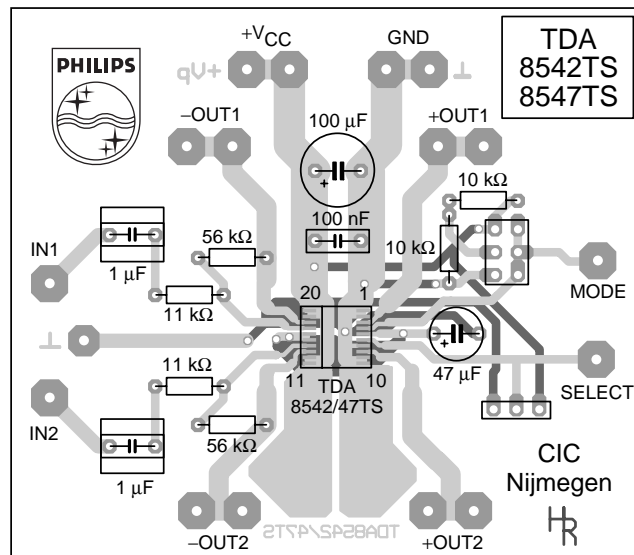

b. Top view components layout.

Fig.22 Printed-circuit board layout (BTL).

2 × 0.7 W BTL audio amplifier

TDA8542TS

PACKAGE OUTLINE

SSOP20: plastic shrink small outline package; 20 leads; body width 4.4 mm

SOT266-1

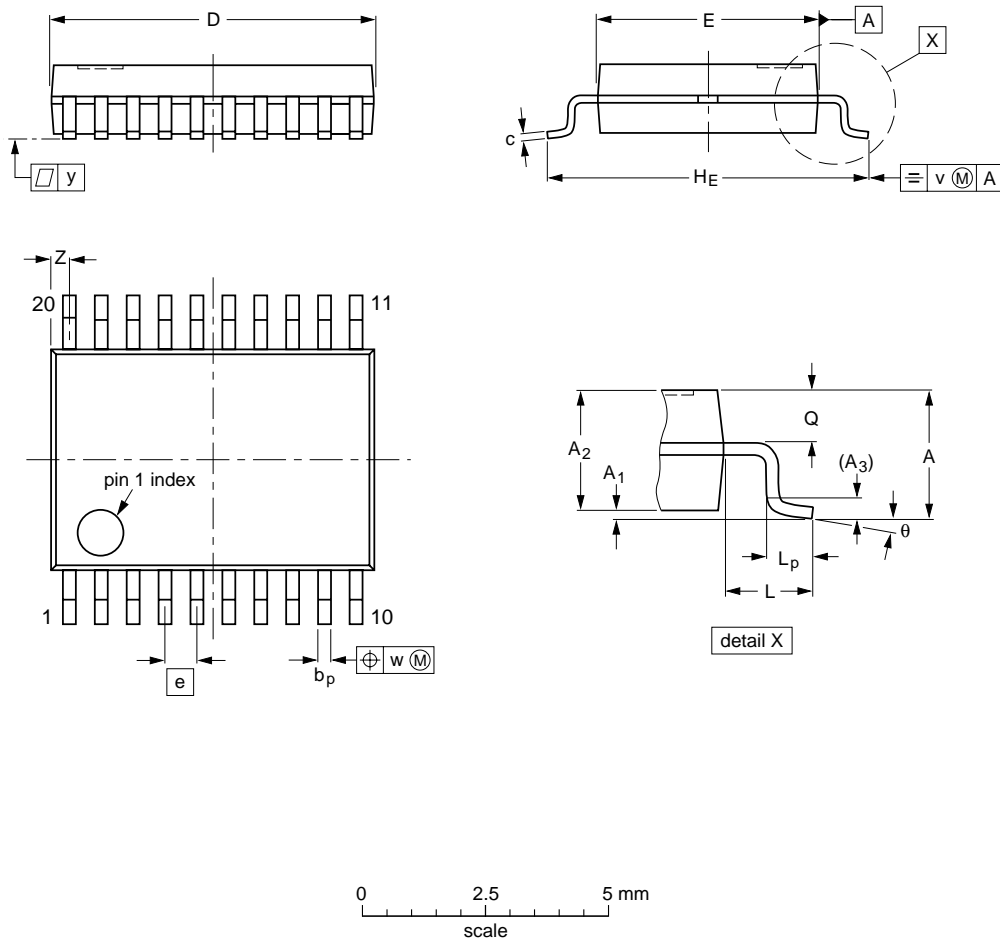

DIMENSIONS (mm are the original dimensions)

UNIT	A max.	A ₁	A ₂	A ₃	b _p	c	D ⁽¹⁾	E ⁽¹⁾	e	H _E	L	L _p	Q	v	w	y	Z ⁽¹⁾	θ
mm	1.5	0.15 0	1.4 1.2	0.25	0.32 0.20	0.20 0.13	6.6 6.4	4.5 4.3	0.65	6.6 6.2	1.0	0.75 0.45	0.65 0.45	0.2	0.13	0.1	0.48 0.18	10° 0°

Note

1. Plastic or metal protrusions of 0.20 mm maximum per side are not included.

OUTLINE VERSION	REFERENCES				EUROPEAN PROJECTION	ISSUE DATE
	IEC	JEDEC	EIAJ			
SOT266-1						90-04-05 95-02-25

2 × 0.7 W BTL audio amplifier**TDA8542TS**

SOLDERING**Introduction**

There is no soldering method that is ideal for all IC packages. Wave soldering is often preferred when through-hole and surface mounted components are mixed on one printed-circuit board. However, wave soldering is not always suitable for surface mounted ICs, or for printed-circuits with high population densities. In these situations reflow soldering is often used.

This text gives a very brief insight to a complex technology. A more in-depth account of soldering ICs can be found in our *"IC Package Databook"* (order code 9398 652 90011).

Reflow soldering

Reflow soldering techniques are suitable for all SSOP packages.

Reflow soldering requires solder paste (a suspension of fine solder particles, flux and binding agent) to be applied to the printed-circuit board by screen printing, stencilling or pressure-syringe dispensing before package placement.

Several techniques exist for reflowing; for example, thermal conduction by heated belt. Dwell times vary between 50 and 300 seconds depending on heating method. Typical reflow temperatures range from 215 to 250 °C.

Preheating is necessary to dry the paste and evaporate the binding agent. Preheating duration: 45 minutes at 45 °C.

Wave soldering

Wave soldering is **not** recommended for SSOP packages. This is because of the likelihood of solder bridging due to closely-spaced leads and the possibility of incomplete solder penetration in multi-lead devices.

If wave soldering cannot be avoided, the following conditions must be observed:

- **A double-wave (a turbulent wave with high upward pressure followed by a smooth laminar wave) soldering technique should be used.**
- **The longitudinal axis of the package footprint must be parallel to the solder flow and must incorporate solder thieves at the downstream end.**

Even with these conditions, only consider wave soldering SSOP packages that have a body width of 4.4 mm, that is SSOP16 (SOT369-1) or SSOP20 (SOT266-1).

During placement and before soldering, the package must be fixed with a droplet of adhesive. The adhesive can be applied by screen printing, pin transfer or syringe dispensing. The package can be soldered after the adhesive is cured.

Maximum permissible solder temperature is 260 °C, and maximum duration of package immersion in solder is 10 seconds, if cooled to less than 150 °C within 6 seconds. Typical dwell time is 4 seconds at 250 °C.

A mildly-activated flux will eliminate the need for removal of corrosive residues in most applications.

Repairing soldered joints

Fix the component by first soldering two diagonally-opposite end leads. Use only a low voltage soldering iron (less than 24 V) applied to the flat part of the lead. Contact time must be limited to 10 seconds at up to 300 °C. When using a dedicated tool, all other leads can be soldered in one operation within 2 to 5 seconds between 270 and 320 °C.

2×0.7 W BTL audio amplifier

TDA8542TS

DEFINITIONS

Data sheet status	
Objective specification	This data sheet contains target or goal specifications for product development.
Preliminary specification	This data sheet contains preliminary data; supplementary data may be published later.
Product specification	This data sheet contains final product specifications.
Limiting values	
Limiting values given are in accordance with the Absolute Maximum Rating System (IEC 134). Stress above one or more of the limiting values may cause permanent damage to the device. These are stress ratings only and operation of the device at these or at any other conditions above those given in the Characteristics sections of the specification is not implied. Exposure to limiting values for extended periods may affect device reliability.	
Application information	
Where application information is given, it is advisory and does not form part of the specification.	

LIFE SUPPORT APPLICATIONS

These products are not designed for use in life support appliances, devices, or systems where malfunction of these products can reasonably be expected to result in personal injury. Philips customers using or selling these products for use in such applications do so at their own risk and agree to fully indemnify Philips for any damages resulting from such improper use or sale.⁸

2 × 0.7 W BTL audio amplifier

TDA8542TS

NOTES

Philips Semiconductors – a worldwide company

Argentina: see South America

Australia: 34 Waterloo Road, NORTH RYDE, NSW 2113,
Tel. +61 2 9805 4455, Fax. +61 2 9805 4466

Austria: Computerstr. 6, A-1101 WIEN, P.O. Box 213, Tel. +43 160 1010,
Fax. +43 160 101 1210

Belarus: Hotel Minsk Business Center, Bld. 3, r. 1211, Volodarski Str. 6,
220050 MINSK, Tel. +375 172 200 733, Fax. +375 172 200 773

Belgium: see The Netherlands

Brazil: see South America

Bulgaria: Philips Bulgaria Ltd., Energoproject, 15th floor,
51 James Bourchier Blvd., 1407 SOFIA,
Tel. +359 2 689 211, Fax. +359 2 689 102

Canada: PHILIPS SEMICONDUCTORS/COMPONENTS,
Tel. +1 800 234 7381

China/Hong Kong: 501 Hong Kong Industrial Technology Centre,
72 Tat Chee Avenue, Kowloon Tong, HONG KONG,
Tel. +852 2319 7888, Fax. +852 2319 7700

Colombia: see South America

Czech Republic: see Austria

Denmark: Prags Boulevard 80, PB 1919, DK-2300 COPENHAGEN S,
Tel. +45 32 88 2636, Fax. +45 31 57 0044

Finland: Sinikalliontie 3, FIN-02630 ESPOO,
Tel. +358 9 615800, Fax. +358 9 61580920

France: 51 Rue Carnot, BP317, 92156 SURESNES Cedex,
Tel. +33 1 40 99 6161, Fax. +33 1 40 99 6427

Germany: Hammerbrookstraße 69, D-20097 HAMBURG,
Tel. +49 40 23 53 60, Fax. +49 40 23 536 300

Greece: No. 15, 25th March Street, GR 17778 TAVROS/ATHENS,
Tel. +30 1 4894 339/239, Fax. +30 1 4814 240

Hungary: see Austria

India: Philips INDIA Ltd, Band Box Building, 2nd floor,
254-D, Dr. Annie Besant Road, Worli, MUMBAI 400 025,
Tel. +91 22 493 8541, Fax. +91 22 493 0966

Indonesia: see Singapore

Ireland: Newstead, Clonskeagh, DUBLIN 14,
Tel. +353 1 7640 000, Fax. +353 1 7640 200

Israel: RAPAC Electronics, 7 Kehilat Saloniki St, PO Box 18053,
TEL AVIV 61180, Tel. +972 3 645 0444, Fax. +972 3 649 1007

Italy: PHILIPS SEMICONDUCTORS, Piazza IV Novembre 3,
20124 MILANO, Tel. +39 2 6752 2531, Fax. +39 2 6752 2557

Japan: Philips Bldg 13-37, Kohnan 2-chome, Minato-ku, TOKYO 108,
Tel. +81 3 3740 5130, Fax. +81 3 3740 5077

Korea: Philips House, 260-199 Itaewon-dong, Yongsan-ku, SEOUL,
Tel. +82 2 709 1412, Fax. +82 2 709 1415

Malaysia: No. 76 Jalan Universiti, 46200 PETALING JAYA, SELANGOR,
Tel. +60 3 750 5214, Fax. +60 3 757 4880

Mexico: 5900 Gateway East, Suite 200, EL PASO, TEXAS 79905,
Tel. +9-5 800 234 7381

Middle East: see Italy

Netherlands: Postbus 90050, 5600 PB EINDHOVEN, Bldg. VB,
Tel. +31 40 27 82785, Fax. +31 40 27 88399

New Zealand: 2 Wagener Place, C.P.O. Box 1041, AUCKLAND,
Tel. +64 9 849 4160, Fax. +64 9 849 7811

Norway: Box 1, Manglerud 0612, OSLO,
Tel. +47 22 74 8000, Fax. +47 22 74 8341

Philippines: Philips Semiconductors Philippines Inc.,
106 Valero St. Salcedo Village, P.O. Box 2108 MCC, MAKATI,
Metro MANILA, Tel. +63 2 816 6380, Fax. +63 2 817 3474

Poland: Ul. Lukiska 10, PL 04-123 WARSZAWA,
Tel. +48 22 612 2831, Fax. +48 22 612 2327

Portugal: see Spain

Romania: see Italy

Russia: Philips Russia, Ul. Usatcheva 35A, 119048 MOSCOW,
Tel. +7 095 755 6918, Fax. +7 095 755 6919

Singapore: Lorong 1, Toa Payoh, SINGAPORE 1231,
Tel. +65 350 2538, Fax. +65 251 6500

Slovakia: see Austria

Slovenia: see Italy

South Africa: S.A. PHILIPS Pty Ltd., 195-215 Main Road Martindale,
2092 JOHANNESBURG, P.O. Box 7430 Johannesburg 2000,
Tel. +27 11 470 5911, Fax. +27 11 470 5494

South America: Al. Vicente Pinzon, 173, 6th floor,
04547-130 SÃO PAULO, SP, Brazil,
Tel. +55 11 821 2333, Fax. +55 11 821 2382

Spain: Balmes 22, 08007 BARCELONA,
Tel. +34 3 301 6312, Fax. +34 3 301 4107

Sweden: Kottbygatan 7, Akalla, S-16485 STOCKHOLM,
Tel. +46 8 632 2000, Fax. +46 8 632 2745

Switzerland: Allmendstrasse 140, CH-8027 ZÜRICH,
Tel. +41 1 488 2686, Fax. +41 1 481 7730

Taiwan: Philips Semiconductors, 6F, No. 96, Chien Kuo N. Rd., Sec. 1,
TAIPEI, Taiwan Tel. +886 2 2134 2865, Fax. +886 2 2134 2874

Thailand: PHILIPS ELECTRONICS (THAILAND) Ltd.,
209/2 Sanpavuth-Bangna Road Prakanong, BANGKOK 10260,
Tel. +66 2 745 4090, Fax. +66 2 398 0793

Turkey: Talatpasa Cad. No. 5, 80640 GÜLTEPE/ISTANBUL,
Tel. +90 212 279 2770, Fax. +90 212 282 6707

Ukraine: PHILIPS UKRAINE, 4 Patrice Lumumba str., Building B, Floor 7,
252042 KIEV, Tel. +380 44 264 2776, Fax. +380 44 268 0461

United Kingdom: Philips Semiconductors Ltd., 276 Bath Road, Hayes,
MIDDLESEX UB3 5BX, Tel. +44 181 730 5000, Fax. +44 181 754 8421

United States: 811 East Arques Avenue, SUNNYVALE, CA 94088-3409,
Tel. +1 800 234 7381

Uruguay: see South America

Vietnam: see Singapore

Yugoslavia: PHILIPS, Trg N. Pasica 5/v, 11000 BEOGRAD,
Tel. +381 11 625 344, Fax. +381 11 635 777

For all other countries apply to: Philips Semiconductors,
International Marketing & Sales Communications, Building BE-p,
P.O. Box 218, 5600 MD EINDHOVEN, The Netherlands, Fax. +31 40 27 24825

Internet: <http://www.semiconductors.philips.com>

© Philips Electronics N.V. 1997

SCA56

All rights are reserved. Reproduction in whole or in part is prohibited without the prior written consent of the copyright owner.

The information presented in this document does not form part of any quotation or contract, is believed to be accurate and reliable and may be changed without notice. No liability will be accepted by the publisher for any consequence of its use. Publication thereof does not convey nor imply any license under patent- or other industrial or intellectual property rights.

Printed in The Netherlands

545102/25/02/pp20

Date of release: 1998 Mar 25

Document order number: 9397 750 03351

Let's make things better.

**Philips
Semiconductors**



PHILIPS