

PIF / SIF + ATT IC FOR TV / VTR

FEATURES

PIF section

- RF-Pre Amp. less by high input sensitivity
- 3-Stage IF amplifier with variable gain
- High-Speed response AGC with dual time constants
- Single end AFT output with defeat function
- Delayed RF AGC output (Reverse AGC)
- Output with white / black noise inverter
- Output without white / black noise inverter
- Video mute switch

SIF section

- 3-stage limiter amplifier
- Quadrature-type detection circuit
- Use of a ceramic discriminator device makes the SIF circuit adjustment-free
- Sound mute switch
- N.F. audio amplifier
- DC ATT control

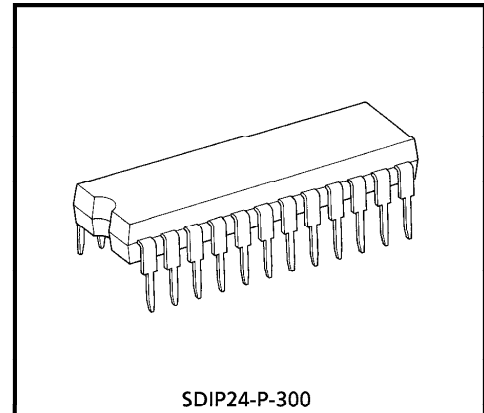

Weight : 1.22g (Typ.)

BLOCK DIAGRAM

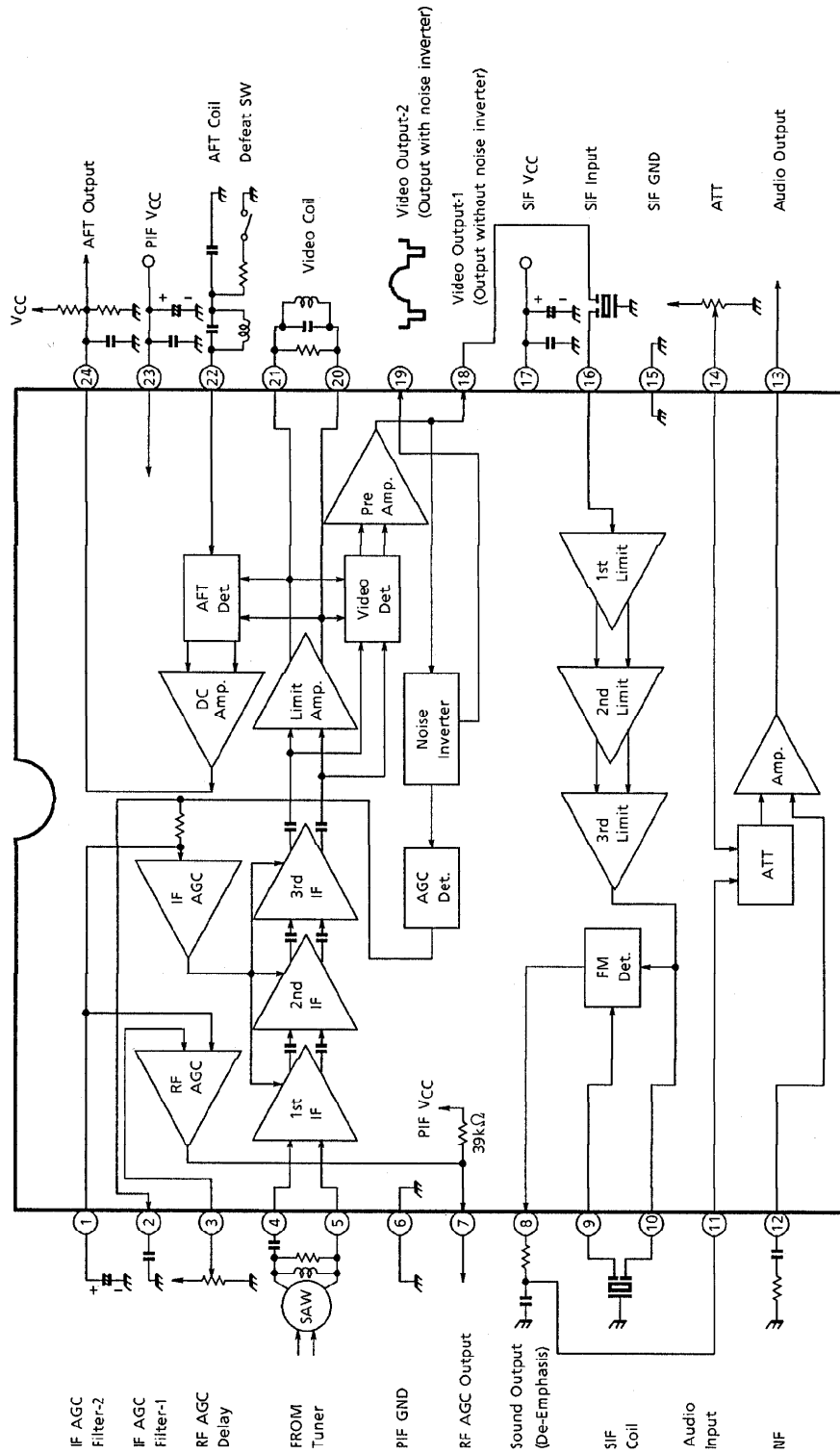

TA8701AN - 2

TERMINAL FUNCTION

PIN No.	PIN NAME	FUNCTION	INTERFACE CIRCUIT
1 2	AGC Filter	This filter is a dual time constant system to speed up AGC. By connecting the primary filter terminal of pin 2 to GND, the picture muting is executed.	
3	AGC Delay	This terminal adjusts the delay point of RF AGC by varying the reference voltage of comparator.	
4 5	PIF Input	This is an input terminal of PIF signal using an emitter follower. The input impedance is typical 2.5kΩ, 4pF.	
6	PIF GND	GND pin for the PIF amplifier. Connect a capacitor between pins 23 and 6.	—
7	RF AGC Output	Output pin for RF-AGC supplied to the tuner. (A 39kΩ resistor is connected internally between pin 7 and the internal power supply pin.)	

PIN No.	PIN NAME	FUNCTION	INTERFACE CIRCUIT
8	FM Det Output (De-emphasis)	This is an output terminal of FM detector circuit. (Supply this signal to the de-emphasis circuit.)	
9 10	SIF Coil	This terminal connects FM detector Coil. Use of a ceramic discriminator device makes the SIF circuit adjustment-free. By connecting pin 9 to GND, the Audio muting is executed.	
11	Audio Input	Sound amplifier Input terminal.	
12	NF	Sound amplifier negative feedback terminal.	
13	Audio Output	Sound Signal Output terminal.	

PIN No.	PIN NAME	FUNCTION	INTERFACE CIRCUIT
14	ATT	Sound amplifier gain control terminal.	
15	SIF GND	GND pin for the SIF amplifier. Connect a capacitor between pins 15 and 17.	—
16	SIF Input	Limiter amplifier input terminal.	
17	SIF V _{CC}	V _{CC} pin for the SIF amplifier. Connect a capacitor between pins 15 and 17.	—
18	Video Signal Output-1 (N.I. OFF)	This is an output terminal of video output. By connecting Pin 2 to GND, a muting is executed. Output Signal supplied to the sound IF (SIF) circuit. (Example for diversity antenna circuit.)	
19	Video Signal Output-2 (N.I. ON)	This is an output terminal of video output. By connecting Pin 2 to GND, a muting is executed.	

PIN No.	PIN NAME	FUNCTION	INTERFACE CIRCUIT
20 21	Video Coil	This terminal connects video detector Coil.	
22	AFT Coil	Supply a control signal by single end. This method is that the phase difference is treated as current and voltage is converted by an external resistor. There-fore, this can be connected to AFT using only one pin. By connecting a resistor of 5.1kΩ to GND, an AFT defeat can be executed.	
23	PIF VCC	VCC Pin for the PIF amplifier. Connect a capacitor between pins 6 and 23.	—
24	AFT Output	This is an output terminal of AFT.	

MAXIMUM RATINGS (Ta = 25°C)

CHARACTERISTIC	SYMBOL	RATING	UNIT
Supply Voltage	V _{CC}	15	V
Power Dissipation	P _D (Note)	1.4	W
Operating Temperature	T _{opr}	- 20~65	°C
Storage Temperature	T _{stg}	- 55~150	°C

(Note) When using the device at above Ta = 25°C, decrease the power dissipation by 11.2mW for each increase of 1°C.

RECOMMENDED SUPPLY VOLTAGE

PIN No.	PIN NAME	MIN.	TYP.	MAX.	UNIT
17	PIF V _{CC}	8.1	9.0	9.9	V
23	SIF V _{CC}	8.1	9.0	9.9	V

ELECTRICAL CHARACTERISTICS

DC CHARACTERISTICS (Unless otherwise specified, V_{CC} = 9V, Ta = 25°C)

CHARACTERISTIC	SYMBOL	TEST CIR-CUIT	TEST CONDITION	MIN.	TYP.	MAX.	UNIT
Supply Current	I _{CC}	1	—	29	43	56	mA
Terminal Voltage	Pin 3	V ₃	SW ₂ : b	5.7	6.2	6.7	V
	Pin 4	V ₄	—	3.5	4.0	4.5	
	Pin 5	V ₅	—	3.5	4.0	4.5	
	Pin 7	V ₇ (1)	SW ₁ : a SW ₂ : c	8.8	—	—	
		V ₇ (2)	SW ₁ : b SW ₂ : a	—	—	0.5	
	Pin 8	V ₈	SW ₃ : b	3.3	3.9	4.5	
	Pin 9	V ₉	SW ₃ : a	2.2	2.7	3.2	
	Pin 10	V ₁₀	—	3.2	3.7	4.2	
	Pin 11	V ₁₁	—	3.0	3.5	4.0	
	Pin 12	V ₁₂	—	5.7	6.2	6.7	
	Pin 13	V ₁₃	SW ₄ : b	4.4	4.9	5.4	
	Pin 14	V ₁₄	SW ₄ : a	2.0	2.5	3.0	
	Pin 16	V ₁₆	—	2.5	3.0	3.5	
	Pin 18	V ₁₈	—	4.2	4.7	5.2	
	Pin 19	V ₁₉	—	4.2	4.7	5.2	
	Pin 20	V ₂₀	—	5.8	6.3	6.8	
	Pin 21	V ₂₁	—	5.8	6.3	6.8	
	Pin 22	V ₂₂	SW ₅ : a	2.3	2.8	3.3	
Pin 24	V ₂₄	SW ₅ : b	2.5	4.0	5.5		

AC CHARACTERISTICS (Unless otherwise specified, $V_{CC} = 9V$, $T_a = 25^\circ C$)
PIF section (When using the specified video coil)

CHARACTERISTIC	SYMBOL	TEST CIR-CUIT	TEST CONDITION	MIN.	TYP.	MAX.	UNIT
Input Sensitivity	V_{in} MIN	2	(Note 1)	36	41	46	$dB\mu V$
Maximum Input Level	V_{in} MAX	2	(Note 2)	100	110	—	$dB\mu V$
IF AGC Range	ΔA	2	—	50	62	—	dB
Differential Gain	DG	3	(Note 3)	—	—	8	%
Differential Phase	DP			—	—	6	°
No-signal Output Level	V_{14}, V_{15}	2	(Note 4)	4.0	4.6	5.2	V
Sync. Tip Level	V_{SYNC}	2	(Note 5)	2.0	2.3	2.6	V
Video Output Amplitude	V_{OUT}	2	(Note 6)	1.7	2.0	2.3	V_{p-p}
White Noise Inverter Level	V_{WTH}	2	(Note 7)	—	5.0	—	V
White Noise Clamp Level	V_{WCL}			—	3.8	—	
Black Noise Inverter Level	V_{BTH}			0.9	1.2	1.5	
Black Noise Clamp Level	V_{BCL}			3.2	3.5	3.8	
Carrier Wave Rejection Ratio	C_L	4	(Note 8)	40	—	—	dB
Harmonic Rejection Ratio	I_{2nd}	4	(Note 9)	40	—	—	dB
AFT Sensitivity	$\Delta F / \Delta V$	2	(Note 10)	—	20	30	kHz / V
AFT Output Voltage	Min. V_L	2	—	—	0.1	0.5	V
	Max. V_U			8.4	8.7	—	
Intermodulation	I_{920}	4	(Note 11)	30	38	—	dB

SIF section (When using the specified SIF coil)

CHARACTERISTIC	SYMBOL	TEST CIR-CUIT	TEST CONDITION	MIN.	TYP.	MAX.	UNIT
FM Detector Output Level	V_{OD}	5	(Note 12)	350	550	750	mV_{rms}
Limiting Sensitivity	V_{INLIM}	5	(Note 13)	—	40	50	$dB\mu V$
AM Suppression Ratio	AMR	5	(Note 14)	40	—	—	dB
– 3dB Bandwidth	$\pm \Delta f_G$	5	(Note 15)	60	80	—	kHz
Distortion Bandwidth (1.5%)	$\pm \Delta f_D$	5	(Note 16)	50	70	—	kHz
ATT AC Gain	G_V (ATT)	2	(Note 17)	8	10	12	dB
ATT Maximum Attenuation	ATT MAX	2	(Note 18)	75	—	—	dB
Audio Amp. AC Gain	G_V (AF)	2	(Note 19)	15	17	19	dB

TEST CONDITIONS

(Note 1) Input sensitivity

PIF input (Pin 4) : $f_o = 58.75\text{MHz}$, $f_m = 15.75\text{kHz}$, 30% AM, $84\text{dB}\mu\text{V}$.

Gradually reduce the input level. Measure the input level when the detection output at video output (Pin 19-a) will be -3dB .

(Note 2) Maximum input level

PIF input (Pin 4) : Input same as Note 1.

Gradually raise the input level. Measure the input level when the detection output at video output (Pin 19-a) is at the noise inverter threshold.

(Note 3) Differential gain / Differential phase

PIF input (Pin 4) : $f_o = 58.75\text{MHz}$, Standard television signal ($V/S = 10 : 4$ ramp waveform), 87.5% AM, $84\text{dB}\mu\text{V}$.

IF AGC = Free.

Measure the differential gain and differential phase with a vector scope. (Pin 19-b)

(Note 4) No-signal output level

PIF input (Pin 4) : No input. 2nd AGC terminal (Pin 1) : GND, Measure DC voltage at video output (Pin 19-a).

(Note 5) Sync. Tip level

PIF input (Pin 4) : Input same as Note 3. Measure Sync. Tip DC voltage at video output (Pin 19-b).

(Note 6) Video output amplitude

PIF input (Pin 4) : Input same as Note 3. Measure amplitude level at video output (Pin 19-b).

(Note 7) Noise inverter

PIF input (Pin 4) : $f_o = 57\sim 65\text{MHz}$ (Sweep Signal), $84\text{dB}\mu\text{V}$.

Connect monitor scope to video output (Pin 19-b).

Measure the 2nd AGC terminal (Pin 1) voltage and fix the terminal to that voltage using the external power supply.

Then, 2nd AGC Voltage variable when a waveform like that in the accompanying diagram is output.

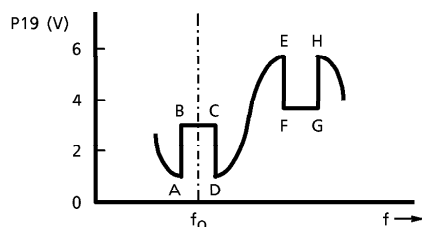

AP : Black Noise Inverter Level.

BC : Black Noise Clamp Level.

EH : White Noise Inverter Level.

FG : White Noise Clamp Level.

(Note 8) Carrier wave rejection ratio

PIF input (Pin 4) : $f_o = 58.75\text{MHz}$, $f_m = 15.75\text{kHz}$, 78% AM, $84\text{dB}\mu\text{V}$.

Add the voltage 2nd AGC terminal (Pin 1), So that the video output (Pin 19-b) can be $2V_{p-p}$.

Calculate the following equation by setting the modulation to 「0」 and measuring the output carrier level.

$$C_L = 20 \log \frac{2.0}{V_{MOD} \text{「0」} (V_{p-p})} \text{ [dB]}$$

(Note 9) Harmonic rejection ratio

Measure as is Note 8, above, and calculate the secondary harmonic level (117.5MHz component) at video output (Pin 19-b).

(Note 10) AFT sensitivity

PIF input (Pin 4) : $f_o = 58.75\text{MHz}$, $84\text{dB}\mu\text{V}$, CW.

Input the above signal and adjust the AFT coil so that the AFT output pin (Pin 24) voltage is 4.5V.

Measure the output voltage differential (ΔV) of the AFT output pin when the frequency is raised by 20kHz. Then, calculate the ratio using the following formula.

$$\frac{\Delta f}{\Delta V} = \frac{20}{\Delta V} \text{ [kHz / V]}$$

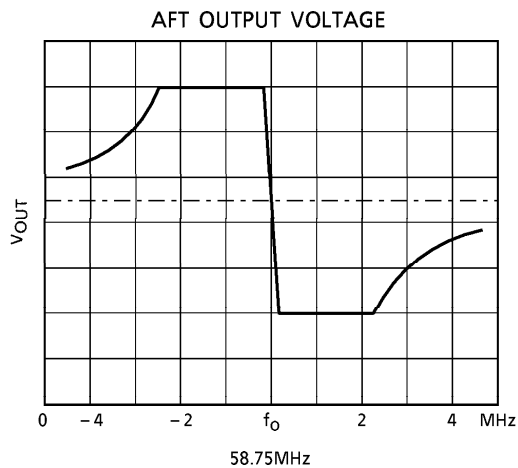

(Note 11) Intermodulation

PIF input (Pin 4) : Input the following composite signals to the PIF input.

- (1) SG1 : 58.75MHz (P) 84dB μ V
- (2) SG2 : 54.25MHz (S) 74dB μ V
- (3) SG3 : 55.17MHz (C) 74dB μ V

Monitor the video output (Pin 19-b) detection output waveform. Apply external voltage to the 2nd AGC terminal (Pin 1) So that the waveform's lowest level matches the sync. Tip level.

Using a spectrum analyzer, measure the difference between the level of the chroma signal component and 920kHz signal component.

(Note 12) FM detection output

SIF input (Pin 16) : $f_o = 4.5\text{MHz}$, $f_m = 400\text{Hz}$, 25kHz/devi, 100dB μ V.

Measure the sound detection output of the sound output terminal (Pin 8).

(Note 13) Limiting sensitivity

SIF input (Pin 16) : Input same as Note 12. Gradually reduce the input signal. Measure the input level when the sound detection output of the sound output terminal (Pin 8) will be -3dB.

(Note 14) AM Suppression ratio

SIF input (Pin 16) : $f_o = 4.5\text{MHz}$, 84dB μ V.

Measure the sound detection output level of the sound output terminal (Pin 8) when the above signals are modulated as follows. Calculate The ratio.

- (1) AM modulation : $f_m = 400\text{Hz}$, 30%
- (2) FM modulation : $f_m = 400\text{Hz}$, 25kHz/devi

$$\text{AMR} = 20\log \left[\frac{\text{with FM modulation (mV}_{\text{rms}})}{\text{with AM modulation (mV}_{\text{rms}})} \right] [\text{dB}]$$

(Note 15) -3dB bandwidth

SIF input (Pin 16) : $f_o = 4.5\text{MHz}$, $f_m = 400\text{Hz}$, 7.5kHz/devi, 100dB μ V.

- (1) f_{AFh} : Gradually raise the frequency. Measure the input frequency when the sound detection output of the sound output terminal will be -3dB.
- (2) f_{AFl} : Gradually lower the frequency. Measure the input frequency when the sound detection output of the sound output terminal will be -3dB.

$$\text{-3dB bandwidth} = (f_{\text{AFh}} - f_{\text{AFl}}) [\text{kHz}]$$

(Note 16) Distortion bandwidth (1.5%)

SIF input (Pin 16) : Input same as Note 15.

- (1) f_{DAFh} : Gradually raise the frequency. Measure the Input frequency when the sound distortion ratio of the sound output terminal will be 1.5%.
- (2) f_{DAFl} : Gradually lower the frequency. Measure the input frequency when the sound distortion ratio of the sound output terminal will be 1.5%.

$$\text{Distortion bandwidth} = (f_{DAFh} - f_{DAFl}) \text{ [kHz]}$$

(Note 17) ATT AC gain

Audio input (Pin 11) : $f = 1\text{kHz}$, $0.1V_{p-p}$.

Measure the negative feedback terminal (Pin 12) output level.

Calculate the ratio using the following formula.

$$G_V (\text{ATT}) = 20 \log \frac{(\text{Pin 12}) V_{p-p}}{(0.1) V_{p-p}} \text{ [dB]}$$

(Note 18) ATT maximum attenuation

Audio input (Pin 11) : $f = 1\text{kHz}$, $0.5V_{p-p}$.

ATT terminal volume is Max and Min. (Audio Control : Pin 14)

Measure the negative feedback terminal (Pin 12) output level.

Calculate the ratio using the following formula.

$$\text{ATT MAX} = 20 \log \frac{(\text{Volume Max}) V_{p-p}}{(\text{Volume Min}) V_{p-p}} \text{ [dB]}$$

(Note 19) Audio amp. AC gain

Audio input (Pin 11) : $f = 1\text{kHz}$, $0.1V_{p-p}$.

ATT terminal volume is Max. (Audio Control : Pin 14)

Measure the Audio output terminal (Pin 13) output level.

Calculate the ratio using the following formula.

$$G_V (\text{AF}) = 20 \log \frac{(\text{Pin 13}) V_{p-p}}{(0.1) V_{p-p}} \text{ [dB]}$$

TEST CIRCUIT 1
DC characteristic

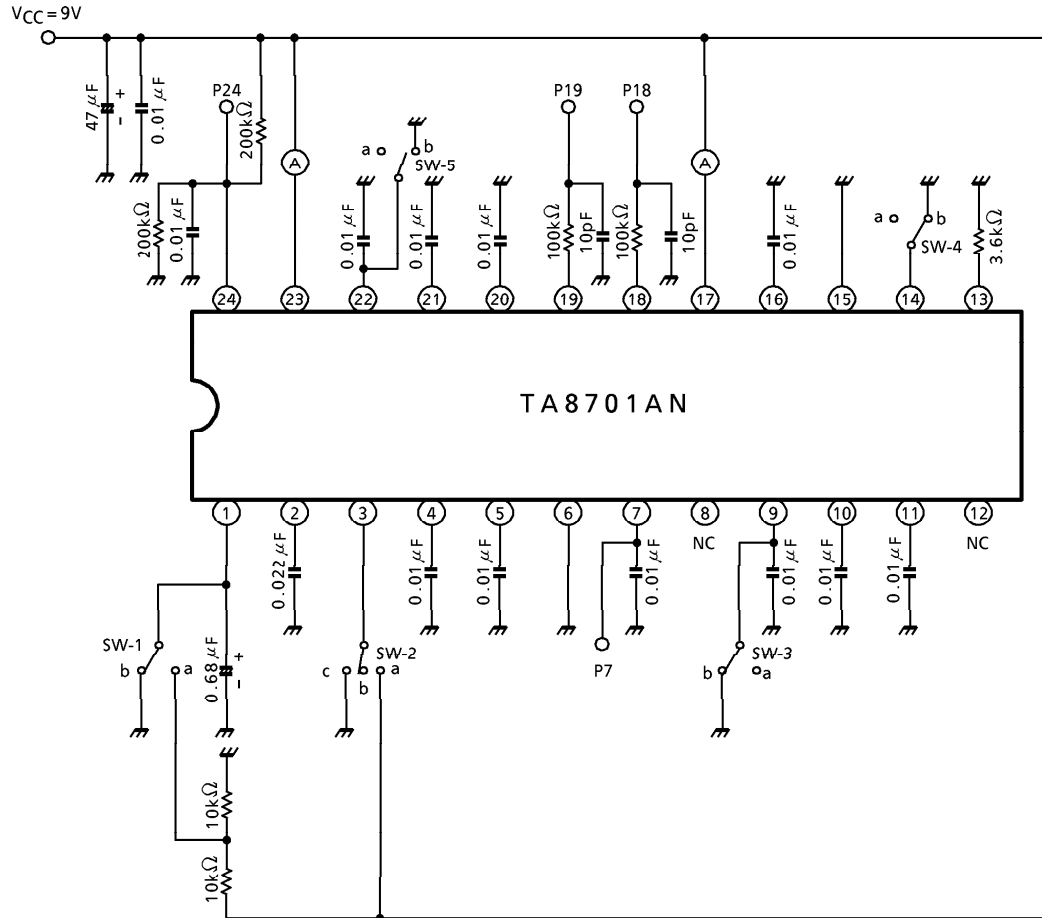

TEST CIRCUIT 2
AC characteristic

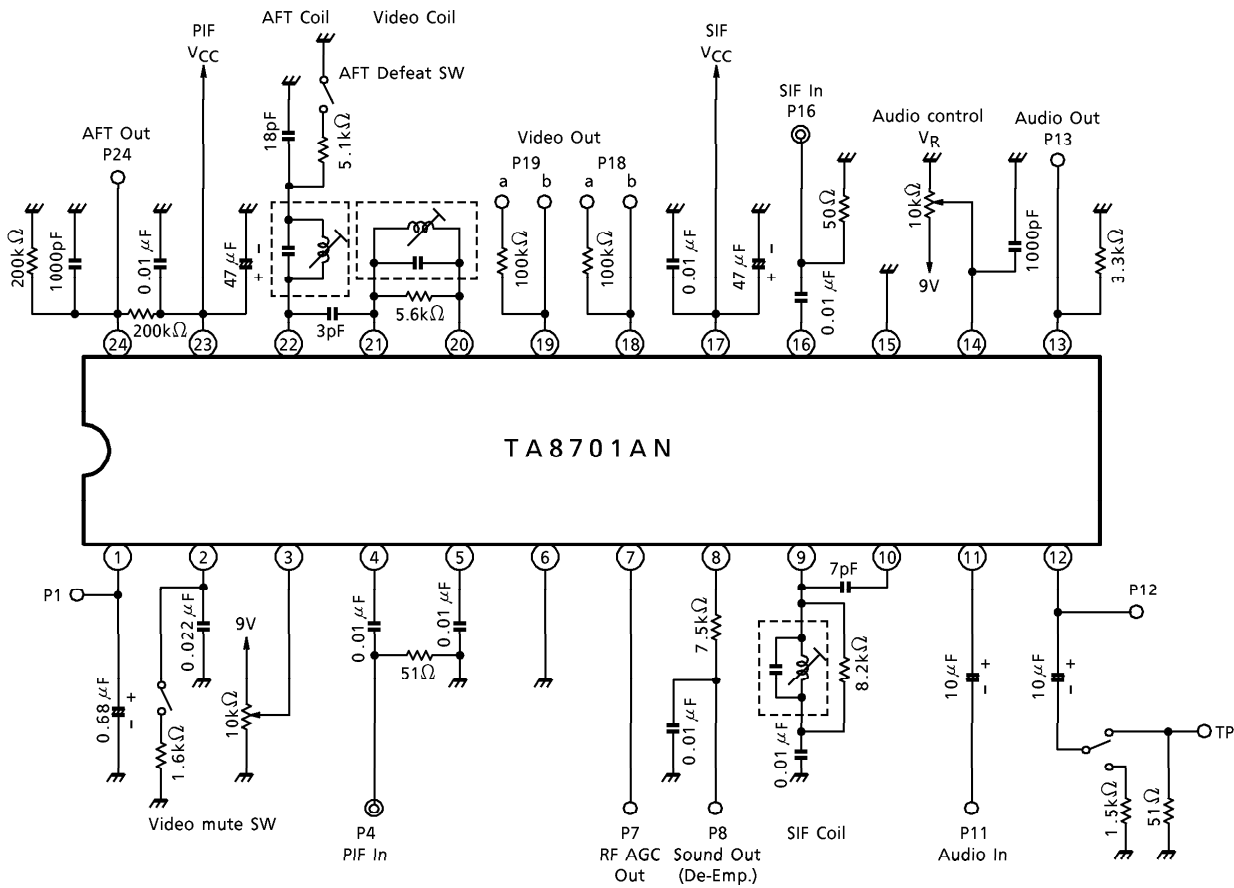

COIL	JAPAN	USA
VIDEO	TRF1060D	TRF1066
AFT	TRF1059D	TRF1066
SIF	TRF6010D	TRF6010D

TEST CIRCUIT 3

DG / DP

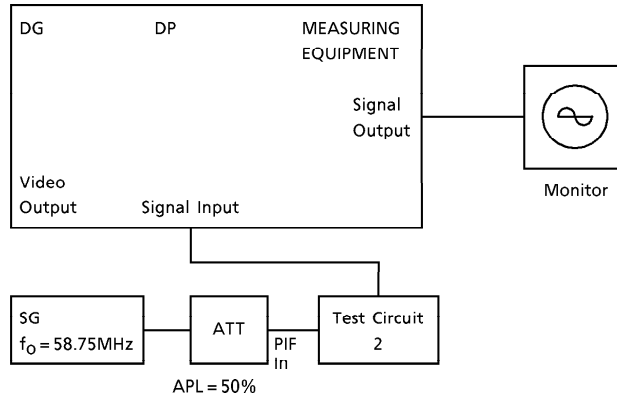

TEST CIRCUIT 4

Carrier wave rejection ratio, harmonic rejection ratio and intermodulation

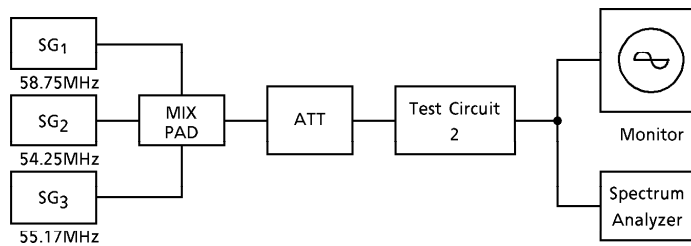

TEST CIRCUIT 5

$V_{IN(LIM)}$, AMR, V_{OD} , Δf_G , Δf_D

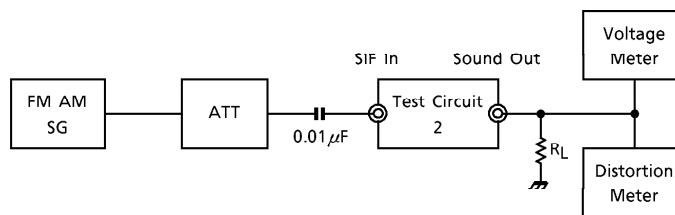

RF-AGC DELAY POINT TEMPERATURE CHARACTERISTICS

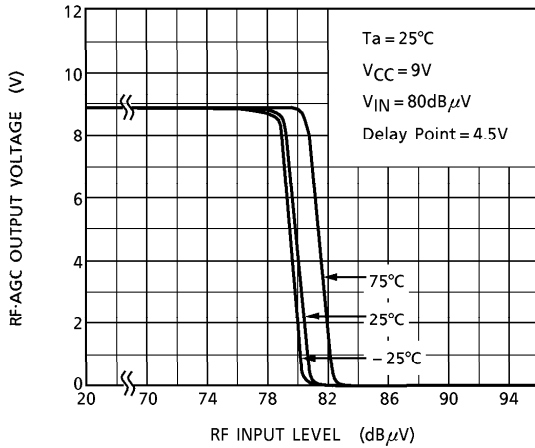

SIF / AMR CHARACTERISTICS

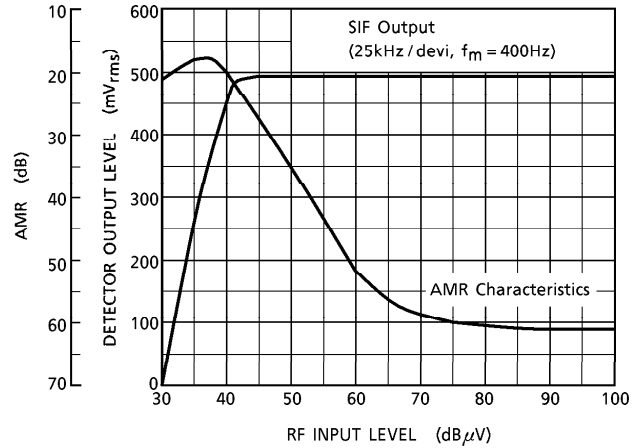

SIF BANDWIDTH CHARACTERISTICS

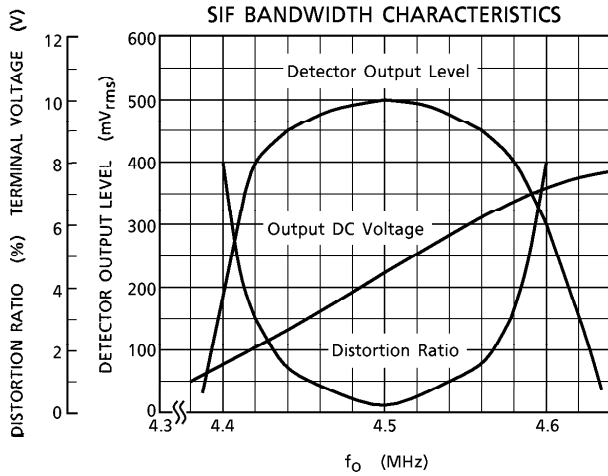

ATT CONTROL CHARACTERISTICS

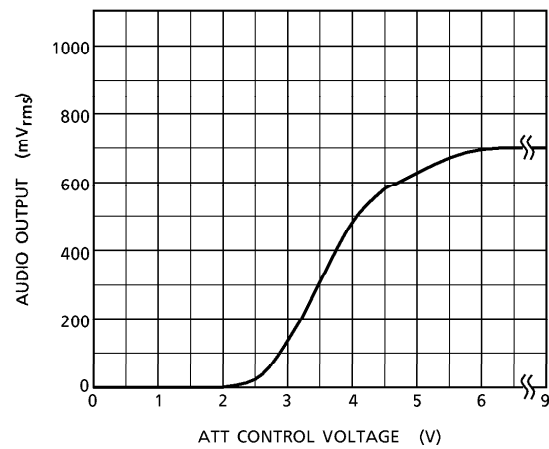

COIL	USA	JAPAN
SAW	TRF1070	TRF1058
VIDEO	TRF1066	TRF1060D
AFT	TRF1066	TRF1059D
SIF	TRF6010D	TRF6010D

APPLICATION CIRCUIT

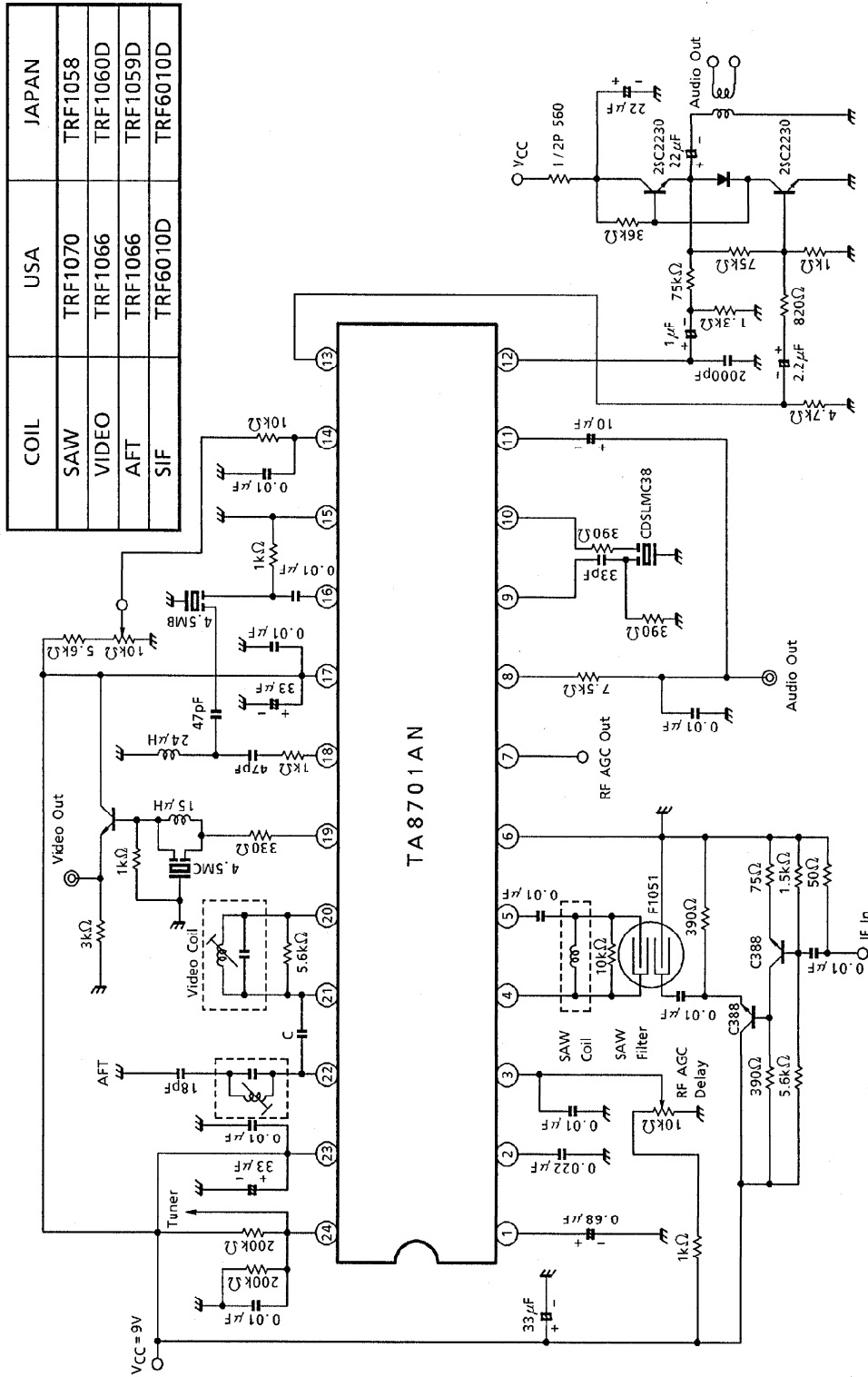

TA8701AN - 17

OUTLINE DRAWING
SDIP24-P-300

Unit : mm

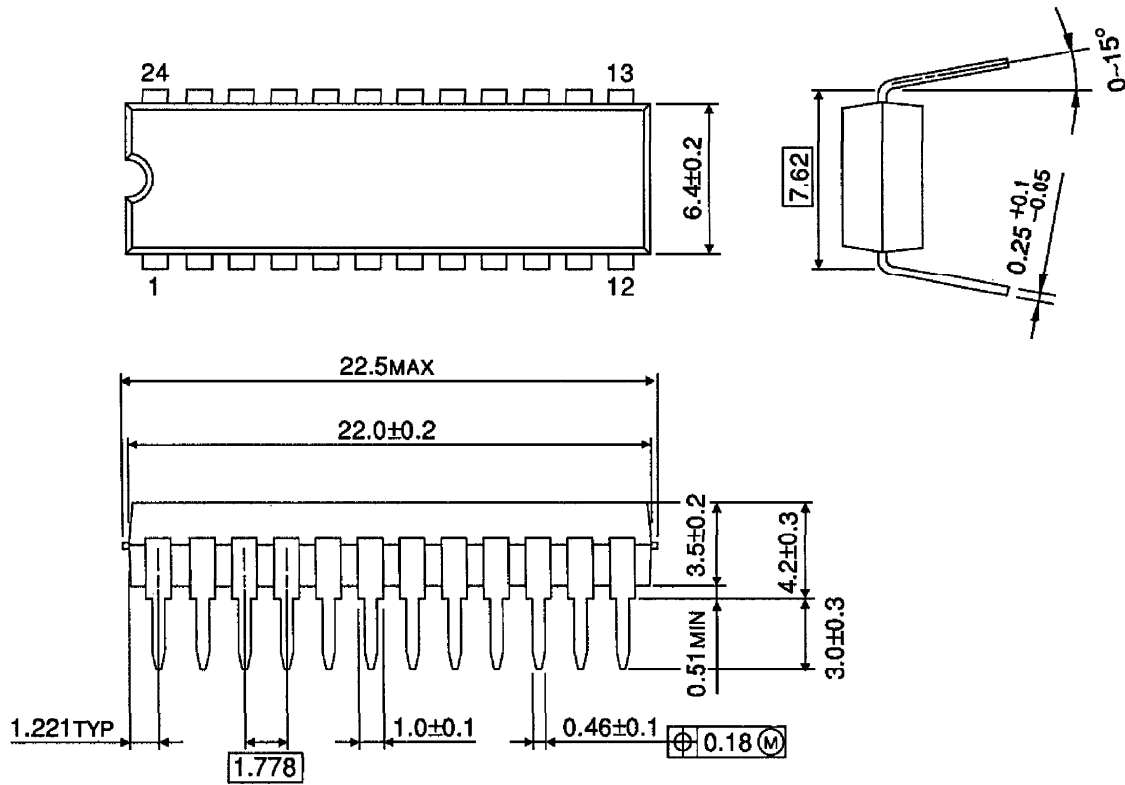

Weight : 1.22g (Typ.)

TA8701AN - 18*
1996 - 4 - 22
TOSHIBA CORPORATION