

DUAL AUDIO POWER AMPLIFIER

The TA8200AH is dual audio power amplifier for consumer applications.

This IC provides an output power of 13 watts per channel (at $V_{CC} = 28V$, $f = 1kHz$, $THD = 10\%$, $R_L = 8\Omega$). It is suitable for power amplifier of TV and home stereo.

FEATURES

- High Output Power : $P_{Out} = 13W / \text{channel (Typ.)}$
($V_{CC} = 28V$, $R_L = 8\Omega$, $f = 1kHz$, $THD = 10\%$)
- Low Noise : $V_{NO} = 0.14mV_{rms}$ (Typ.)
($V_{CC} = 28V$, $R_L = 8\Omega$, $G_v = 34dB$, $R_g = 10k\Omega$, $BW = 20Hz \sim 20kHz$)
- Very Few External Parts.
- Built in Audio Muting Circuit.
- Built in Thermal Shut Down Protector Circuit.
- Operating Supply Voltage Range : $V_{CC(opr)} = 10 \sim 37V$ ($T_a = 25^\circ C$)

BLOCK DIAGRAM

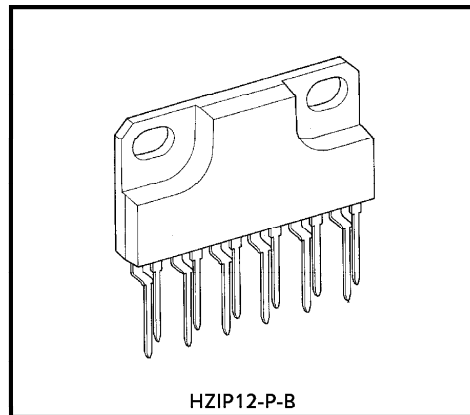
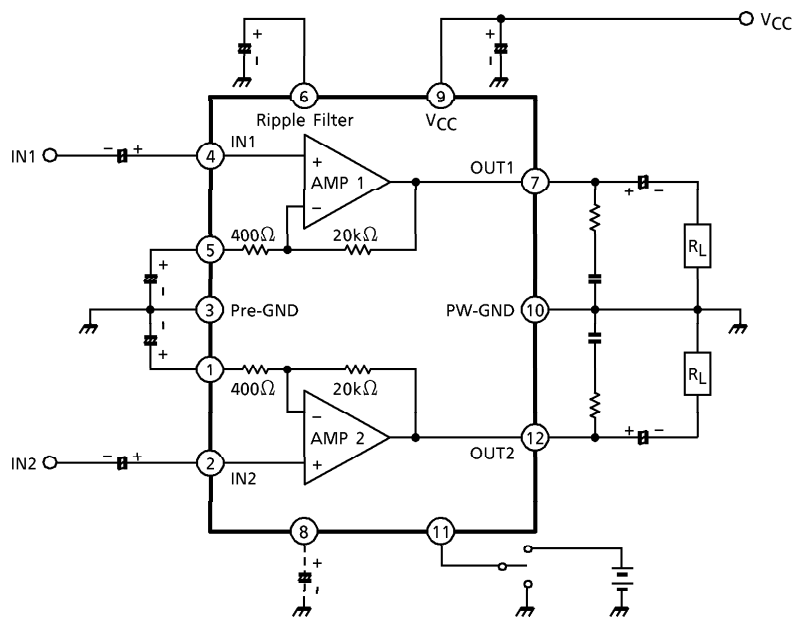

HZIP12-P-B

Weight : 4.04g (Typ.)

APPLICATION INFORMATION

(1) Voltage gain

The closed loop voltage gain is determined by R_1 , R_2 .

$$G_V = 20 \log \frac{R_1 + R_2}{R_2} \text{ (dB)}$$

$$= 20 \log \frac{20\text{k}\Omega + 400\Omega}{400\Omega} = 34 \text{ (dB)}$$

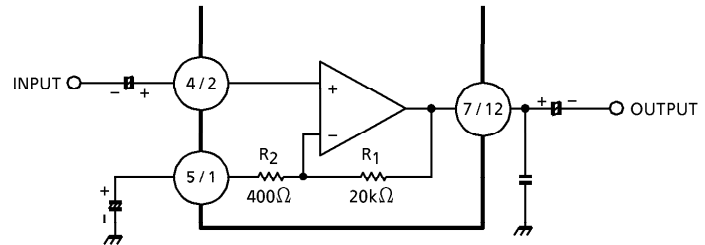

Fig.1

(2) Amplifier with gain < 34dB

$$G_V = 20 \log \frac{R_1 + R_2 + R_3}{R_2 + R_3} \text{ (dB)}$$

When $R_3 = 220\Omega$

$G_V \approx 30 \text{ (dB)}$
is given.

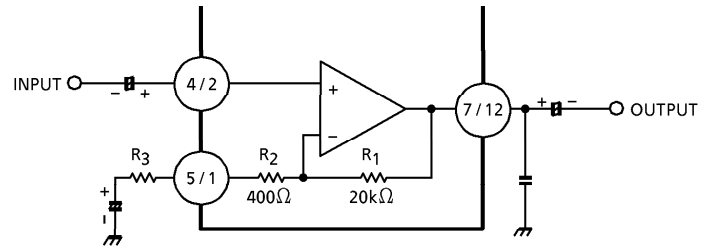

Fig.2

2. Muting

(1) Audio muting

This IC is possible to make audio muting operation by using ⑪pin muting terminal.

In Fig.3, the equivalent circuit in the muting circuit section is shown.

By means of reducing the voltage of ⑪pin down to 2.8V or less in Fig.3, Q₁ is turned ON and the base voltage of Q₂ in the differential circuit fabricated with Q₂ and Q₃.

Therefore, with the voltage reduction of ⑪pin, the input circuits of dummy of input terminal and that in the dotted line operate and cut-off the input signal.

After muting, the bias circuit continues its operation and the power supply current of quiescent time.

⑧pin, the capacitor terminal for reducing the pop noise can reduce the pop noise through making the time constant longer by means of inserting the capacitor externally.

In the case this terminal is not used, short ⑧pin with ⑪pin.

The voltage of ⑪pin set up to 4V or more.

(2) IC internal muting at V_{CC} OFF

When V_{CC}=8V or less at V_{CC} off, the detection circuit at V_{CC} off is operated. And the base voltage of Q₁ is reduced and the muting operation is mode.

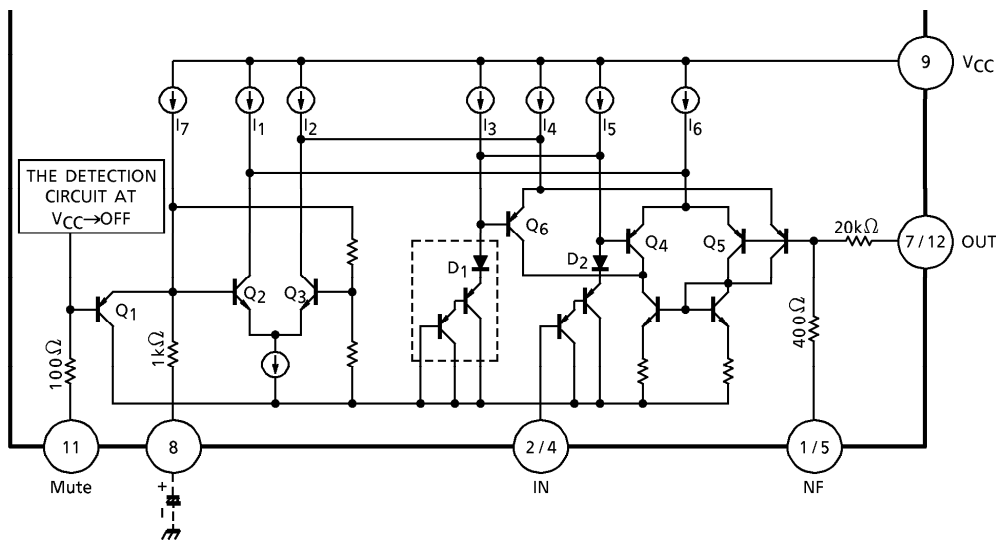
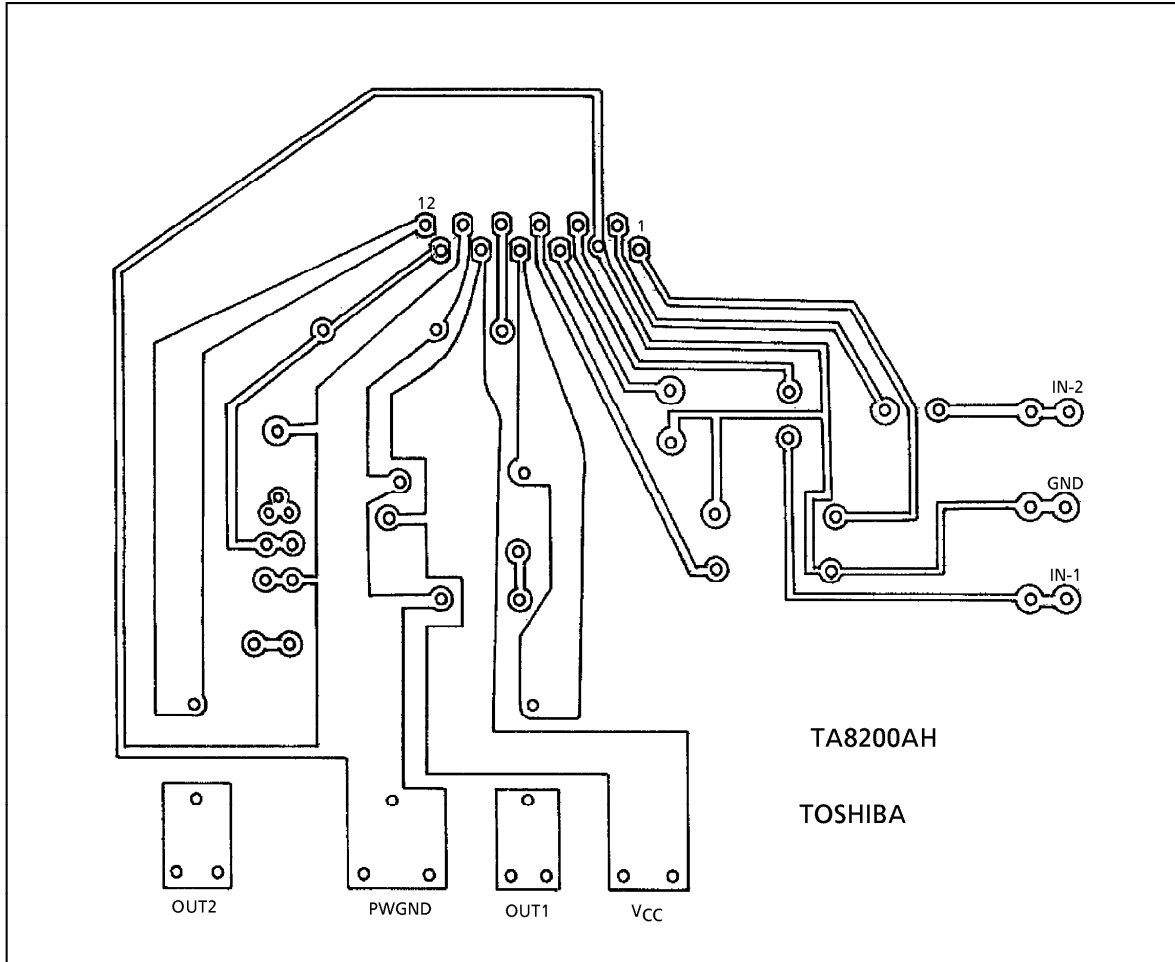

Fig.3

(3) Standard PCB TA8200AH



(BOTTOM VIEW)

MAXIMUM RATINGS (Ta = 25°C)

CHARACTERISTIC	SYMBOL	RATING	UNIT
Supply Voltage	V _{CC}	37	V
Output Current (Peak/Ch)	I _O (peak)	2.5	A
Power Dissipation	P _D (Note)	25	W
Operating Temperature	T _{opr}	-20~75	°C
Storage Temperature	T _{stg.}	-55~150	°C

(Note) Derated above Ta = 25°C in the proportion of 200mW/°C.

ELECTRICAL CHARACTERISTICS

(Unless otherwise specified, V_{CC} = 28V, R_L = 8Ω, R_G = 600Ω, f = 1kHz, Ta = 25°C)

CHARACTERISTIC	SYMBOL	TEST CIRCUIT	TEST CONDITION	MIN.	TYP.	MAX.	UNIT
Quiescent Current	I _{CCQ}	—	V _{in} = 0	—	50	105	mA
Output Power	P _{out} (1)	—	THD = 10%	10	13	—	W
	P _{out} (2)	—	THD = 1%	—	10	—	
Total Harmonic Distortion	THD	—	P _{out} = 2W	—	0.04	0.2	%
Voltage Gain	G _V	—	V _{out} = 0.775V _{rms} (0dBm)	32.5	34.0	35.5	dB
Input Resistance	R _{IN}	—	—	—	30	—	kΩ
Ripple Rejection Ratio	R.R.	—	R _G = 0, f _{ripple} = 100Hz V _{ripple} = 0.775V _{rms} (0dBm)	-40	-50	—	dB
Output Noise Voltage	V _{no}	—	R _G = 10kΩ, BW = 20Hz~20kHz	—	0.14	0.3	mV _{rms}
Cross Talk	C.T.	—	R _G = 10kΩ, V _{out} = 0.775V _{rms} (0dBm)	—	-70	—	dB
Muting Threshold Voltage	V _{th} ①	—	—	2.6	2.8	—	V

TYP. DC VOLTAGE OF EACH TERMINAL (V_{CC} = 28V, Ta = 25°C)

TERMINAL No.	1	2	3	4	5	6	7	8	9	10	11	12
DC Voltage (V)	1.6	20m	GND	20m	1.6	9.4	13.0	5.0	V _{CC}	GND	2.8	13.0

TEST CIRCUIT

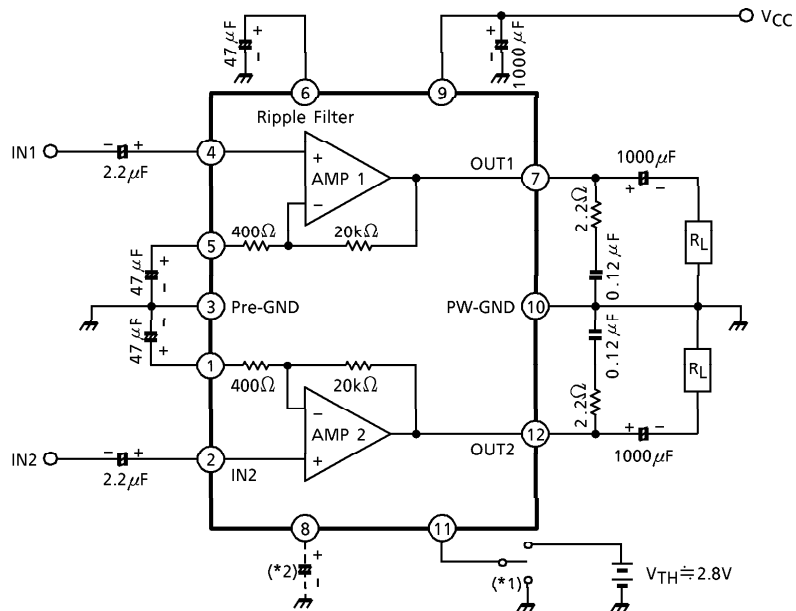

(*1) Mute on at ⑪pin low

$V_{TH} = 2.8V$ (Typ.), $V_{CC} = 28V$, $T_a = 25^\circ C$

(*2) The capacitor for reducing POP noise at mute ON.

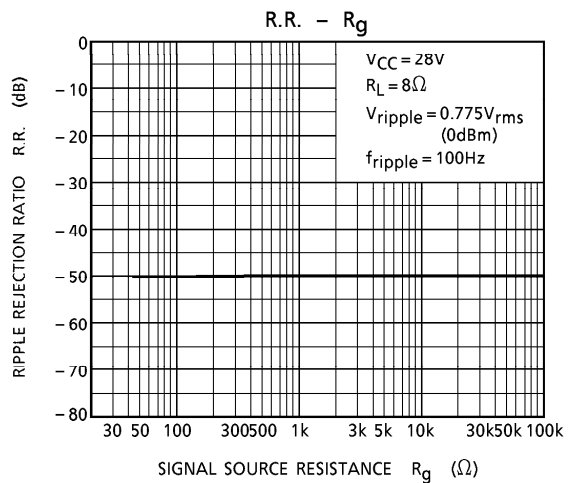
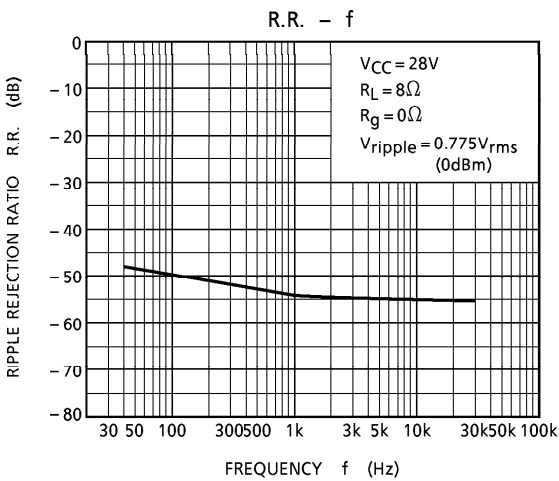
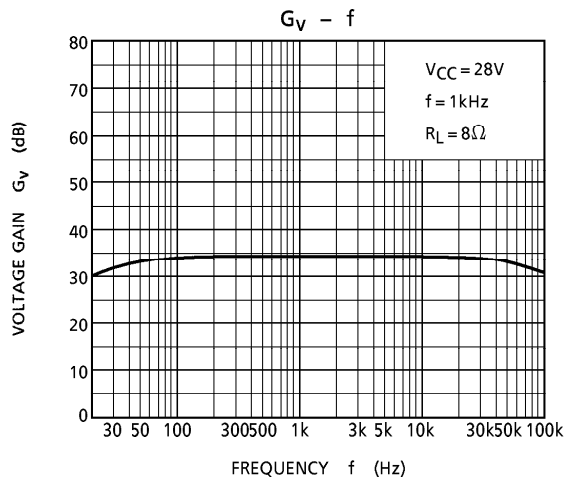
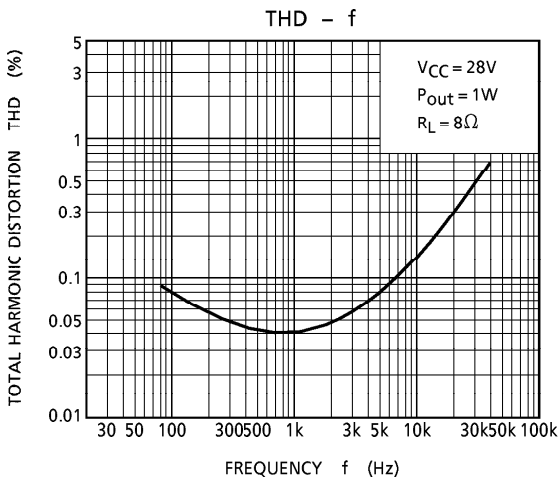
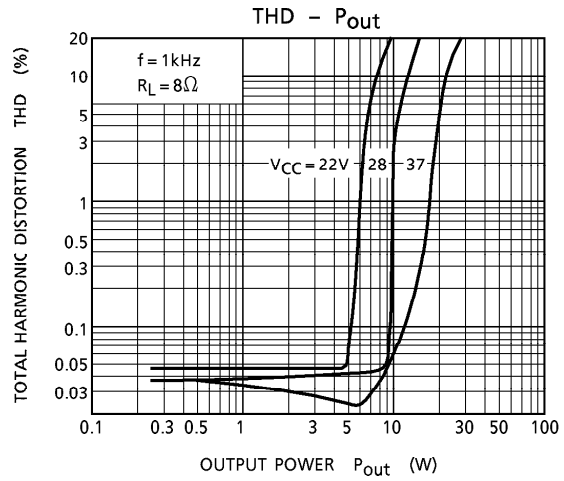
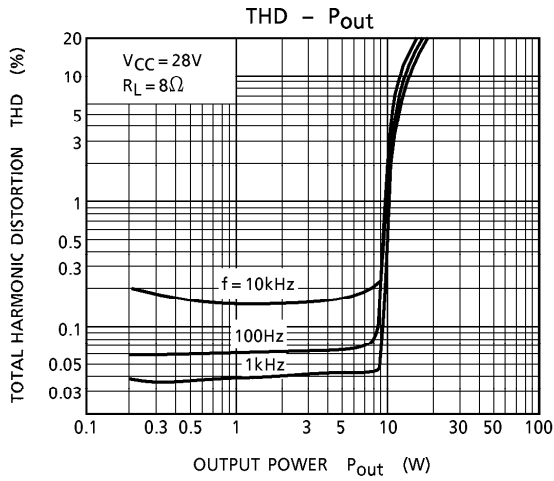

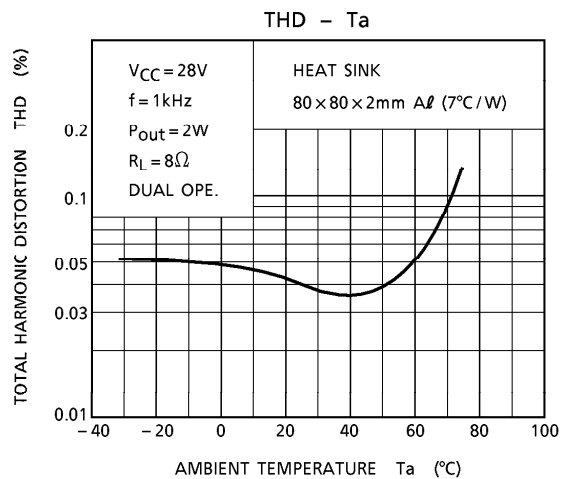
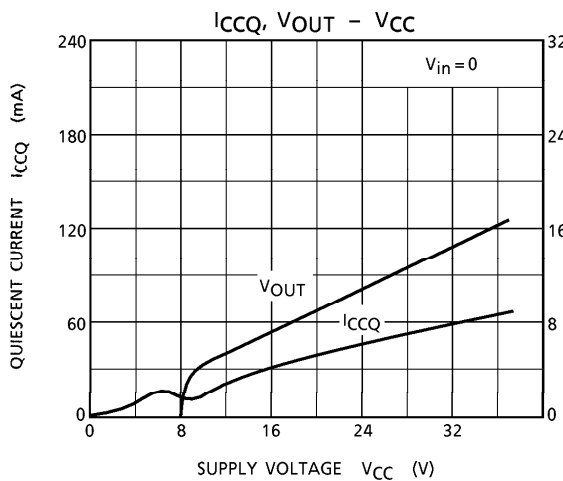
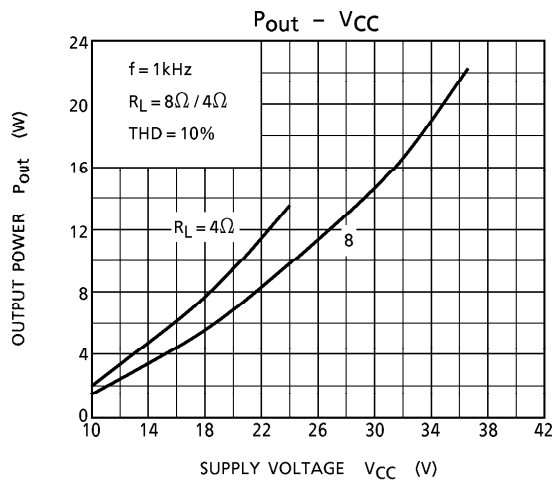
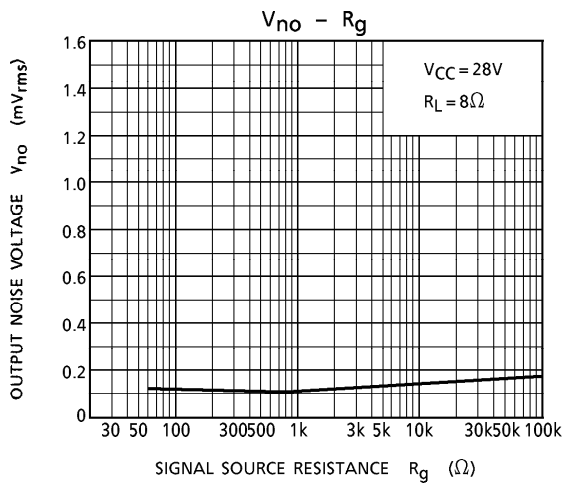
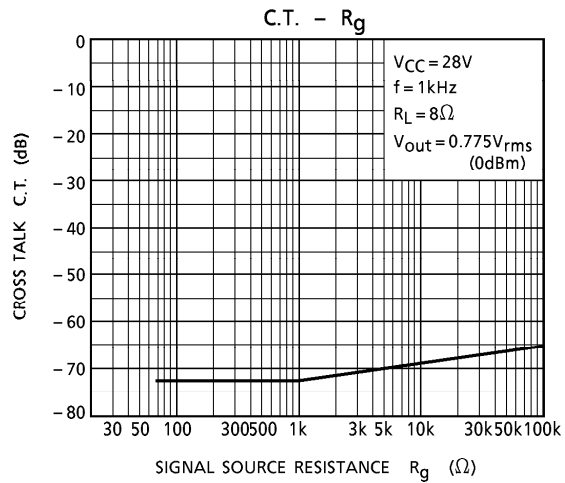
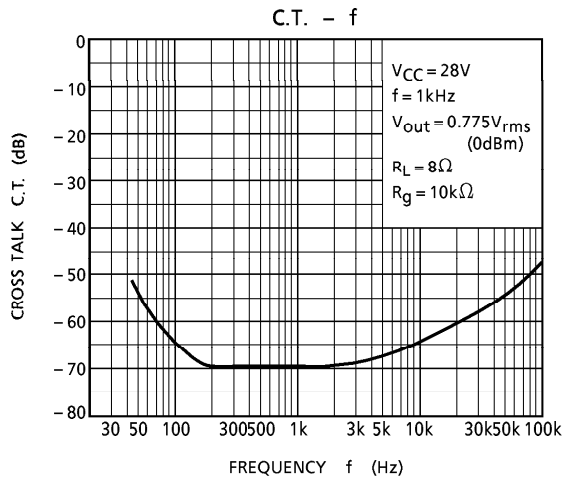

$I_{CCQ} - T_a$

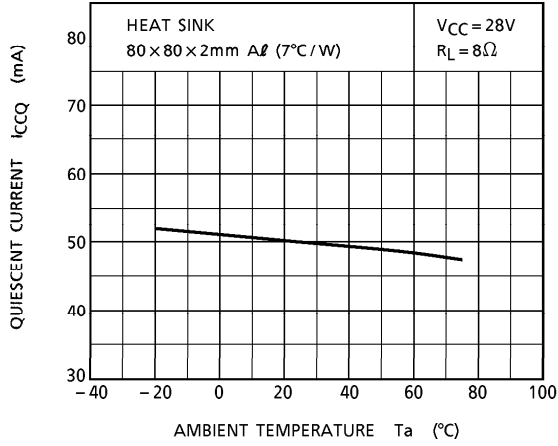

$V_{no} - T_a$

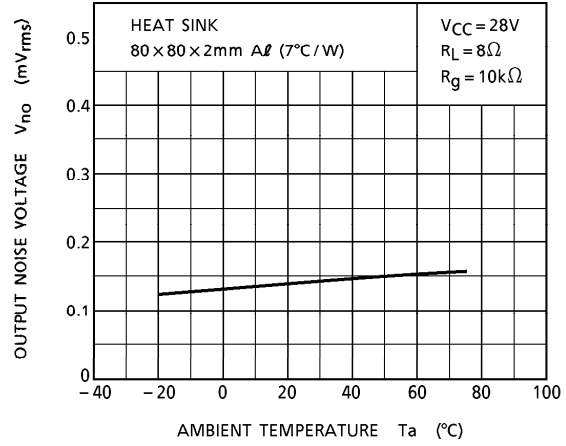

$P_D - P_{out}$

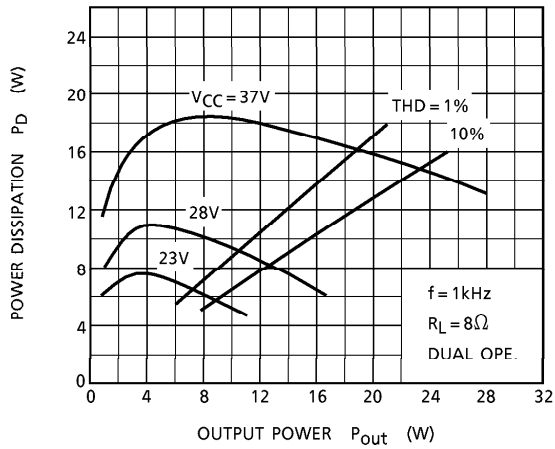

$P_D MAX - V_{CC}$

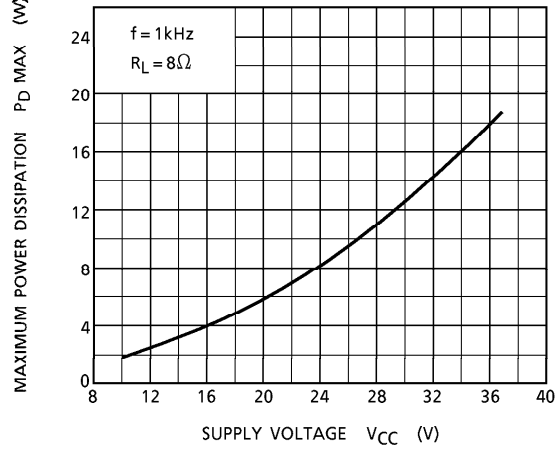

$P_D MAX - T_a$

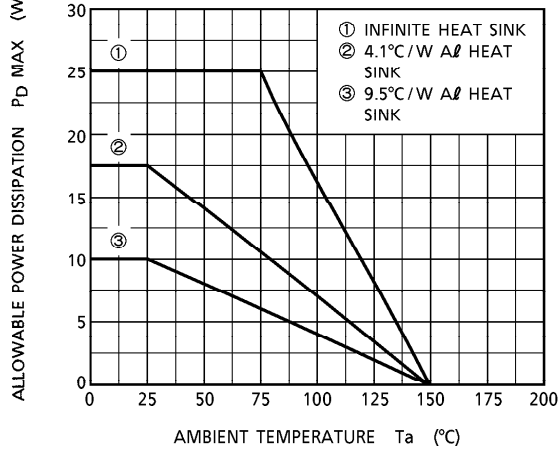

OUTLINE DRAWING
HZIP12-P-B

Unit : mm

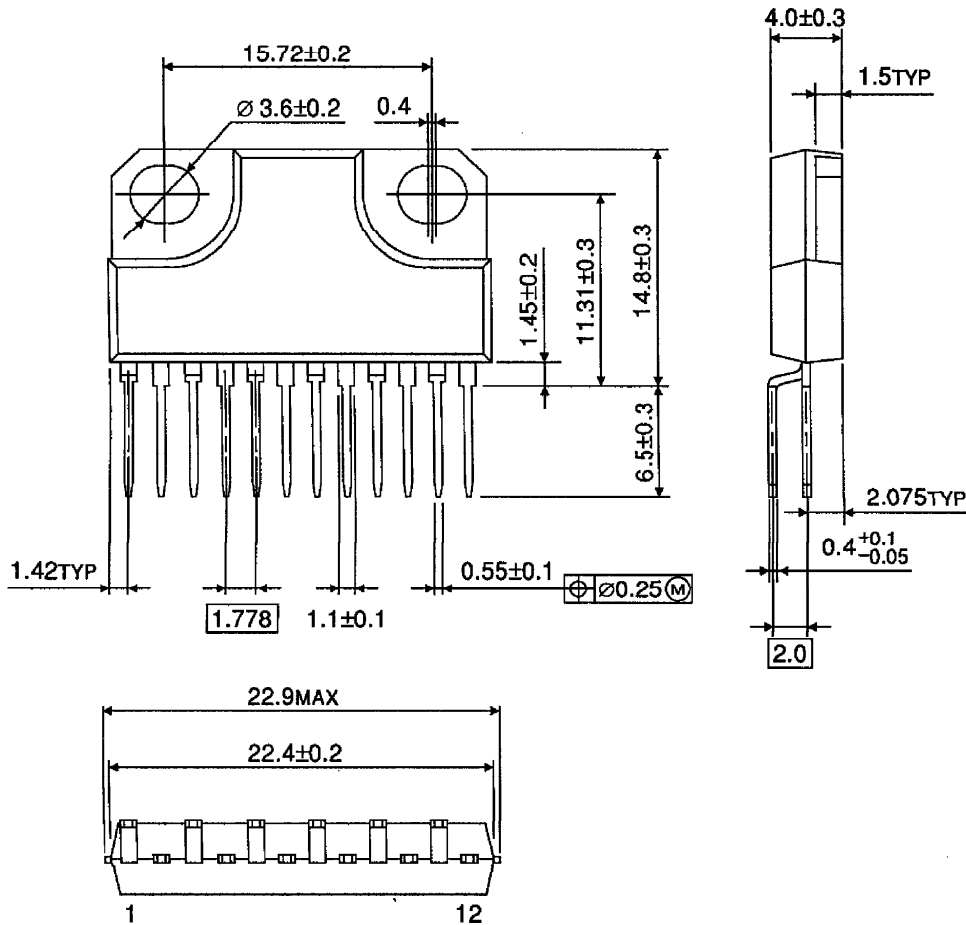

Weight : 4.04g (Typ.)