

TA8119P

STEREO HEADPHONE AMPLIFIER (3V USE)

The TA8119P is developed for play-back stereo headphone player (3V use), which is built-in preamplifiers, power amplifiers (for headphone) and DC volume controls.

FEATURES

- Built-in DC volume controls
- Coupling condenser-less for input of preamplifier
- The loop gain of power amplifier is 30dB (Typ.), in case that DC volume is at maximum
- Available of external input signal from DC volume stage
- Low quiescent current ($V_{CC} = 3V$, $T_a = 25^\circ C$)
 $I_{CCQ} = 9mA$ (Typ.)
- Operating supply voltage range ($T_a = 25^\circ C$)
 $V_{CC} (opr) = 1.8 \sim 6V$

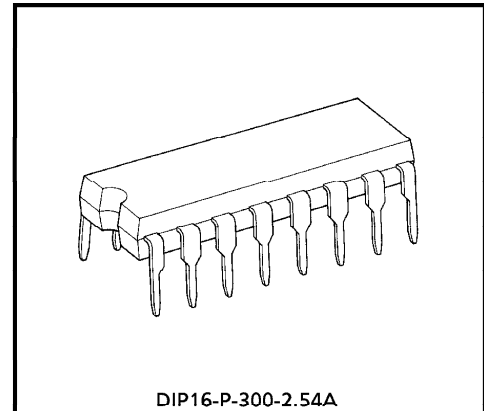

DIP16-P-300-2.54A

Weight : 1.00g (Typ.)

BLOCK DIAGRAM

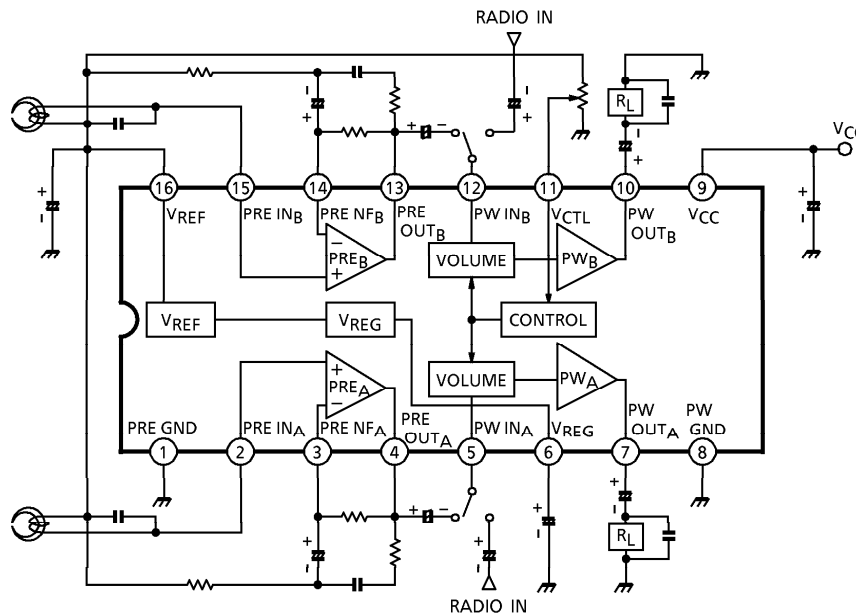

961001EBA2

● TOSHIBA is continually working to improve the quality and the reliability of its products. Nevertheless, semiconductor devices in general can malfunction or fail due to their inherent electrical sensitivity and vulnerability to physical stress. It is the responsibility of the buyer, when utilizing TOSHIBA products, to observe standards of safety, and to avoid situations in which a malfunction or failure of a TOSHIBA product could cause loss of human life, bodily injury or damage to property. In developing your designs, please ensure that TOSHIBA products are used within specified operating ranges as set forth in the most recent products specifications. Also, please keep in mind the precautions and conditions set forth in the TOSHIBA Semiconductor Reliability Handbook.

PIN FUNCTION

Terminal voltage : Typical terminal voltage at no signal with test circuit ($V_{CC} = 3V, T_a = 25^\circ C$)

PIN No.	PIN NAME	CONTENTS	EQUIVALENT	TERMINAL VOLTAGE (V)
1	PRE GND	—	—	0
2	PRE IN _A	Input of preamplifier		1.3
15	PRE IN _B			1.3
3	PRE NF _A	NF of preamplifier		1.3
14	PRE NF _B			1.3
4	PRE OUT _A	Output of preamplifier		1.3
13	PRE OUT _B			1.3
5	PW IN _A	Input of power amplifier for headphone (through DC volume stage)		1.3
12	PW IN _B			1.3
6	V _{REG}	Ripple filter of power supply		2.6
16	V _{REF}	Reference voltage		1.3
7	PW OUT _A	Output of power amplifier		1.3
10	PW OUT _B			1.3
8	PW GND	—	—	0
9	V _{CC}	—	—	3
11	V _{CTL}	Input of control voltage for volume control		—

961001EBA2'

● The products described in this document are subject to foreign exchange and foreign trade control laws.
 ● The information contained herein is presented only as a guide for the applications of our products. No responsibility is assumed by TOSHIBA CORPORATION for any infringements of intellectual property or other rights of the third parties which may result from its use. No license is granted by implication or otherwise under any intellectual property or other rights of TOSHIBA CORPORATION or others.
 ● The information contained herein is subject to change without notice.

APPLICATION NOTE

- (1) A volume which has the characteristic "curve A" is available for the DC volume control.
- (2) The capacitor C is used for absorbing volume sliding noise.
- (3) The DC volume control circuit is applicable to "Function of Mute", connecting as Fig.1.
In case of tuning mute-on, the load of "Reference voltage circuit" is R, at maximum volume.
- (4) Small temperature coefficient and excellent frequency characteristic is needed by capacitors below.
 - Oscillation preventing capacitors for power amplifier output.
 - Capacitor between V_{REF} and GND.
 - Capacitor between V_{CC} and GND.
 - Capacitor between V_{REG} and GND.

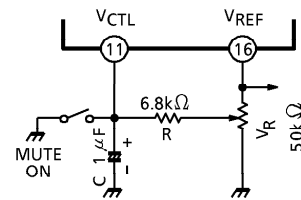

Fig.1 Function of mute

MAXIMUM RATINGS (Ta = 25°C)

CHARACTERISTIC	SYMBOL	RATING	UNIT
Supply Voltage	V_{CC}	7	V
Output Current	$I_{O(peak)}$	120	mA
Power Dissipation	P_D (Note)	750	mW
Operating Temperature	T_{opr}	- 25~75	°C
Storage Temperature	T_{stg}	- 55~150	°C

(Note) Derated above $T_a = 25^\circ\text{C}$ in the proportion of $6\text{mW}/^\circ\text{C}$.

ELECTRICAL CHARACTERISTICS

Unless otherwise specified, $V_{CC} = 3V$, $T_a = 25^\circ C$, $f = 1kHz$
 Preamplifier : $R_L = 10k\Omega$, Vol = MIN
 Power amplifier : $R_L = 32\Omega$, Vol = MAX

CHARACTERISTIC		SYMBOL	TEST CIRCUIT	TEST CONDITION	MIN.	TYP.	MAX.	UNIT
Quiescent Supply Current		I _{CCQ1}	—	V _{in} = 0, Vol = MIN	—	9.0	13.0	mA
		I _{CCQ2}	—	V _{in} = 0, Vol = MAX	—	11.0	—	
Preamplifier Section	Open Loop Voltage Gain	G _{VO}	—	V _O = -12dBV	55	62	—	dB
	Closed Loop Voltage Gain	G _{VC}	—	NAB = 1kHz, V _O = -12dBV	—	33	—	dB
	Maximum Output Voltage	V _{Om}	—	THD = 1%	600	720	—	mV _{rms}
	Total Harmonic Distortion	THD1	—	V _O = -12dBV	—	0.04	0.1	%
	Equivalent Input Noise Voltage	V _{ni}	—	R _g = 2.2kΩ BPF = 30Hz~20kHz NAB (G _V = 33dB, f = 1kHz)	—	1.2	2.0	μV _{rms}
	Ripple Rejection Ratio	RR1	—	R _g = 2.2kΩ V _r = -22dBV, f _r = 100Hz	—	46	—	dB
Power Amplifier Section	Output Power	(1)	P _{O1}	—	THD = 10%	20	27	mW
		(2)	P _{O2}	—	R _L = 16Ω, THD = 10%	—	39	
	Voltage Gain (1)	G _{V1}	—	V _O = -12dBV	28	30	32	dB
	Channel Balance	CB			—	0	1.5	dB
	Voltage Gain (2)	G _{V2}	—	V _O = -12dBV, Vol = MID	—	15	—	dB
	Total Harmonic Distortion	THD2	—	P _O = 10mW	—	0.5	1.2	%
		THD3			P _O = 10mW, Vol = MID	—	0.3	
	Output Noise Voltage	V _{no}	—	R _g = 600Ω BPF = 30Hz~20kHz	—	250	320	μV _{rms}
	Maximum Attenuation	ATT	—	V _O = -12dBV Vol = MAX→MIN	66	72	—	dB
Ripple Rejection Ratio	RR2	—	R _g = 600Ω V _r = -22dBV, f _r = 100Hz	—	46	—	dB	
Total	Cross Talk (CH-A / CH-B)	CT	—	R _g = 2.2kΩ V _O = -12dBV, Vol = MAX	34	40	—	dB

TEST CIRCUIT

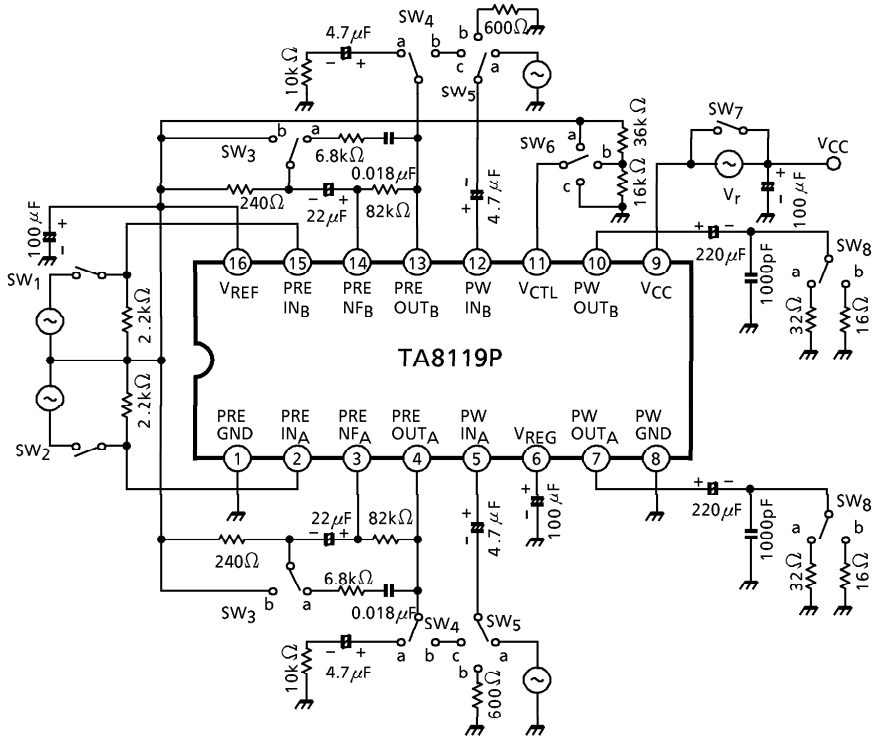

SWITCH STATE FOR ELECTRICAL CHARACTERISTICS

CHARACTERISTIC	SW ₁	SW ₂	SW ₃	SW ₄	SW ₅	SW ₆	SW ₇	SW ₈
I _{CCQ1}	x	x	a	a	b	c	○	a
I _{CCQ2}	x	x	a	a	b	a	○	a
G _{VO}	○	○	b	a	b	c	○	a
G _{VC}	○	○	a	a	b	c	○	a
V _{om}	○	○	a	a	b	c	○	a
THD1	○	○	a	a	b	c	○	a
V _{ni}	x	x	a	a	b	c	○	a
RR1	x	x	a	a	b	c	x	a
P _{o1}	x	x	a	a	a	a	○	a
P _{o2}	x	x	a	a	a	a	○	b
G _{V1}	x	x	a	a	a	a	○	a
CB	x	x	a	a	a	a	○	a
G _{V2}	x	x	a	a	a	b	○	a
THD2	x	x	a	a	a	a	○	a
THD3	x	x	a	a	a	b	○	a
V _{no}	x	x	a	a	b	a	○	a
ATT	x	x	a	a	a	a→c	○	a
RR2	x	x	a	a	b	c	x	a
CT	○ / x	x / ○	a	b	c	a	○	a

○ : short x : open

CHARACTERISTIC CURVES

Unless otherwise specified : $V_{CC} = 3V$, $f = 1kHz$, $T_a = 25^\circ C$

Preamplifier : $R_L = 10k\Omega$, Vol = MIN

Power Amplifier : $R_L = 32\Omega$, Vol = MAX

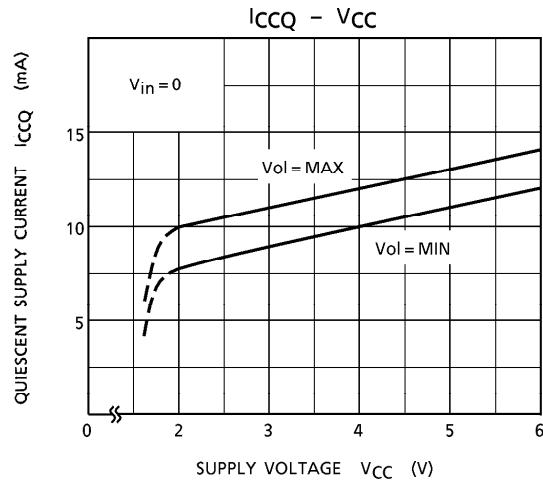
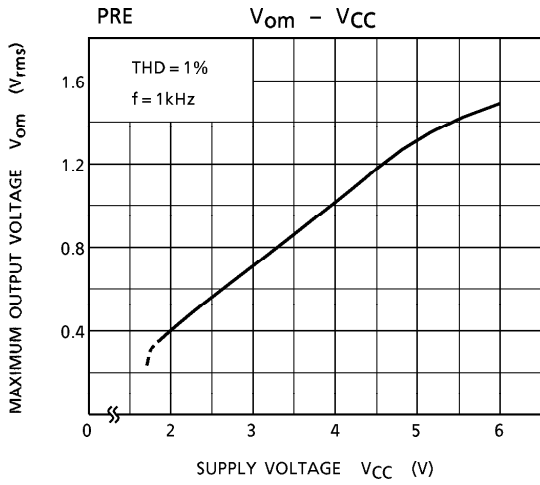
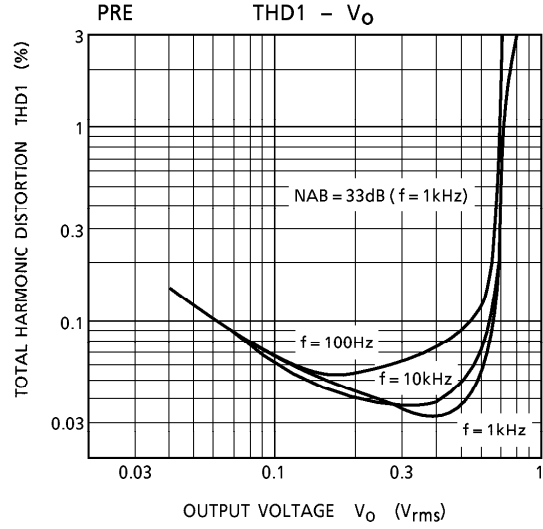
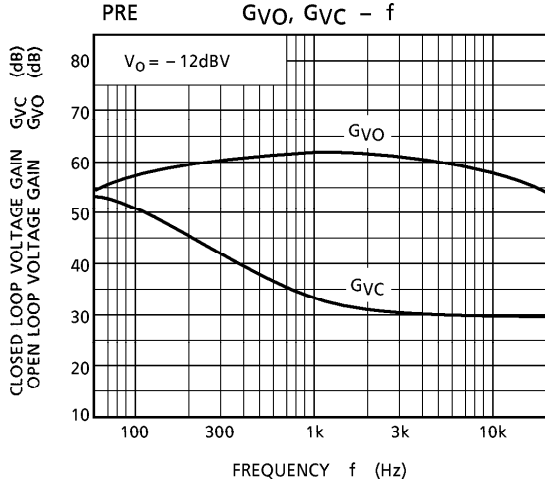

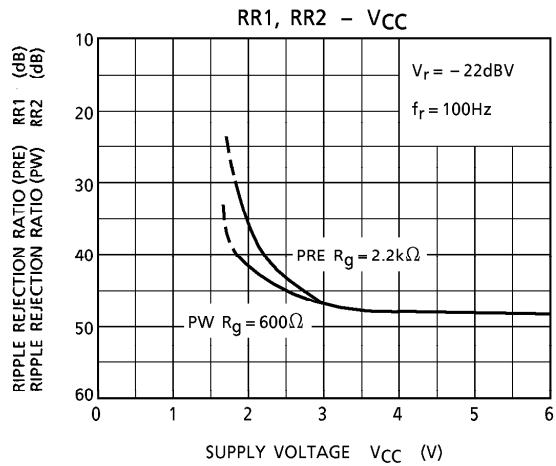
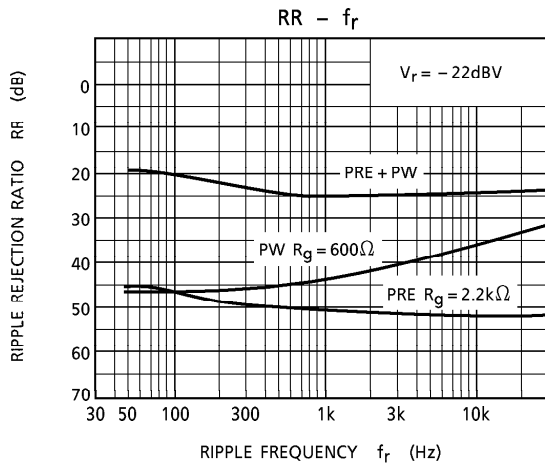
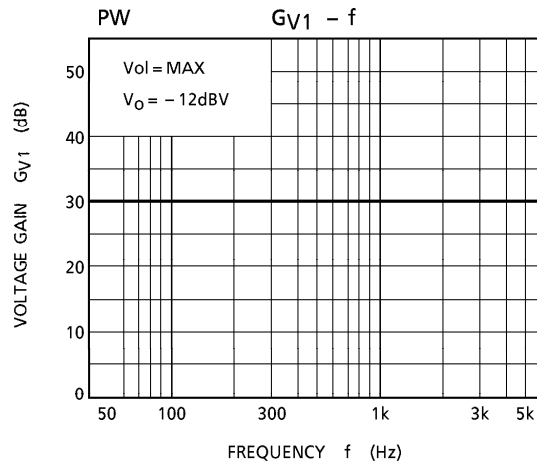
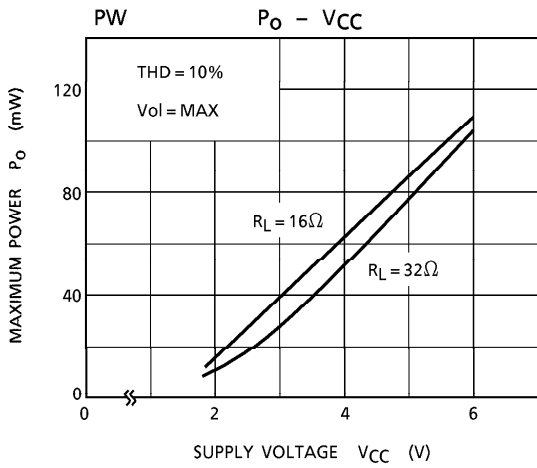
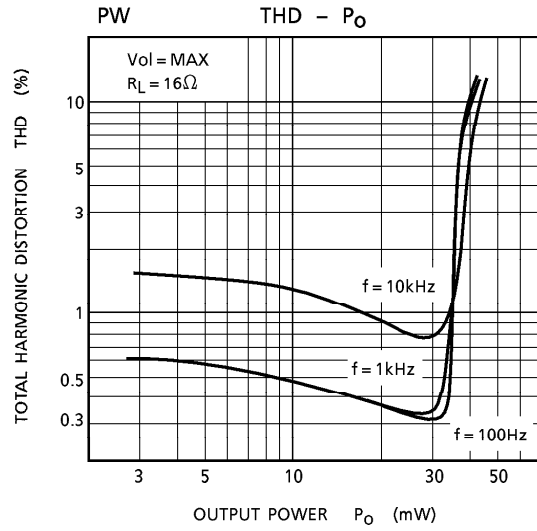
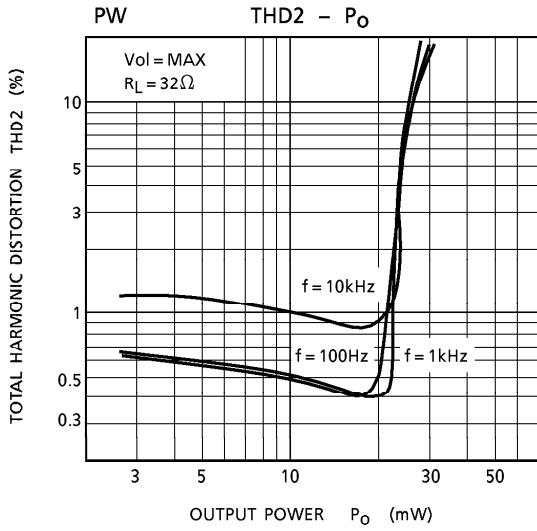

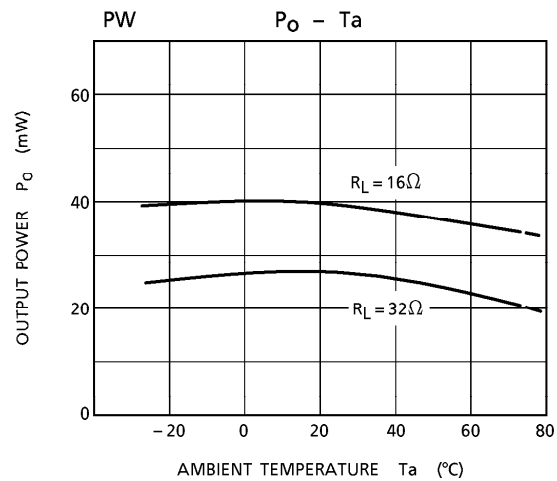
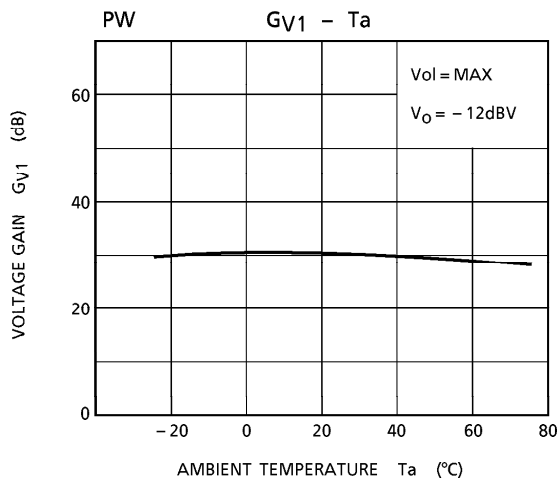
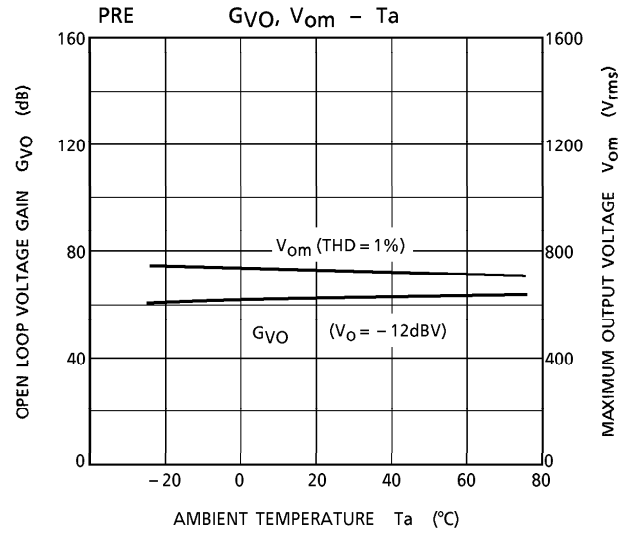
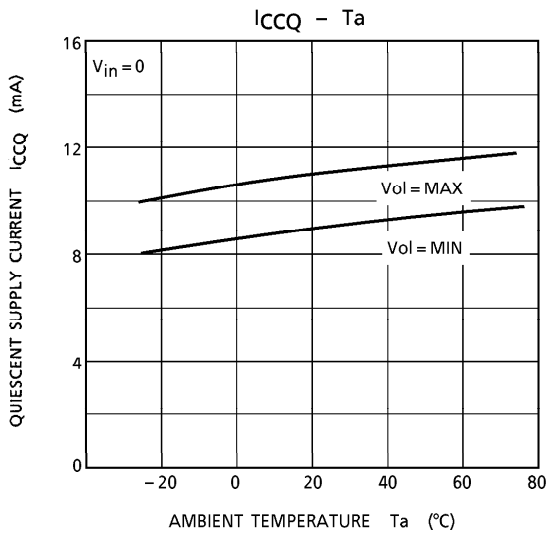
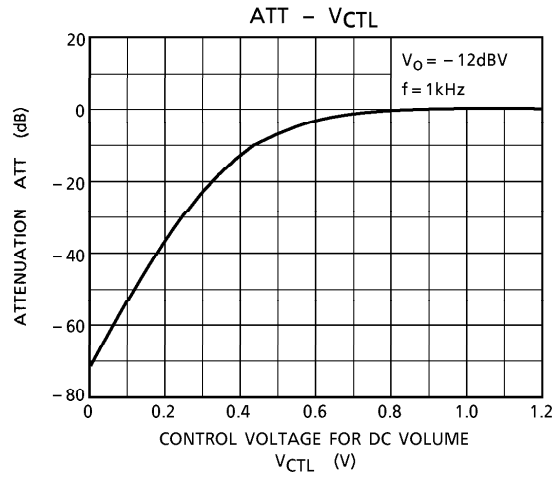
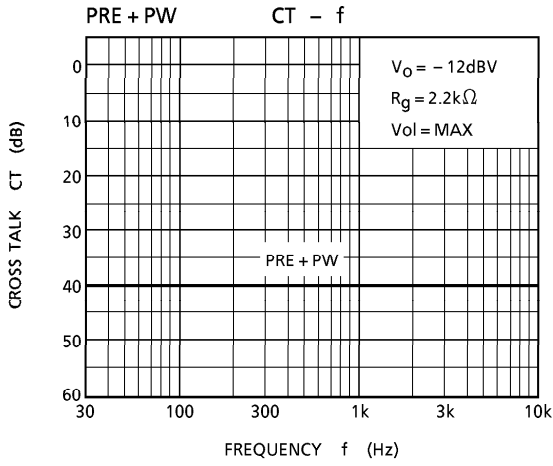

OUTLINE DRAWING
DIP16-P-300-2.54A

Unit : mm

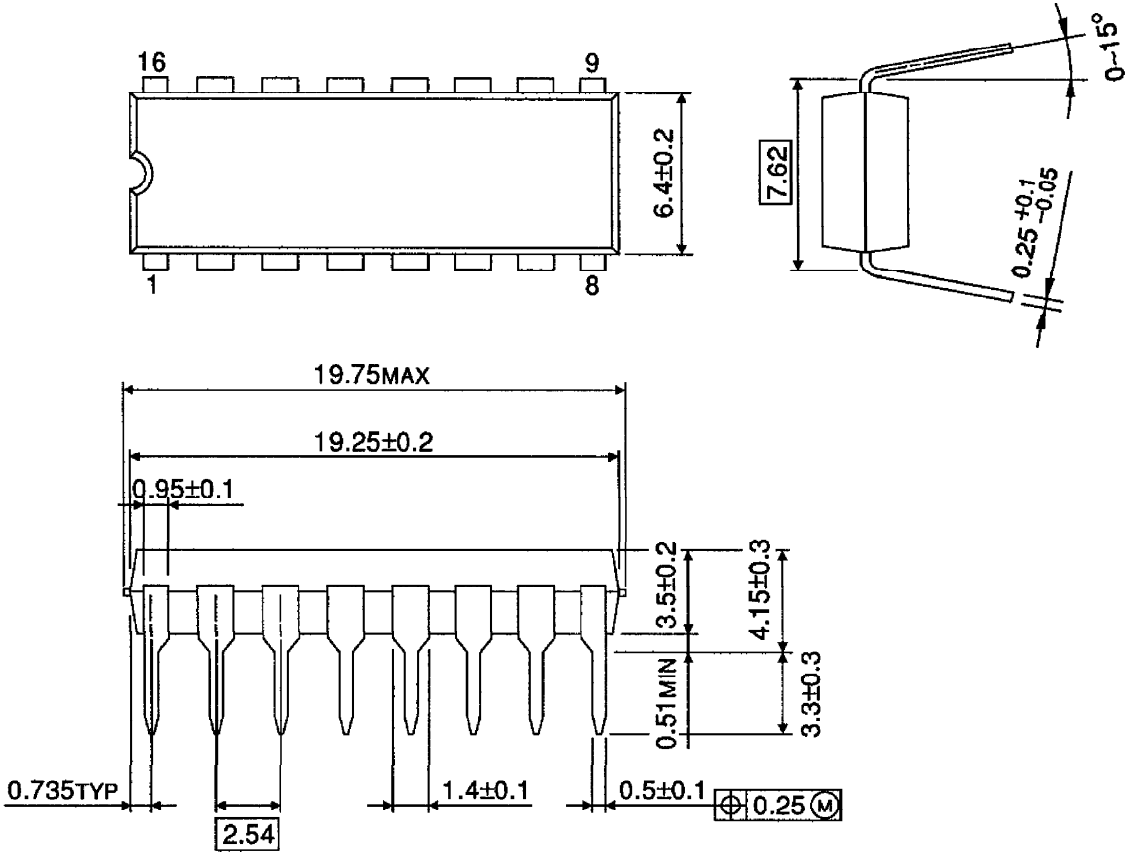

Weight : 1.00g (Typ.)