

AN6157NK

Speech Network Circuit

Overview

The AN6157NK is a speech network IC with a side tone preventive circuit network switching function. It enables manual/automatic switching and realizes good side-tone characteristics under any line conditions, including communications through the extension.

Features

- Capable of interfacing with the light-weight small ceramic receivers and low-impedance dynamic receivers.
- Capable of interfacing with the ECM transmitters.
- Built-in ECM constant voltage source (2.1V typ.)
- Built-in 2-channel side tone circuit network switching function according to a line current and capable of manual switching in communications through the extension.
- Automatic gain control according to a line current and manual gain control also available.
- Built-in key-in-tone amplifier and DTMF transmission circuit to allow mode setting through a control pin.
- 22-pin DIL (shrunk type) plastic package.

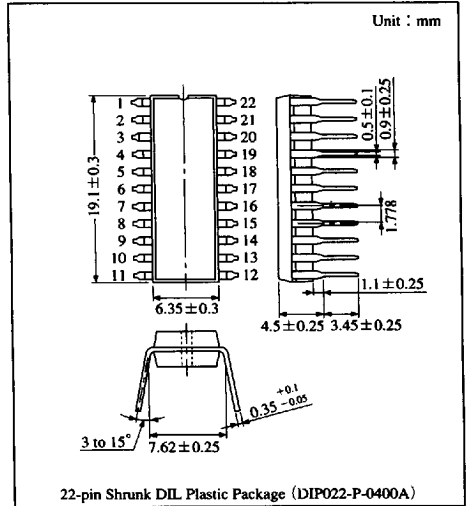

Block Diagram

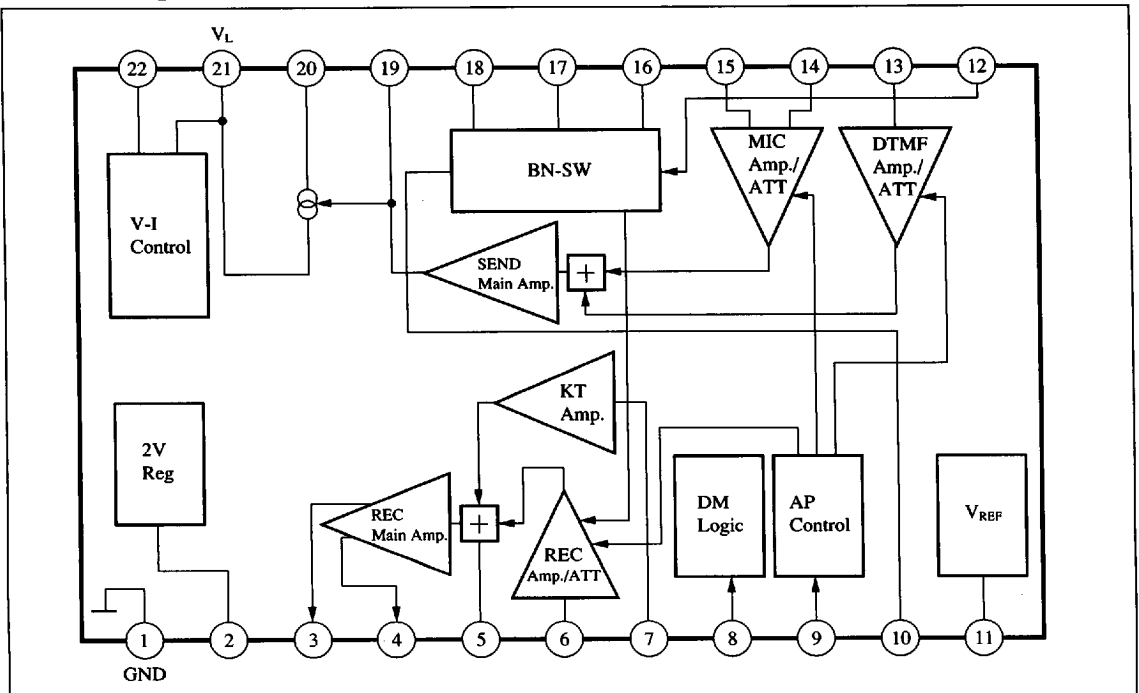

6932852 0013052 9T4

Panasonic

ICs for Telephone

■ Absolute Maximum Ratings (Ta=25°C)

Parameter	Symbol	Rating	Unit
Supply voltage	V _L	14.4	V
Supply current	I _L	120	mA
Power dissipation (Ta=60°C)	P _D	1440	mW
Operating ambient temperature	T _{opr}	-20 to +75	°C
Storage temperature	T _{stg}	-55 to +150	°C

■ Recommended Operating Range (Ta=25°C)

Parameter	Symbol	Range
Operating supply voltage range	V _L	3 to 11.5V

■ Electrical Characteristics (I_L (Line Current) = 30mA, Input Signal Frequency f_{in} = 1kHz, Ta = 25°C)

Parameter	Symbol	Condition	min	typ	max	Unit
Receiver System						
Receiver gain	G _{V-R}	Input a signal to the Pin(2). Connect a resistor (3kΩ) and a capacitor (0.055μF) between the Pins(3) and (4), and measure the output between the capacitors.	8.5	11	13.5	dB
Receiver automatic pad	A _{P-R}	Input a signal (-26dBV) to the Pin(2). Measure an output change (both ends of the capacitor) when changing I _L from 30mA to 80mA.	-4.8	-3.4	-2.3	dB
Maximum receiver level	V _{O-R}	Input a signal to the Pin(2) and measure the output when an output distortion factor is 5%.	-3	0	—	dBV
KEY IN TONE gain	G _{V-KT}	Ground the Pin(3). Measure the receiver output when inputting a signal (-42dBV) to the Pin(2).	11.5	14	16.5	dB
Transmitter System						
Transmitter gain (1)	G _{V-T}	Input a signal (-47dBV) to the Pin(5) and measure a transmission signal at a 600Ω load eed between the Pin(2) and GND.	37	39	41	dB
Transmitter automatic pad	A _{P-T}	Input a signal (-47dBV) to the Pin(5). Measure a change of transmission signal (600Ω end) when changing I _L from 30mA to 80mA.	-5.3	-3.7	-2.5	dB
Maximum transmission level	V _{O-T}	Input a signal to the Pin(5) and measure the output when the output distortion factor of a transmission signal (600Ω end) is 5%.	-5	-1.4	—	dBV
DTMF gain	G _{V-DT}	Ground the Pin(8). Input a signal (-37dBV) to the Pin(3) and measure a transmission signal (600Ω end).	25	27	29	dB
DTMF automatic pad	A _{P-DT}	Ground the Pin(8). Input a signal (-37dBV) to the Pin(3) and measure an output change when I _L changes from 30mA to 80mA.	-5	-3.4	-2.2	dB
DTMF maximum transmission level	V _{O-DT}	Ground the Pin(8). Input a signal to the Pin(3) and measure the output when the output distortion factor of a transmission signal (600Ω end) is 5%.	-5	-1.2	—	dBV
Power Supply						
DC line voltage (1)	V _{L-1}	Pin(2) DC voltage when I _L = 20mA	2.5	3.1	3.7	V
DC line voltage (2)	V _{L-2}	Pin(2) DC voltage when I _L = 120mA	5.5	7.5	11.5	V
Internal supply voltage (1)	V _{CC}	Pin(2) DC voltage when I _L = 20mA	1.8	2.08	2.4	V
Internal supply voltage (2)	V _{REF}	Pin(1) DC voltage when I _L = 20mA	0.88	1.03	1.18	V

■ 6932852 0013053 830 ■

Panasonic

Pin Descriptions

Pin No.	Pin name	Typical waveform	Description	Equivalent circuit
1	GND	DC 0V	Ground pin. Connect to the - output of the diode bridge.	
2	2V REG	DC 2V	2V internal stabilized power output pin. Connect to GND via 220 μF.	
3 4	REC OUT	1V 1V	Receiver output pin. The Pins ③ and ④ are of BTL output.	
5	REC filter	1V	Receiver filter pin. Between the receiver pre-amplifier step and output amplifier step. The input impedance is 2k Ω.	
6	REC IN	1V	Receiver input pin. A signal is output to the Pins ③, ④ and ⑤ when DM (Pin ⑧) is at the H level, and not output when at the L level.	
7	Key In tone IN	1V	KT signal input pin. A signal is output to the Pins ③, ④ and ⑤ when DM (Pin ⑧) is at the L level, and not output when at the H level.	
8	Dial mute SW	0V Mute	Dial mute SW pin. Switches between the transmission signals (MIC, DTMF) and reception signals (REC, KT). MIC and REC are output at the high level, and KT and DTMF are output at the low level.	
9	Auto pad control	DC 0 to 2V	Automatic pad control pin. Connect a resistor between the Pin ② and this pin. Adjust the circuit current characteristic of the pad depending on an external resistance value. Connecting this pin to Vcc maximizes the gain, and setting it to the Low level minimizes the gain. (manual pad)	
10	BN-SW VL	DC 3 to 8V	BN Circuit power pin. Connect a resistor (typ. 820 Ω) between VL (Pin ⑩) and a capacitor (typ. 220 μF) between GND and this pin.	
11	VREF	DC 1V	1V internal stabilized power output pin. Reference voltage to determine the operating point of the internal circuit. No power input/output is allowed to this pin.	

6932852 0013055 603

Panasonic

Pin Descriptions (cont.)

Pin No.	Pin name	Typical waveform	Description	Equivalent circuit
12	BN control	DC 0 to 2V	BN control pin. Connect resistor between the Pin② and this pin. Switches BN with the voltage generated at this pin. If this pin is connected to 2V, the BN-2 (for far end) side tone preventive circuit network is connected, and if set to the Low level, the BN-1 (for near end) side tone preventive circuit network is connected.	
13	DTMF IN		DTMF signal input pin. Input a DTMF signal from the dialer, etc. It is sent to the circuit when DM (Pin⑧) is at the L level, and not sent when at the H level.	
14 15	MIC IN		MIC input pin. Microphone input pin. The Pins⑭ and ⑮ are of differential input and sent to the circuit when the DM (Pin⑧) is at the H level, and not sent when at the L level.	
16 17 18	BN OUT BN-1 BN-2		BN output pin (Pin⑯). BN connection pins (Pins⑰ and ⑱). Switches the circuit network between the Pin⑲ and Pin⑰ and Pin⑱. Connect the near end BN circuit to the Pin⑰ and the far end BN circuit to the Pin⑱.	
19	SEND filter		Transmission filter pin. A transmission system L.P.F consists of capacitors connected between this pin and GND.	
20	Side tone		Transmitter output pin. Connect a resistor between GND and this pin. The transmitter system gain changes depending on this resistance value. A circuit output inverting signal is output.	
21	V _L		Circuit input pin. Connect to the + output of the diode bridge.	
22	V _{LC}	DC 1 to 6V	Circuit voltage control pin. Connect a resistor and a capacitor between this pin and V _L (Pin⑳), and a resistor between this pin and GND. The DC characteristics of V _L can be adjusted depending on a resistance value.	

6932852 0013056 54T

Panasonic

ICs for Telephone

■ Characteristics Curve

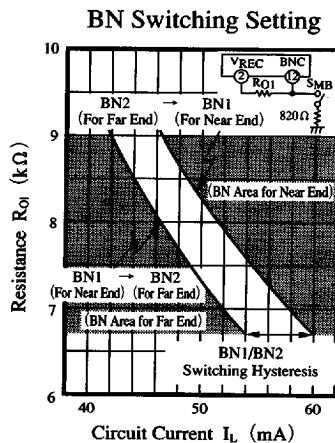
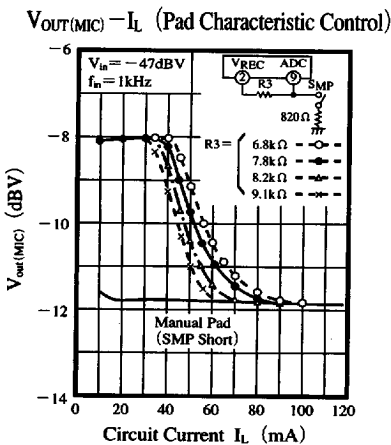
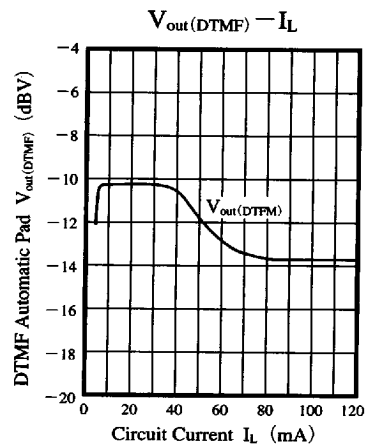
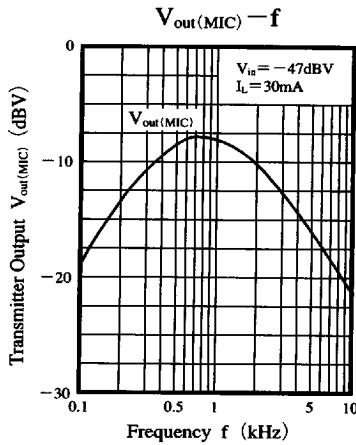
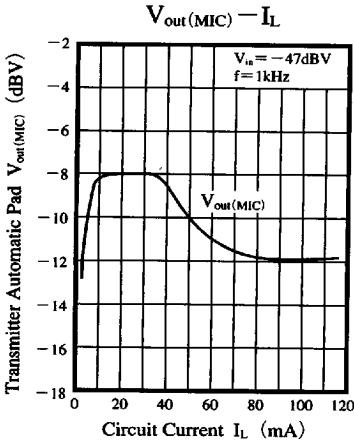
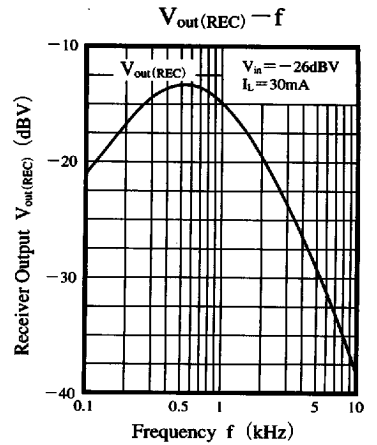
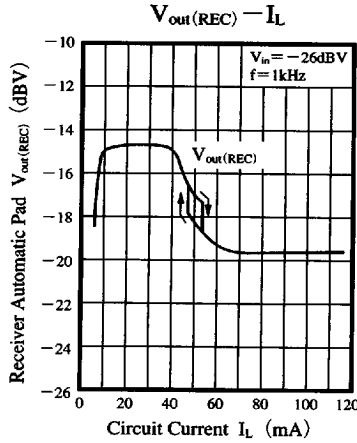
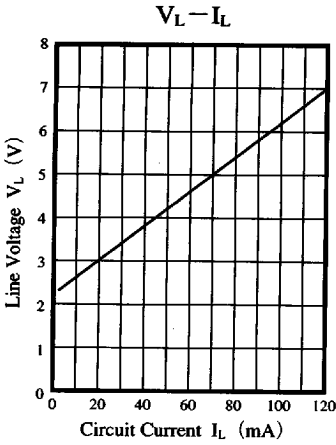

■ 6932852 0013057 486 ■